

Technische Daten

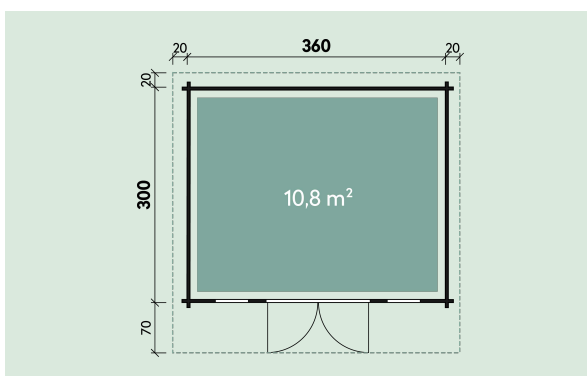

Artikelnummer:

846 200, 831 361, 831 362, 831 363, 831 364



Kontrolliert durch:

3D-Darstellung und Grundriss

846 200, 831 361, 831 362, 831 363, 831 364

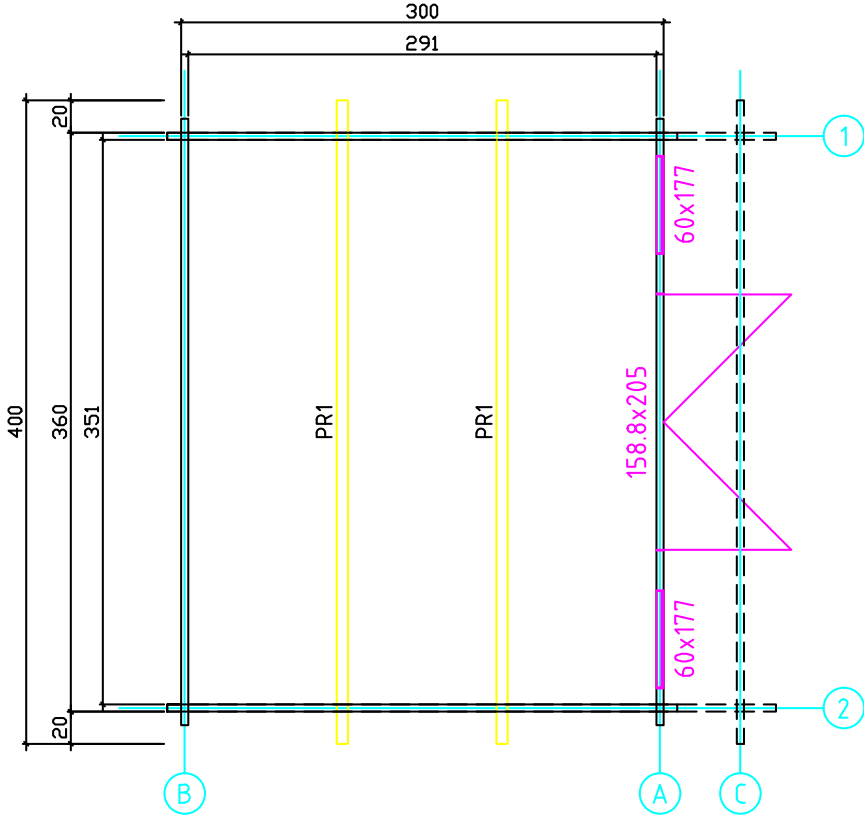
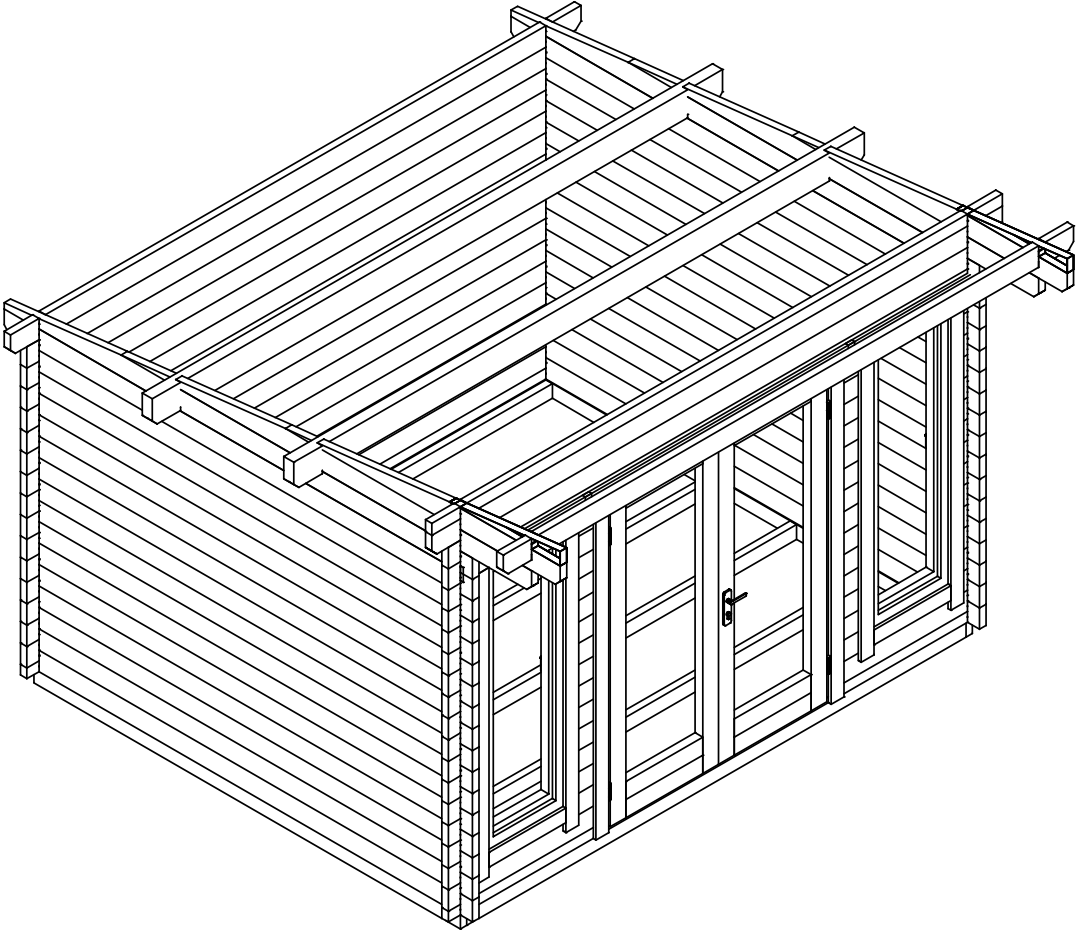

Lagerholzplan und Fundamentplan





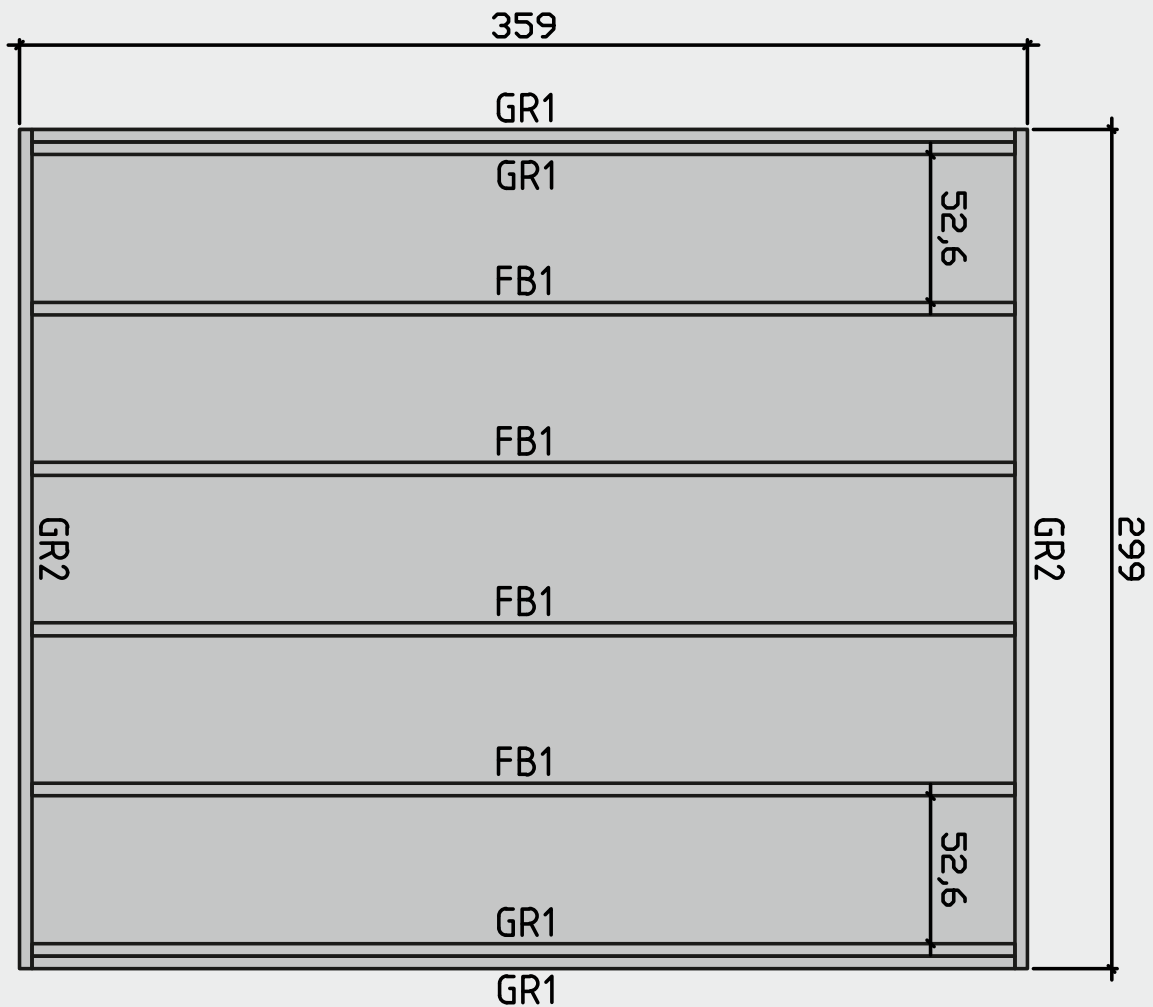





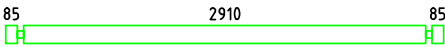
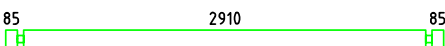

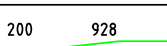
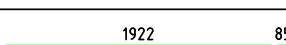
846 200, 831 361, 831 362, 831 363, 831 364

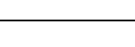
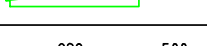
Wir empfehlen als Fundament für Ihr Gartenhaus eine vollflächig festgegründete, gepflasterte oder betonierte Fläche.
Wahlweise ist auch ein Punkt- oder Streifenfundament möglich.

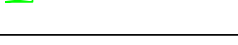
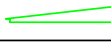
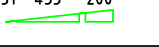
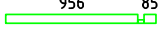
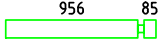

Teileliste 1

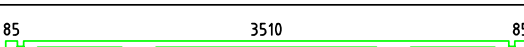
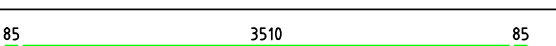
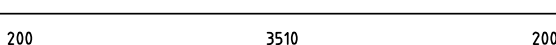
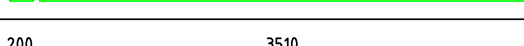
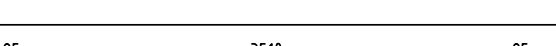
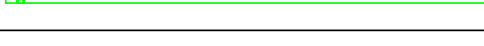
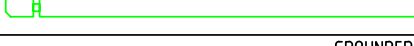
846 200, 831 361, 831 362, 831 363, 831 364

Pos		Quantity	Profil (mm)	Lenght (mm)
001		2	45x130	3170
002		28	45x130	3170
003		2	45x130	3285
004		2	45x130	1173
005		2	45x130	2052
006		2	45x40	352
007		2	45x130	963
008		2	45x130	1473
009		2	45x22	194
010		2	45x130	1703
011		2	45x88	776
012		2	45x65	1086
013		2	45x130	1086
014		2	45x130	1086
015		26	45x130	230
016		26	45x130	246
017		1	45x130	3770
018		16	45x130	3770
019		1	45x130	4000
020		1	45x74	4000
021		1	45x65	3770
022		2	45x130	4000
GR1	GROUNDFRAME 	4	45x90	3500
GR2	GROUNDFRAME 	2	45x90	2990
FB1	FLOORBEAMS 	4	45x90	3500

Teileliste 3

846 200, 831 361, 831 362, 831 363, 831 364

POS	ST.	B	H	L	Teileliste		
FB1	Vt. spetsi					FUNDMENTHOLZER	
F1	10,2m ²	28		2905		FUSSBODENBRETTER	
PR	2	70	170	4000		DACHBALKEN	
RB1	15,7m ²	20		3925		DACHBRETTER	
R1	2	20	140	4040		Traufenbretter	
R2	2	45	65	4000		Traufenbretter	
R3	2	20	140	4120		Giebelabschlussleiste	
R4	2	20	90	4120		Giebelabschlussleiste	
DR1 WN1	1 2	1588 600	2050 1770				
P1	14m	20	40			Fußbodenleiste	
P2	1+1	20	90	3500		Türleiste DR1, Fensterleiste WN1	
P3	2+2	20	90	2030		Türleiste DR1	
P4	4+4	20	90	1920		Fensterleiste WN1	
P5	2+2	20	90	540 570		Fensterleiste WN1	

Wandplan 1 und 2

846 200, 831 361, 831 362, 831 363, 831 364

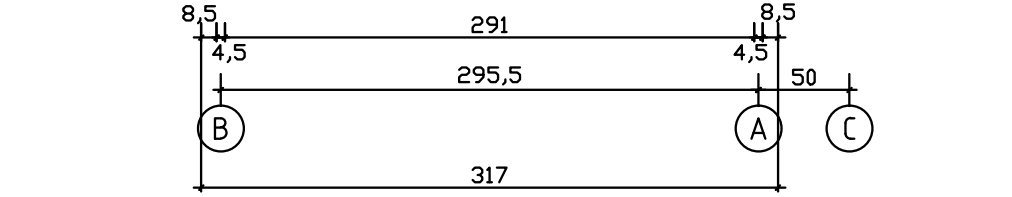
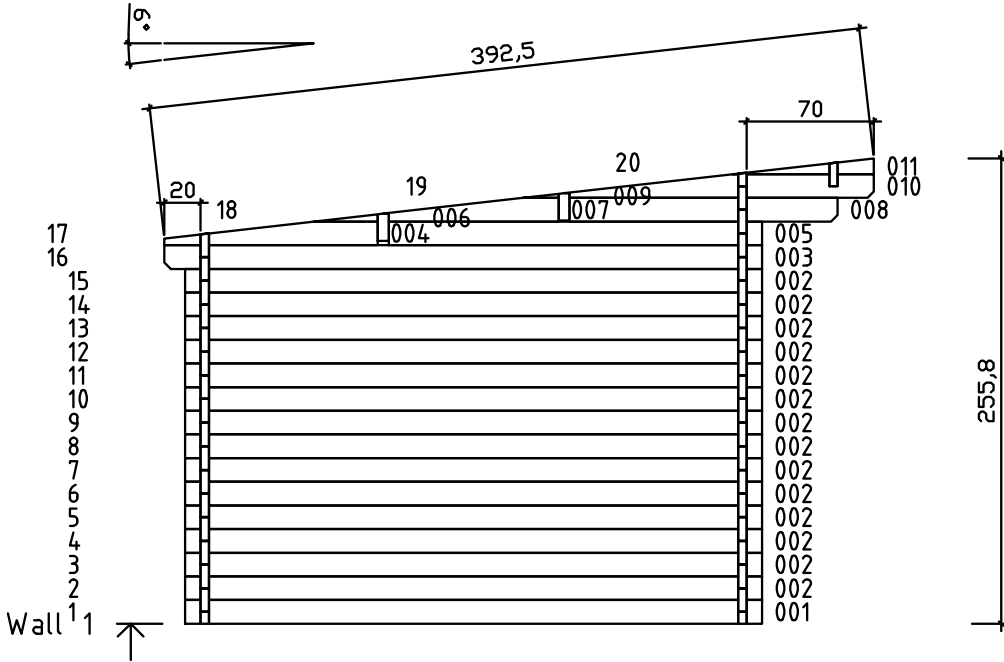

Wandplan A und B

846 200, 831 361, 831 362, 831 363, 831 364

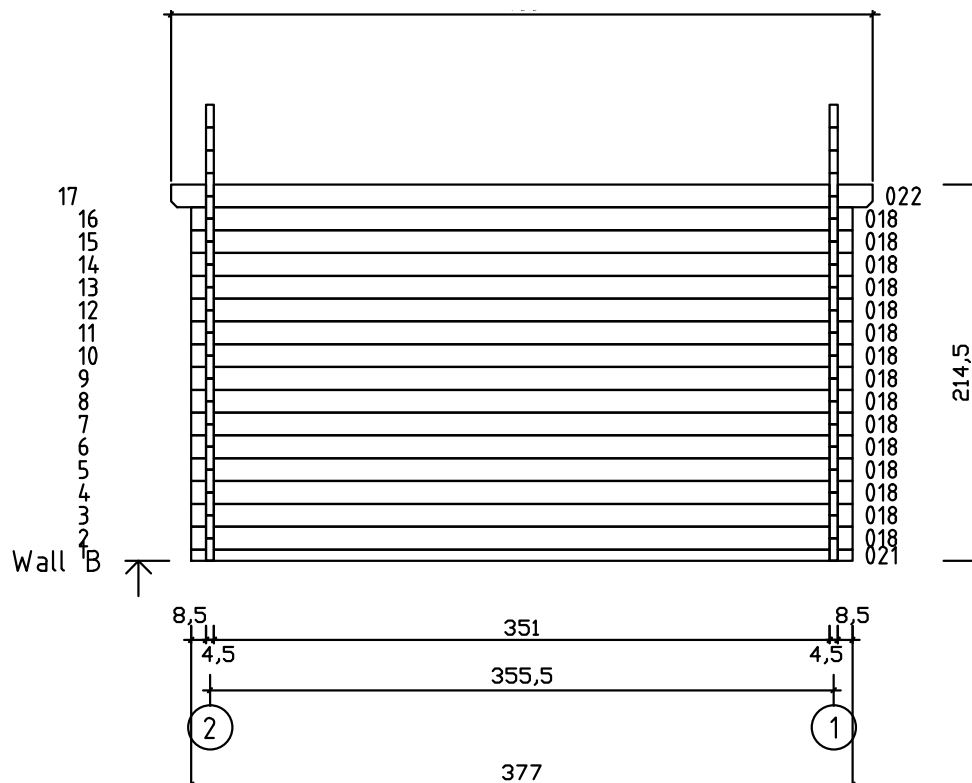
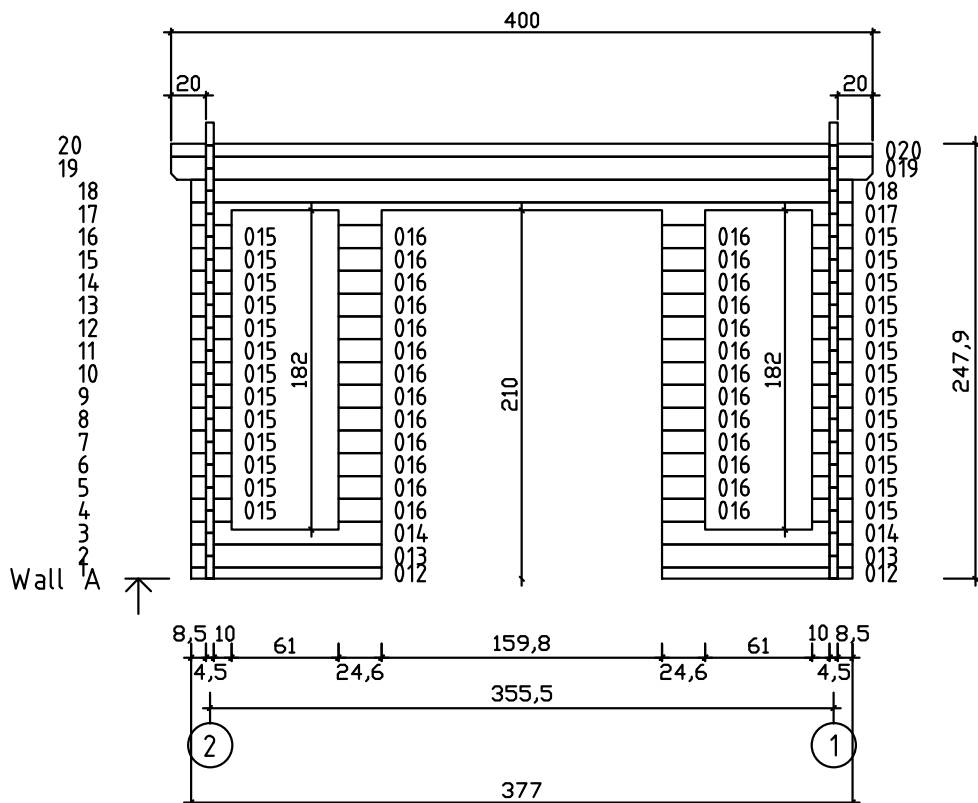

Wandplan C

846 200, 831 361, 831 362, 831 363, 831 364

