

Technische Daten: Art.-Nr.: 846070

Wandaußenmaß: 500 x 400 cm

Bohlenstärke: 44 mm



Kontrolliert durch:

Empty rectangular box for signature or name.

Achtung: Alle angegebenen Maße sind ca.-Maße!

3D-Darstellung und Grundriss 846070

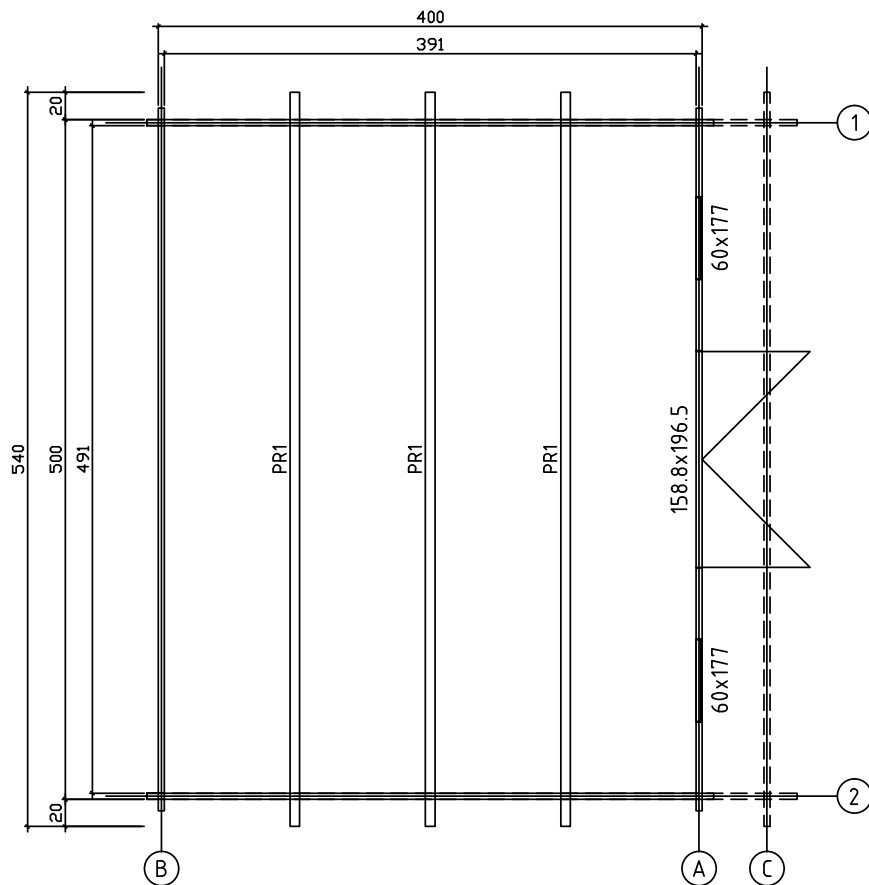
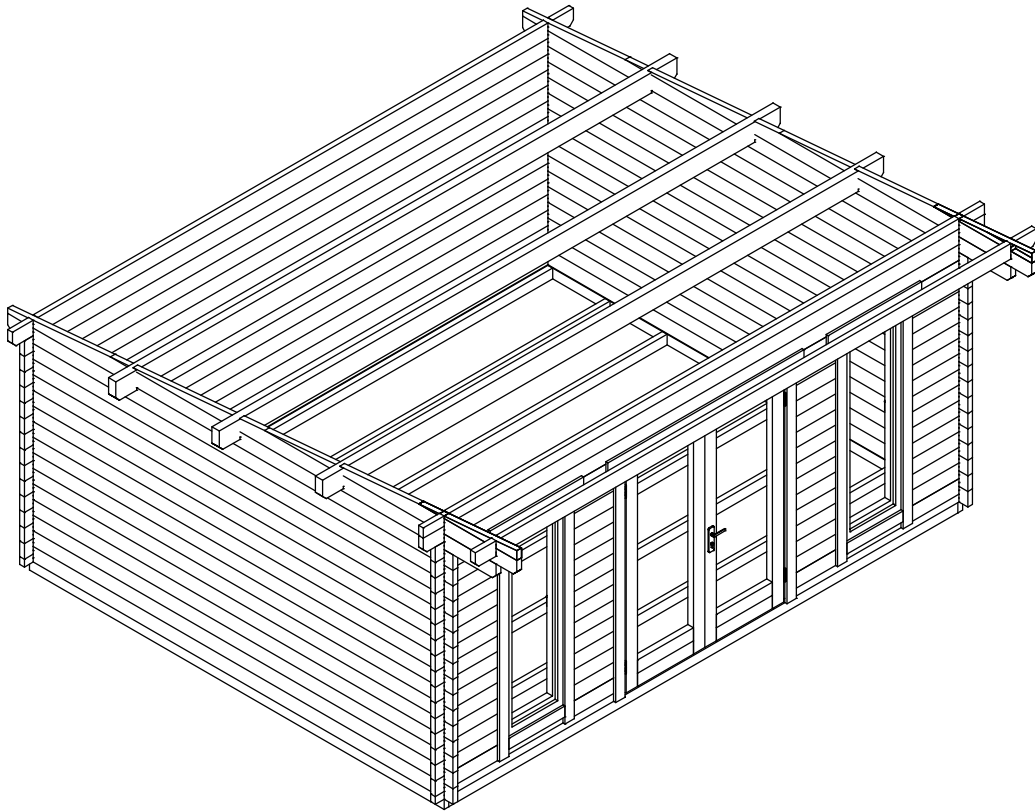

Lagerholzplan und Fundamentplan 846070

Wir empfehlen als Fundament für Ihr Gartenhaus eine vollflächig festgegründete, gepflasterte oder betonierte Fläche.
Wahlweise ist auch ein Punkt- oder Streifenfundament möglich.

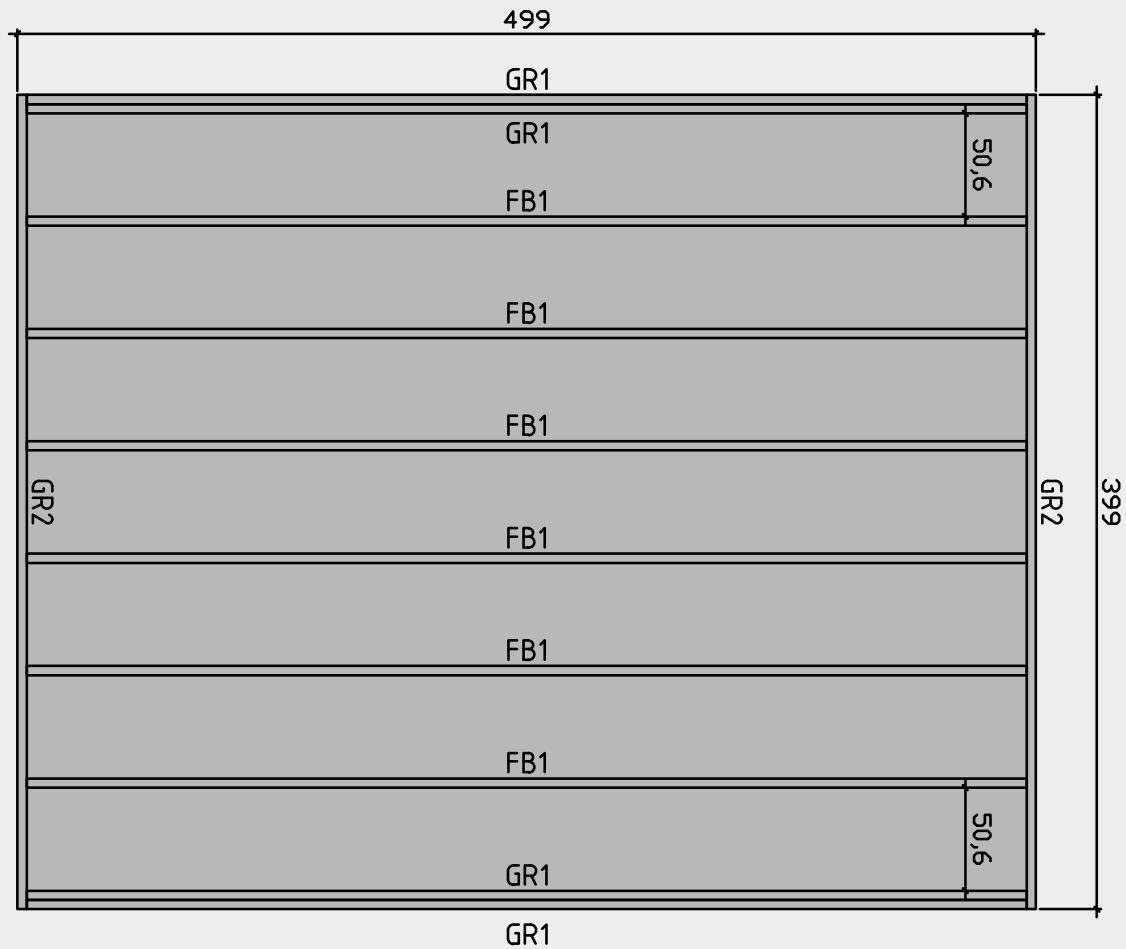









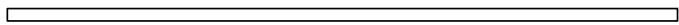

Teileliste 1

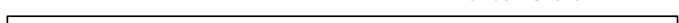
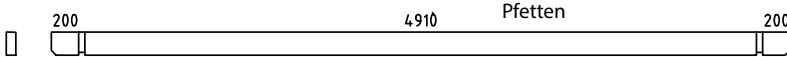
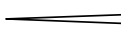
846070

Pos		Quantity	Profil (mm)	Lenght (mm)
001		2	45x130	4170
002		2	45x130	4170
003		24	45x130	4170
004		2	45x130	4285
005		2	45x130	1175
006		2	45x130	3050
007		2	45x16	188
008		2	45x104	965
009		2	45x130	2470
010		2	45x61	693
011		2	45x130	1705
012		2	45x83	943
013		2	45x65	1786
014		1	45x130	1786
015		1	45x130	1786
016		28	45x130	653
017		28	45x130	523
018		1	45x130	5170
019		1	45x130	5400
020		1	45x86	5400
021		1	45x65	5170
022		1	45x130	5170
023		13	45x130	5170
024		1	45x130	5400
025		1	45x130	5400

Teileliste 2

846070

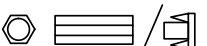
Pos		Quantity	Profil (mm)	Lenght (mm)
GR1	Rahmen-Fundamentholz 	4	45x90	4900
GR2	Rahmen-Fundamentholz 	2	45x90	3990
FB1	Fundamentholz 	6	45x90	4900
PR1	Pfetten 	3	70x170	5400
	Fenster 600x1770	2		
	Tür 1588x1965	1		
1	Screws/Schrauben/Vis 5x100 mm- For fixing first row of wall logs /Fixierung des ersten Bohlenkranzes/Pour fixer les lamesde plancher 	6		
2	Nails/Nägel/Clous 2.5x50 - For fixing floorboards/ Befestigung Fussbodenbretter/Pour fixer les lames de plancher 	450		
3	Nails/Nägel/Clous 2.5x50 - For fixing roofboards/ Befestigung Dachbretter/Pour fixer les voliges 	400		
4	Nails/Nägel/Clous 2.5x50 - For fixing floor edge trims/ Befestigung Fussleisten/Pour fixer les plinthes du plancher 	40		
5	Nails/Nägel/Clous 2.5x50 - For fixing roofing felt fillet/ Befestigung giebelabschlussbrett/Pour fixer la latte de finition de la couverture 	40		
6	Screws/Schrauben/Vis 2,5x50 mm- For fixing roof side boards and roof edge reinforcement Befestigung Traufenbretter und Traufenleisten Pour fixer les planches de rive et le tasseau de refront 	150		
7	Screws/Schrauben/Vis 2,5x50 mm- For fixing fascia boards and diamonds/ Befestigung Giebelblende und Raute Pour fixer les planches de rive et le diamant 			
8	Screws/Schrauben/Vis 2,5x50 mm- For fixing fwindow and door trims/ Befestigung Fenster und türen/ Pour fixer les croisillons des fenetres et des portes 			
9	Metal storm Brace/Gewindestange/Tige filetee 8 mm 	5		
10	Shim;Nuts/Mutter ,U-Scheibe/Ecrou;Rondelle 8 mm For fixing storm braces/ Pour fixer les anti tempete/ Für Sturmleisten Pour fixer les croisillons des fenetres et des portes  Metal storm Brace/Gewindestange/Tige filetee 8 mm KL1 M8 2,18 m 2 Screws 180 10 pcs. KL2 M8 2,12 m 1 Plastic caps 5 pcs. KL3 M8 2,46 m 2	5/5		

Teileliste 3 846070

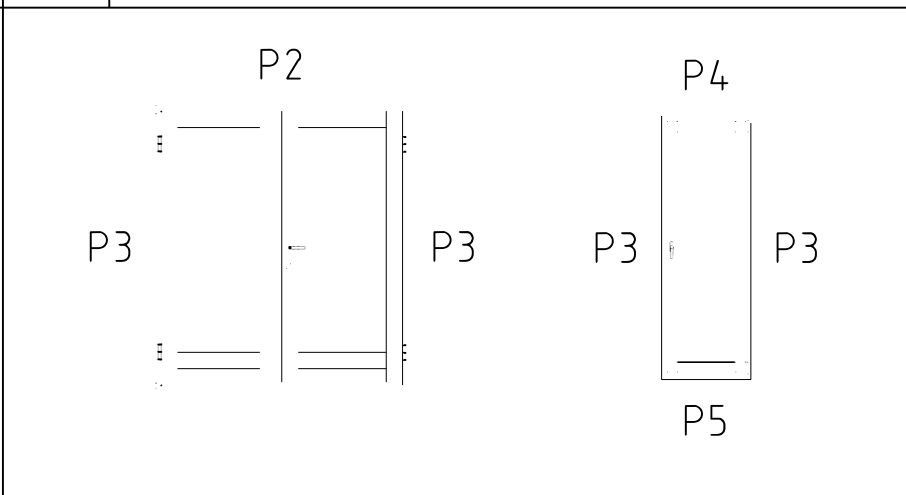
POS	ST.	B	H	L	Teileliste
FB1	Vt. spetsi				FUNDMENTHOLZER
F1	19,2m ²	28		3905	FUSSBODENBRETTER
PR	3	70	170	5400	DACHBALKEN
RB1	26,6m ²	20		4919	DACHBRETTER
*R1	2	20	140	5440	Traufenbretter
*R2	2	45	45	5400	Traufenbretter
*R3	2	20	140	5120	Giebelabschlussleiste
*R4	2	20	90	5120	Giebelabschlussleiste
DR1 WN1	1 2	1588 600	1965 1770		
*P1	19m	20	40		Fußbodenleiste
*P2	1+1	20	90	1890	Türleiste DR1
*P3	6+6	20	90	1945	Türleiste DR1, Fensterleiste WN1
*P4	2+2	20	90	900	Fensterleiste WN1
*P5	2+2	20	90	540 570	Fensterleiste WN1

*Wird als Fixlänge geliefert und muss bauseits zugeschnitten werden.

Wandplan 1 und 2 846070

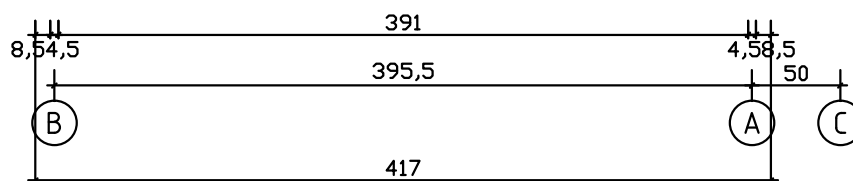
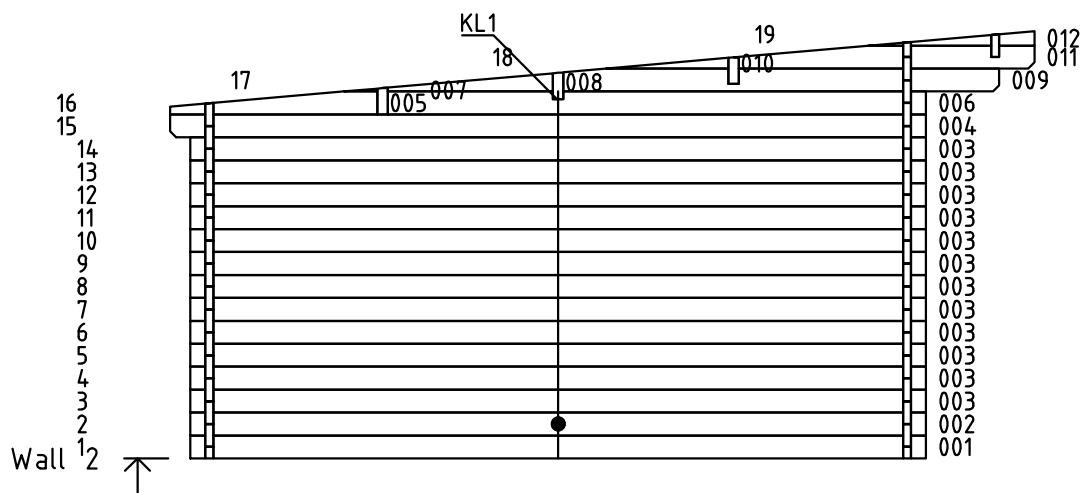
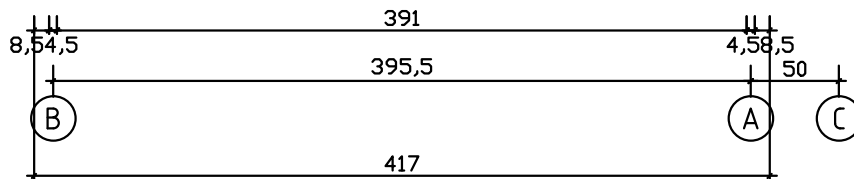
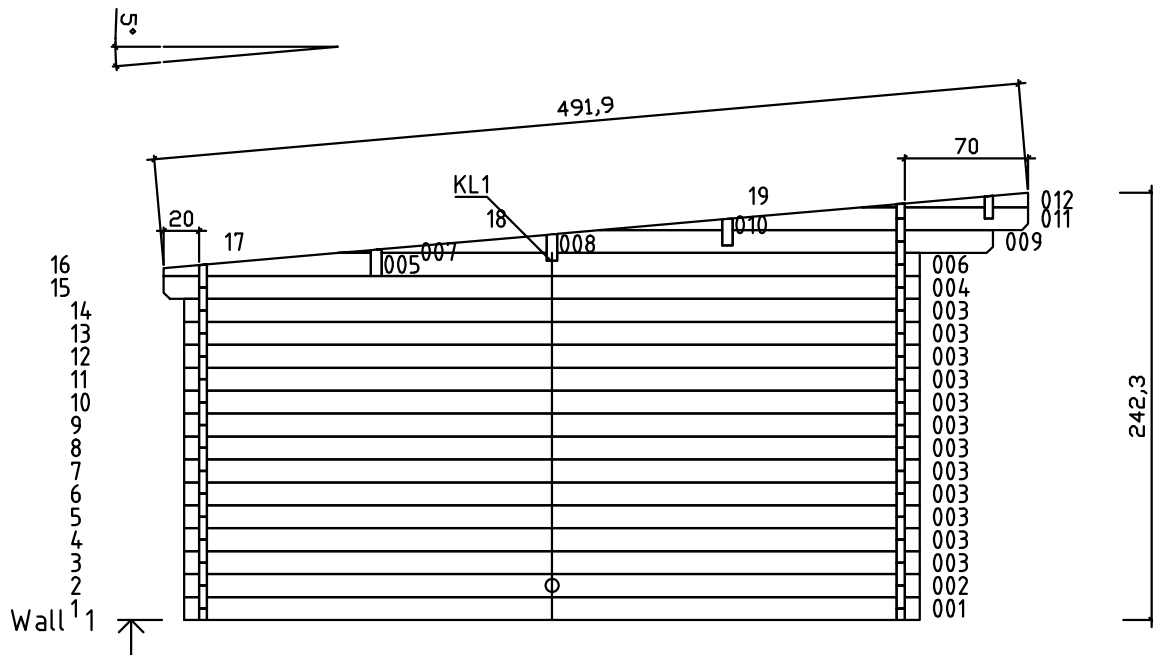

Wandplan A und B 846070

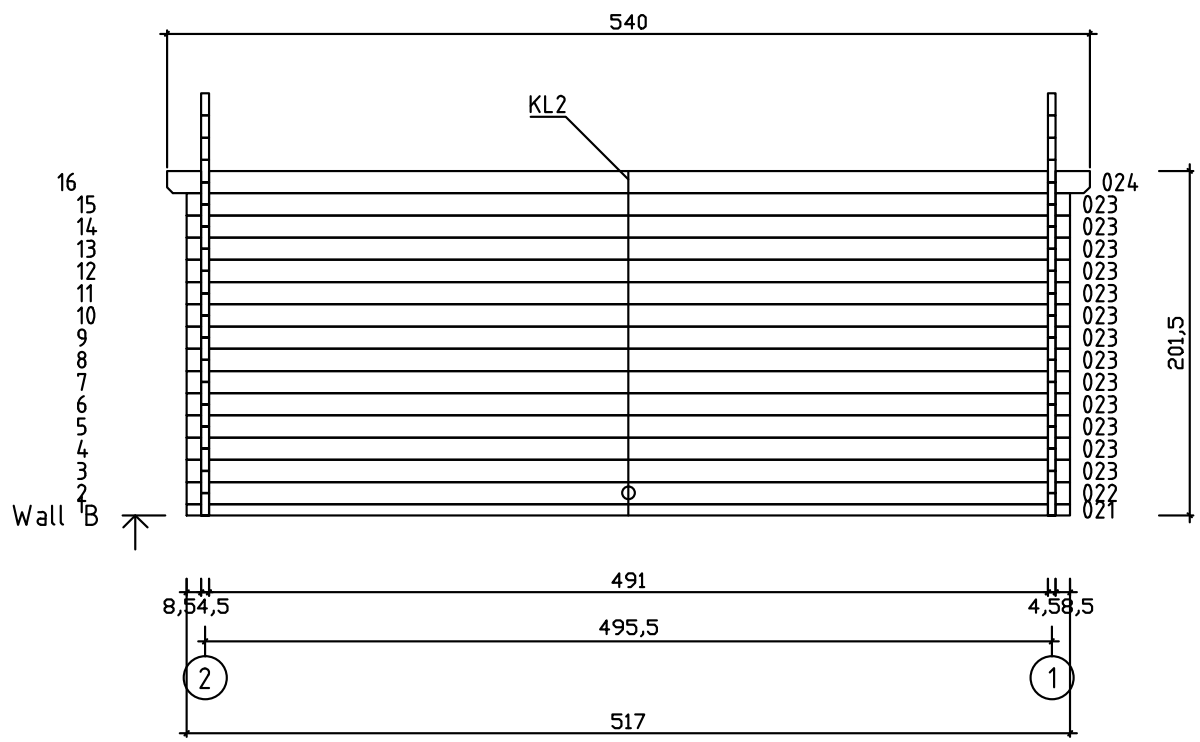
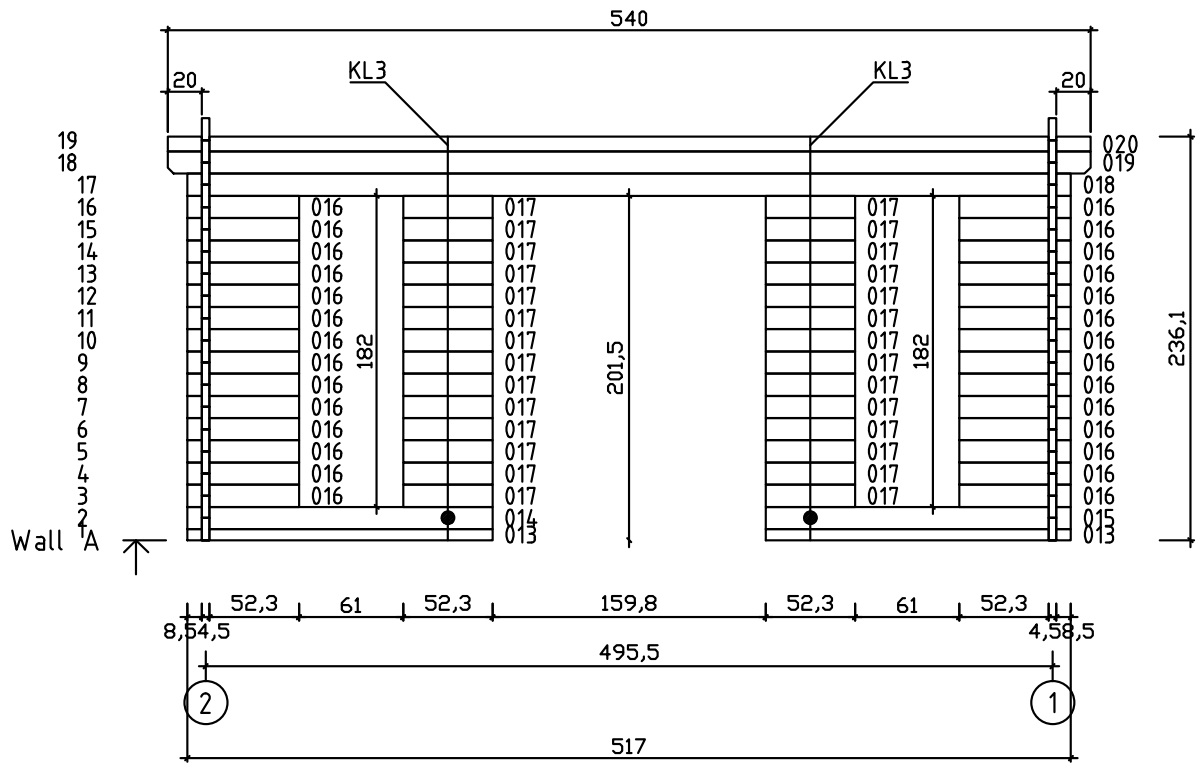

Wandplan C 846070

Vorgelagerte Vordachbohle vor Wand A

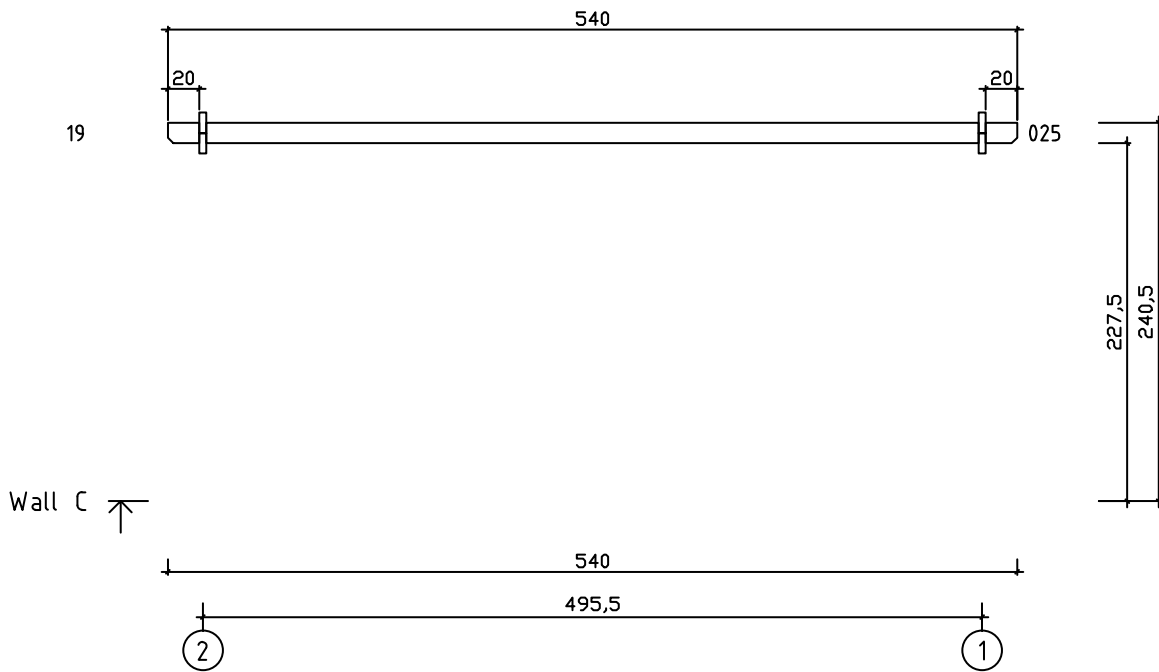

Details 846070

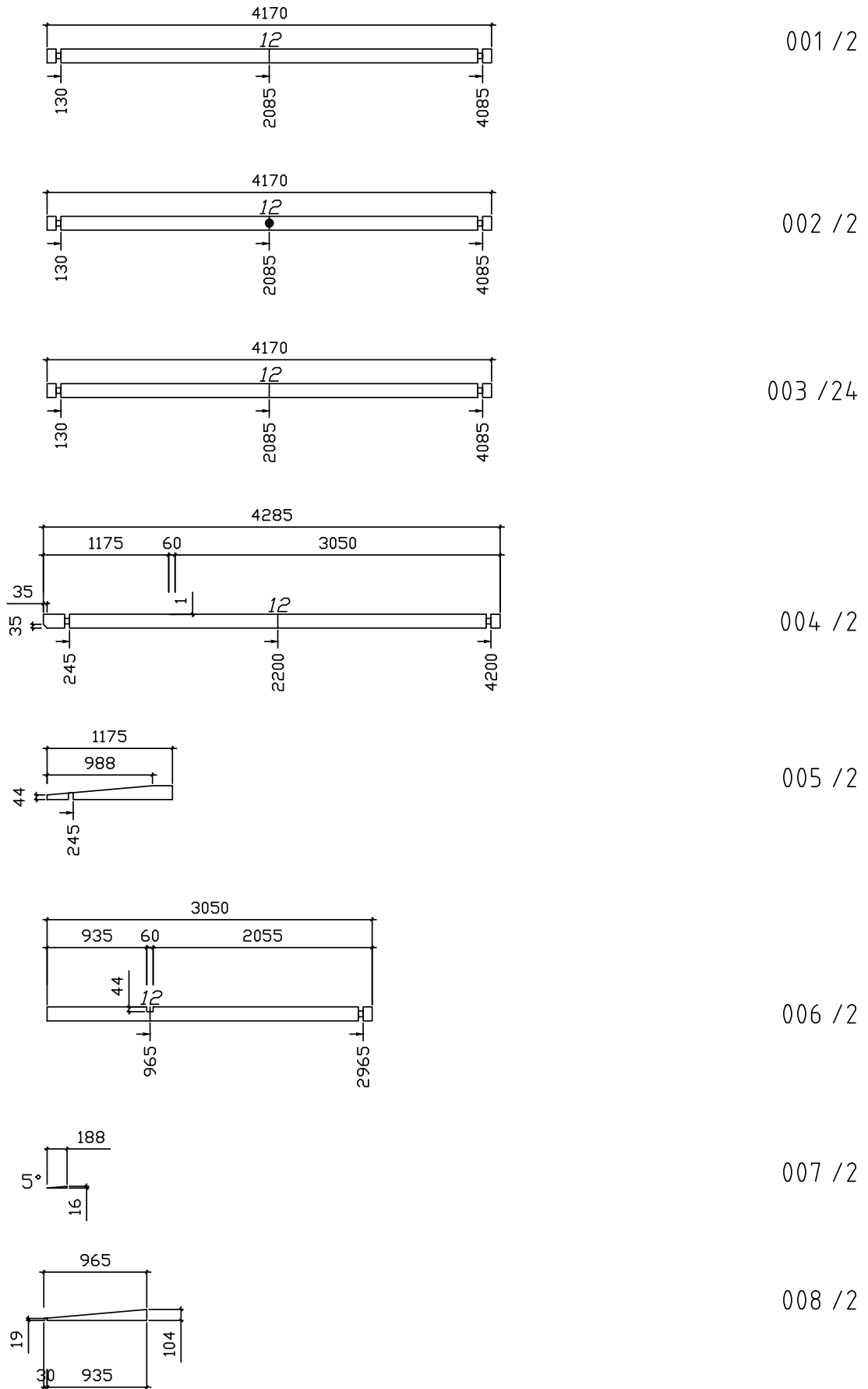

Details 846070

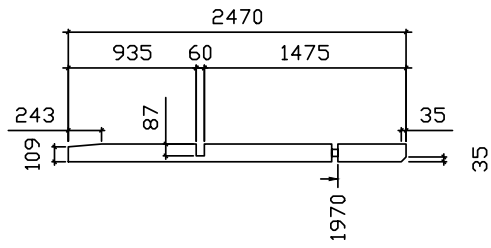

009 / 2

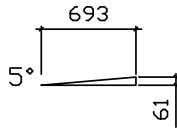

010 / 2

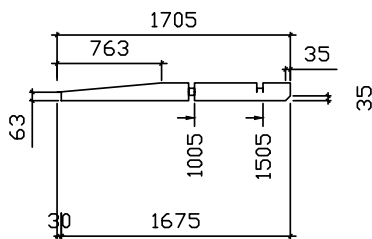

011 / 2

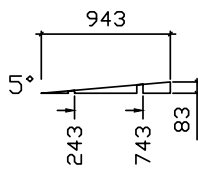

012 / 2

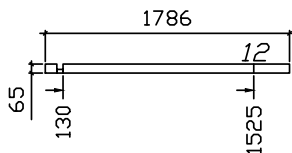

013 / 2

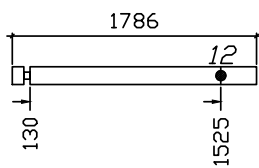

014 / 1

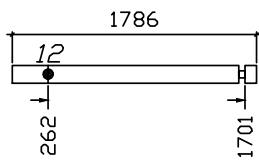

015 / 1

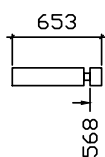

016 / 28

Details 846070

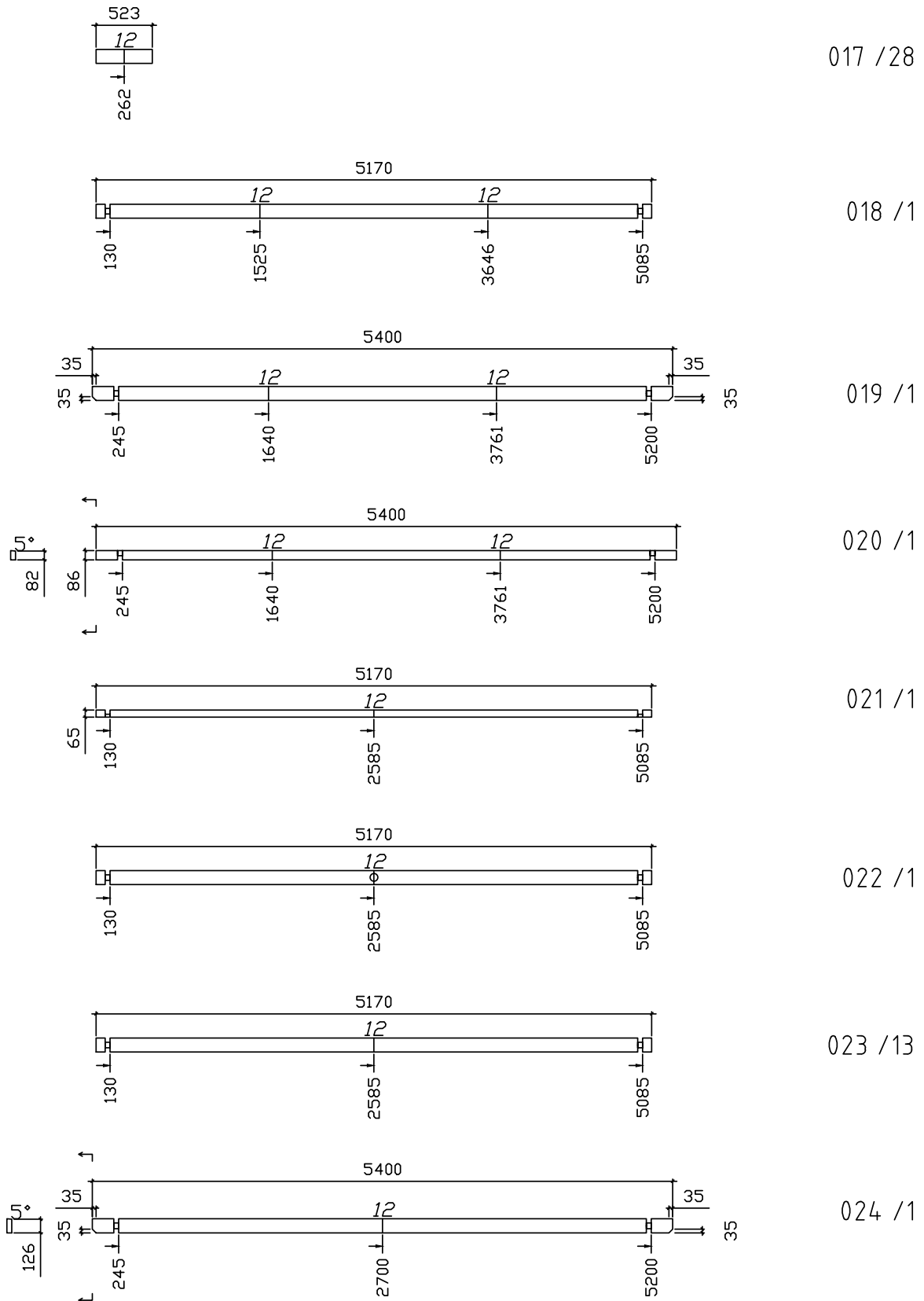

Details 846070

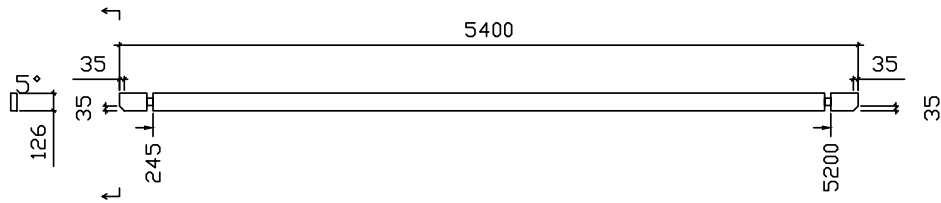

025 / 1

Rahmen-Fundementholz

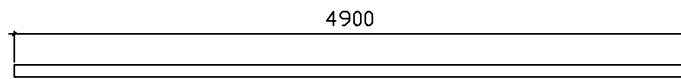

GR1 / 4
45x90

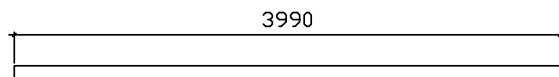

GR2 / 2
45x90

Fundementholz

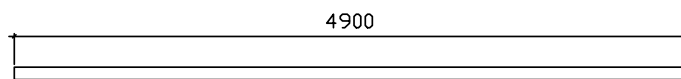

FB1 / 6
45x90

Pfetten

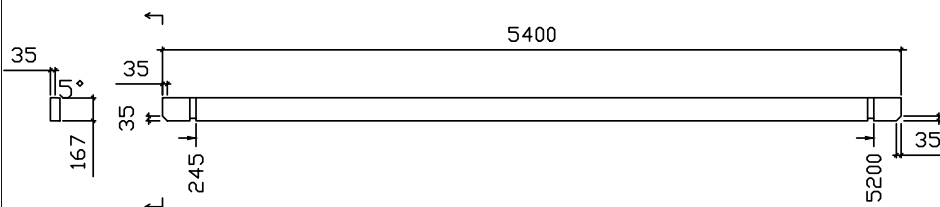

PR1 / 3
70x170(60x150)