

Technische Daten: Art.-Nr.: 846010

Wandaußenmaß: 360 x 360 cm

Bohlenstärke: 44 mm



Trondheim 70-D XL

Kontrolliert durch:

Achtung: Alle angegebenen Maße sind ca.-Maße!

3D-Darstellung und Grundriss 846010

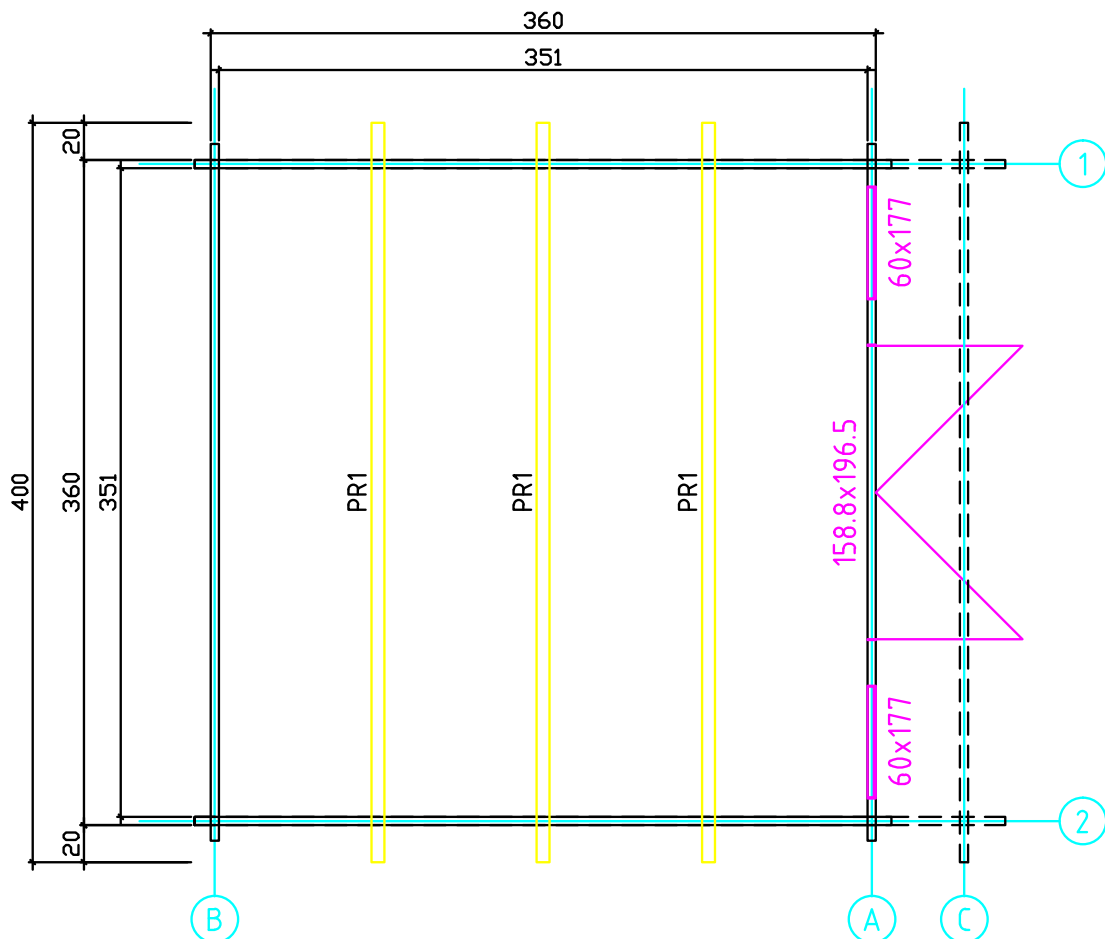
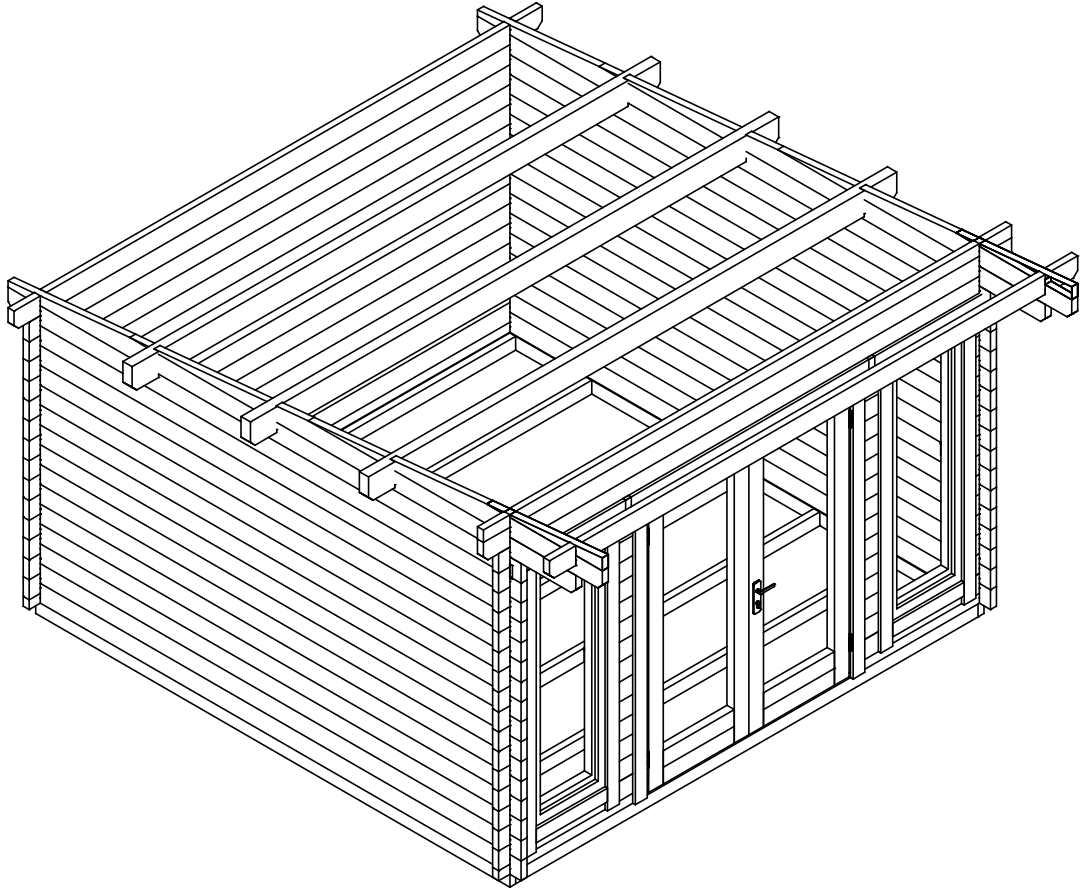





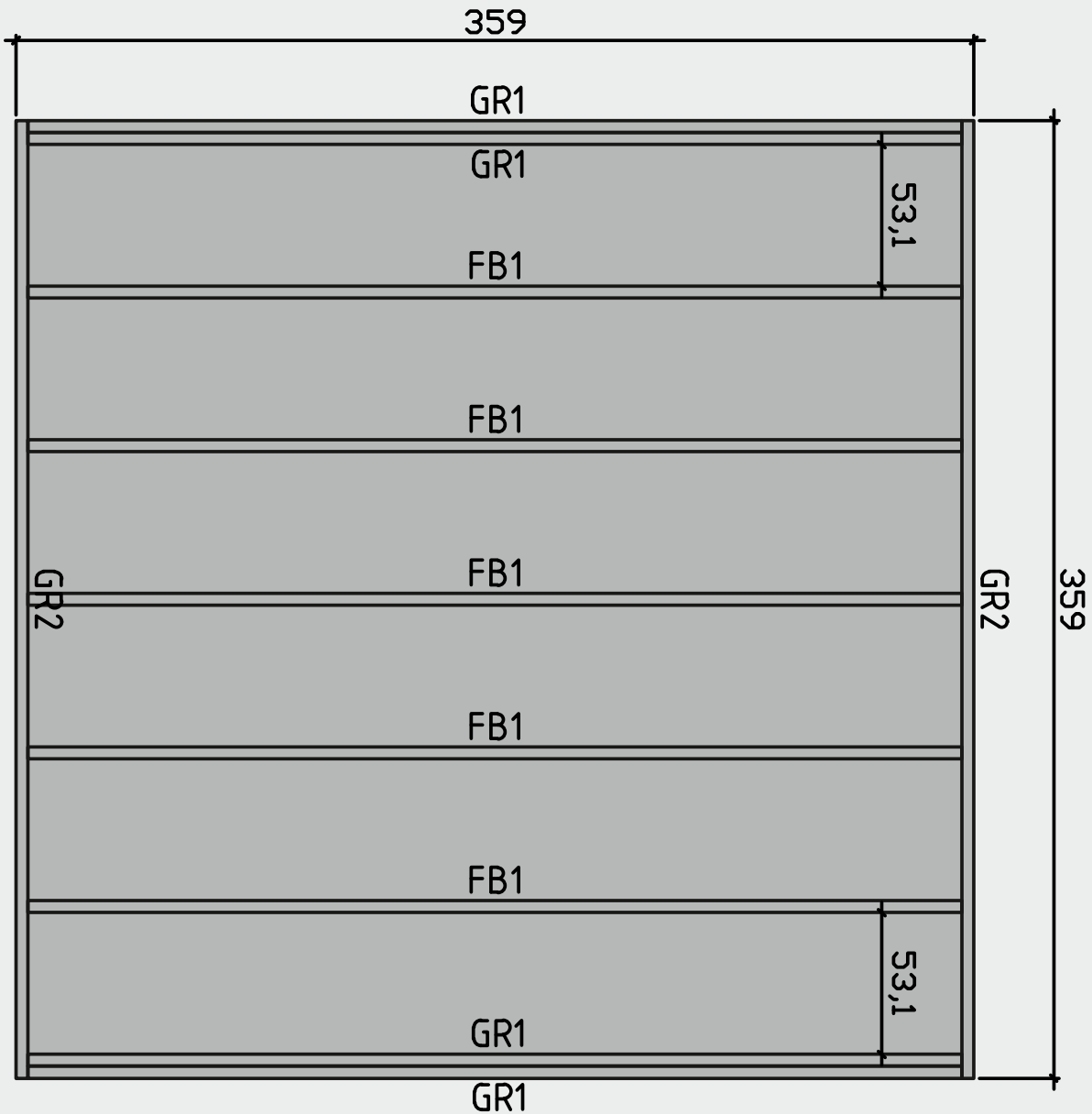

Lagerholzplan und Fundamentplan 846010

Wir empfehlen als Fundament für Ihr Gartenhaus eine vollflächig festgegründete, gepflasterte oder betonierte Fläche.
Wahlweise ist auch ein Punkt- oder Streifenfundament möglich.

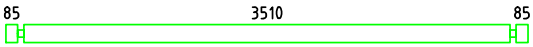
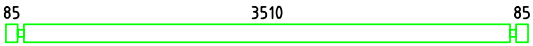
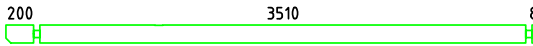
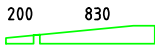
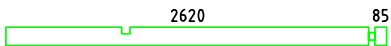

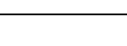
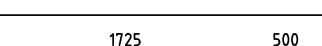
Teileliste 1

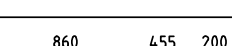
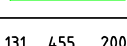
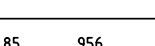
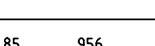
846010

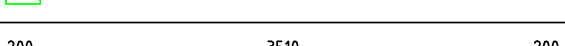
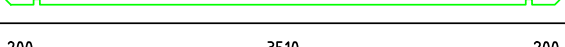
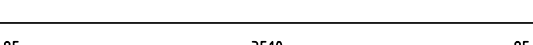
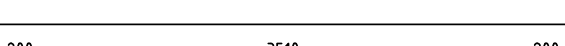
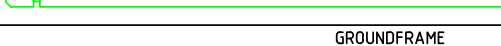
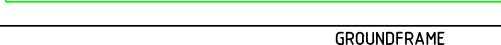
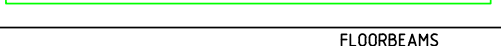
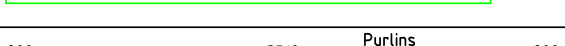
Pos		Quantity	Profil (mm)	Lenght (mm)
001		2	45x130	3770
002		41	45x130	3770
003		2	45x130	3885
004		2	45x130	1075
005		2	45x130	2750
006		2	45x15	154
007		2	45x101	865
008		2	45x130	2270
009		2	45x57	592
010		2	45x130	1605
011		2	45x84	876
012		2	45x65	1086
013		2	45x130	1086
014		28	45x130	230
015		28	45x130	246
016		1	45x130	4000
017		1	45x82	4000
018		1	45x65	3770
019		2	45x130	4000
GR2	GROUNDFRAME 	2	45x90	3590
GR1	GROUNDFRAME 	4	45x90	3500
FB1	FLOORBEAMS 	5	45x90	3500
PR1	Purlins 	3	70x170	4000
	WINDOW 600x1770	2		
	DOOR 1588x1965	1		

Teileliste 3

846010

POS	ST.	B	H	L	Teileliste
FB1	Vt. spetsi				FUNDMENTHOLZER
F1	12,3m ²	28		3505	FUSSBODENBRETTER
PR	3	70	170	4000	DACHBALKEN
RB1	18,1m ²	20		4521	DACHBRETTER
*R1	2	20	140	4040	Vaata katuse kalonenurka Traufenbretter
*R2	2	45	45	4000	Vaata katuse kalonenurka Traufenbretter
*R3	2	20	140	4720	Vaata katuse kalonenurka Giebelabschlussleiste
*R4	2	20	90	4720	Giebelabschlussleiste
DR1 WN1	1 2	1588 600	1965 1770		
*P1	15m	20	40		Fußbodenleiste
*P2	1+1	20	90	3500	Türleiste DR1, Fensterleiste WN1
*P3	6+6	20	90	1945	Türleiste DR1, Fensterleiste WN1
*P4	2+2	20	90	540 570	Fensterleiste WN1

*Wird als Fixlänge geliefert und muss bauseits zugeschnitten werden.

Wandplan 1 und 2 846010

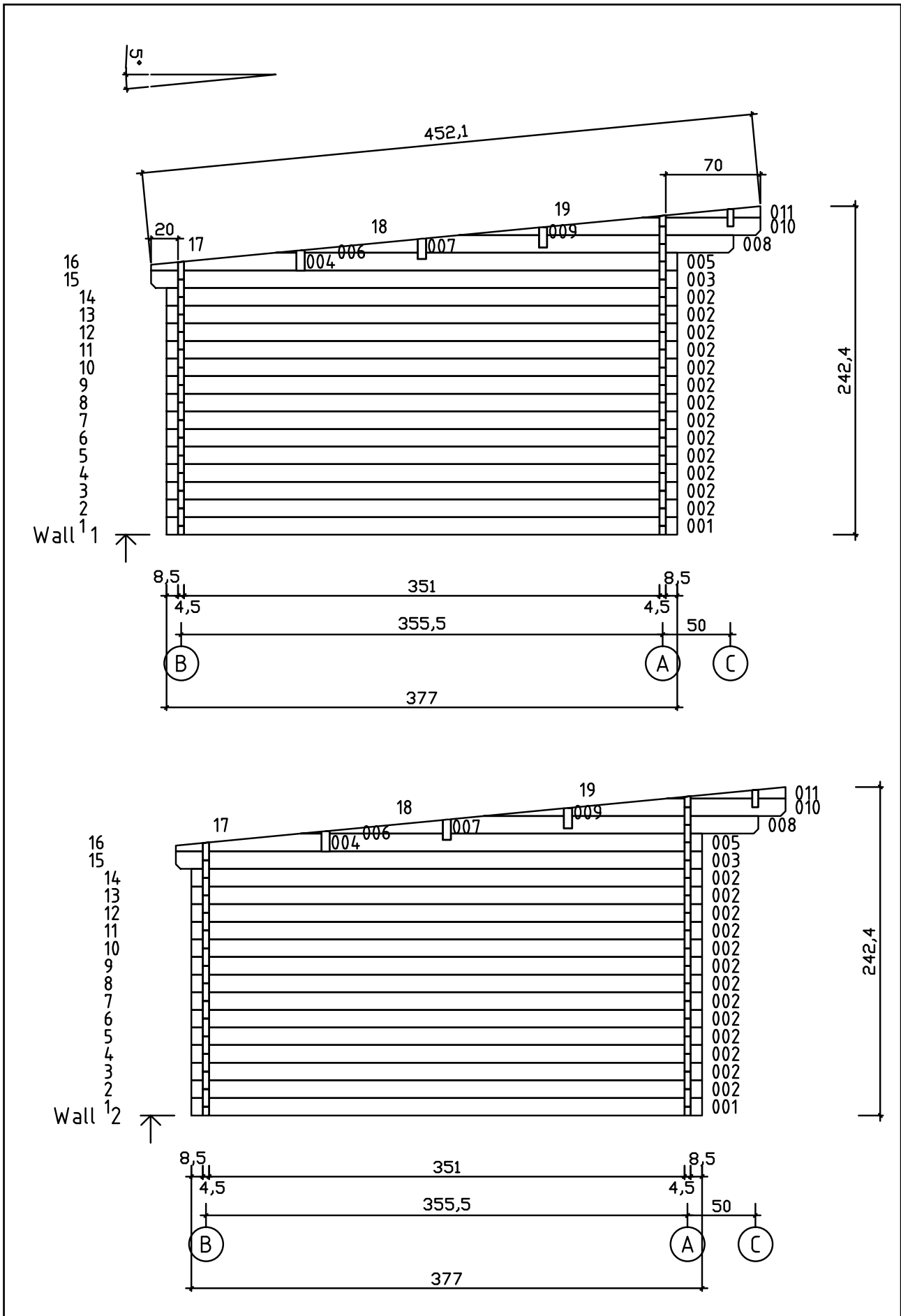

Wandplan A und B 846010

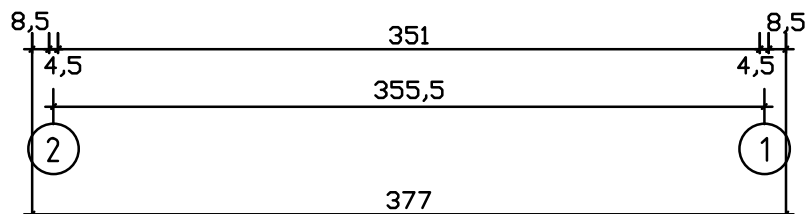
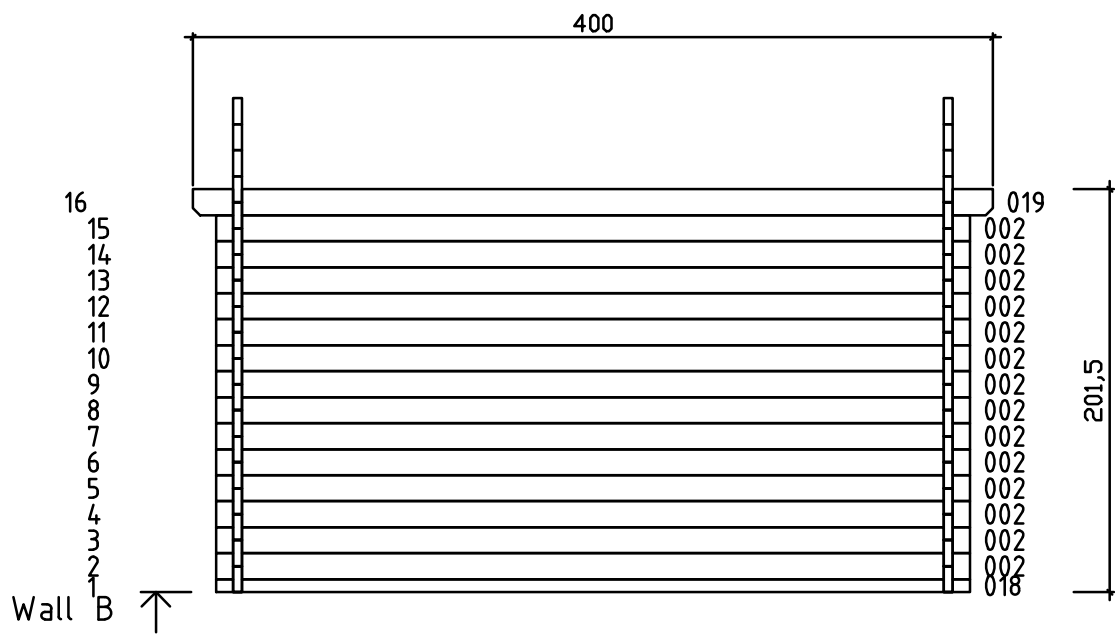
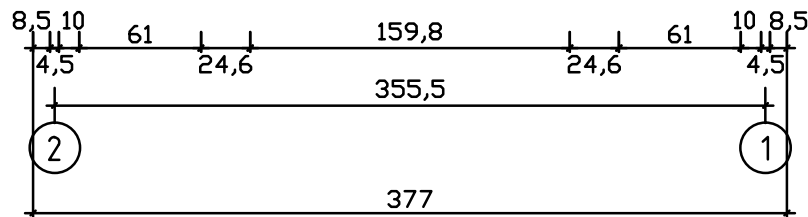
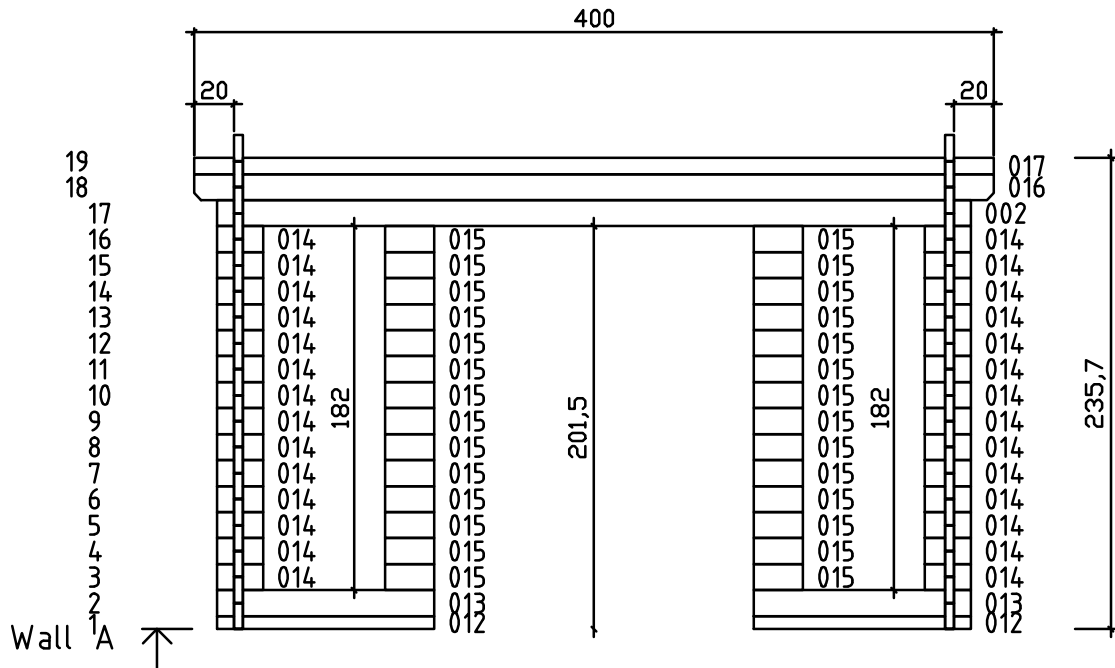

Wandplan C 846010

Vorgelagerte Vordachbohle vor Wand A

