

Technische Daten: Art.-Nr.: 845160

Wandaußenmaß: 450 x 330 cm

Bohlenstärke: 44 mm



Cordoba 44-A Klassik

Kontrolliert durch:

Achtung: Alle angegebenen Maße sind ca.-Maße!

Korpus für 845160



Cordoba 44-A Klassik

Kontrolliert durch:

Achtung: Alle angegebenen Maße sind ca.-Maße!

3D-Darstellung und Grundriss Korpus für 845160

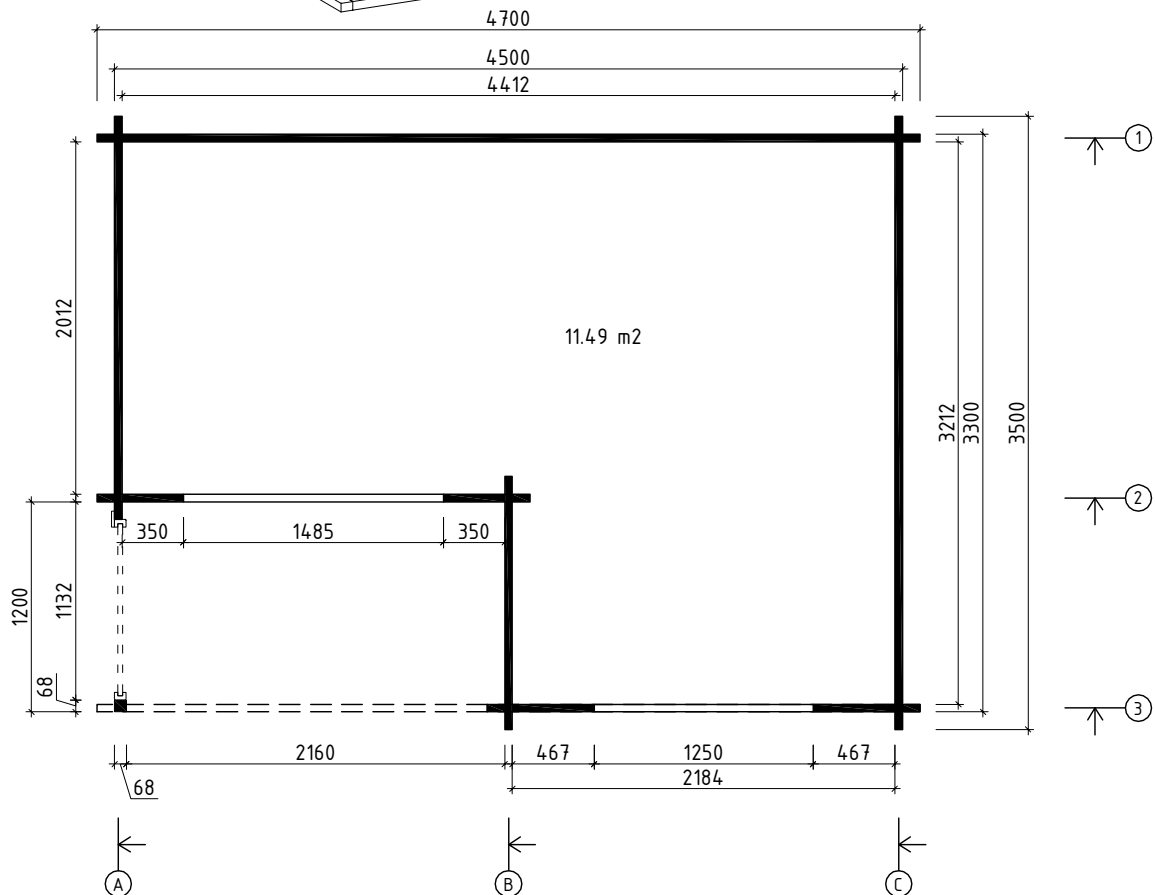
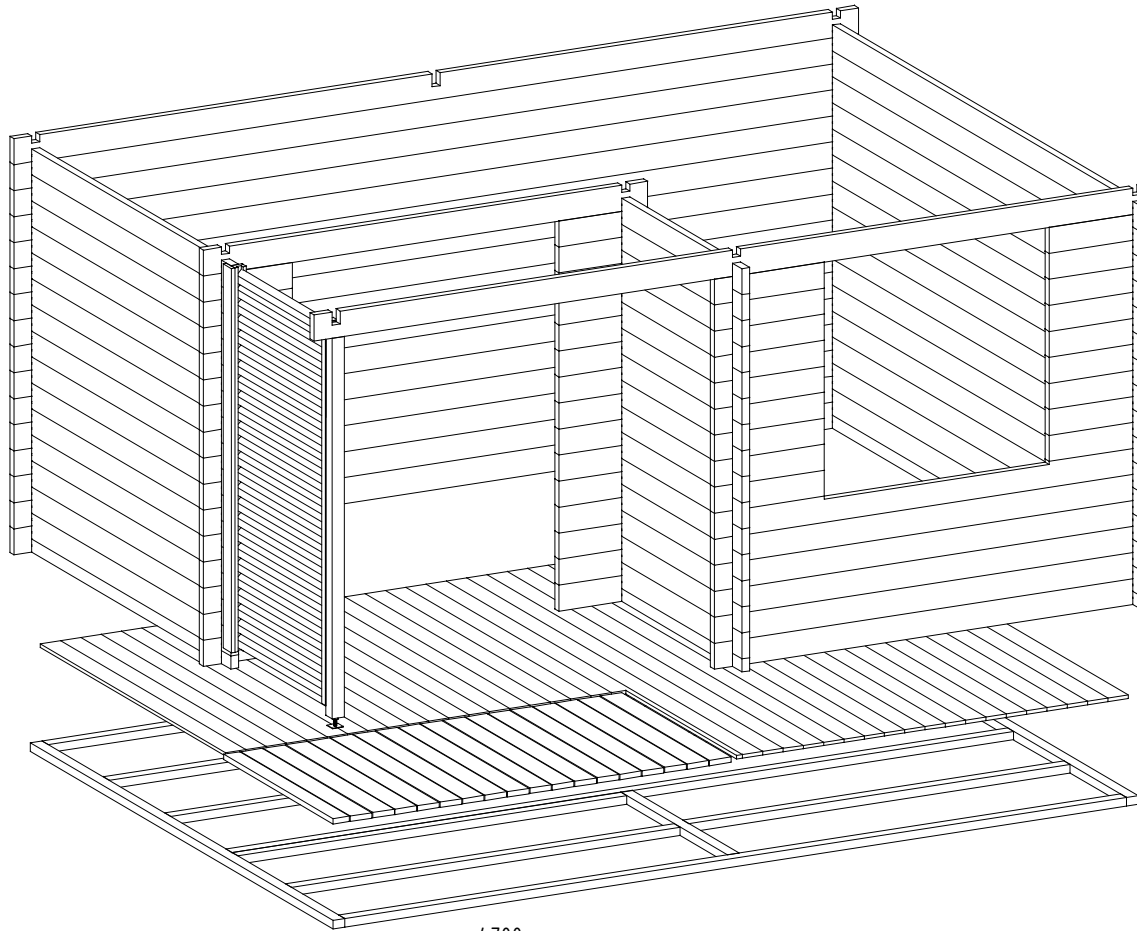





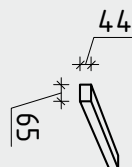
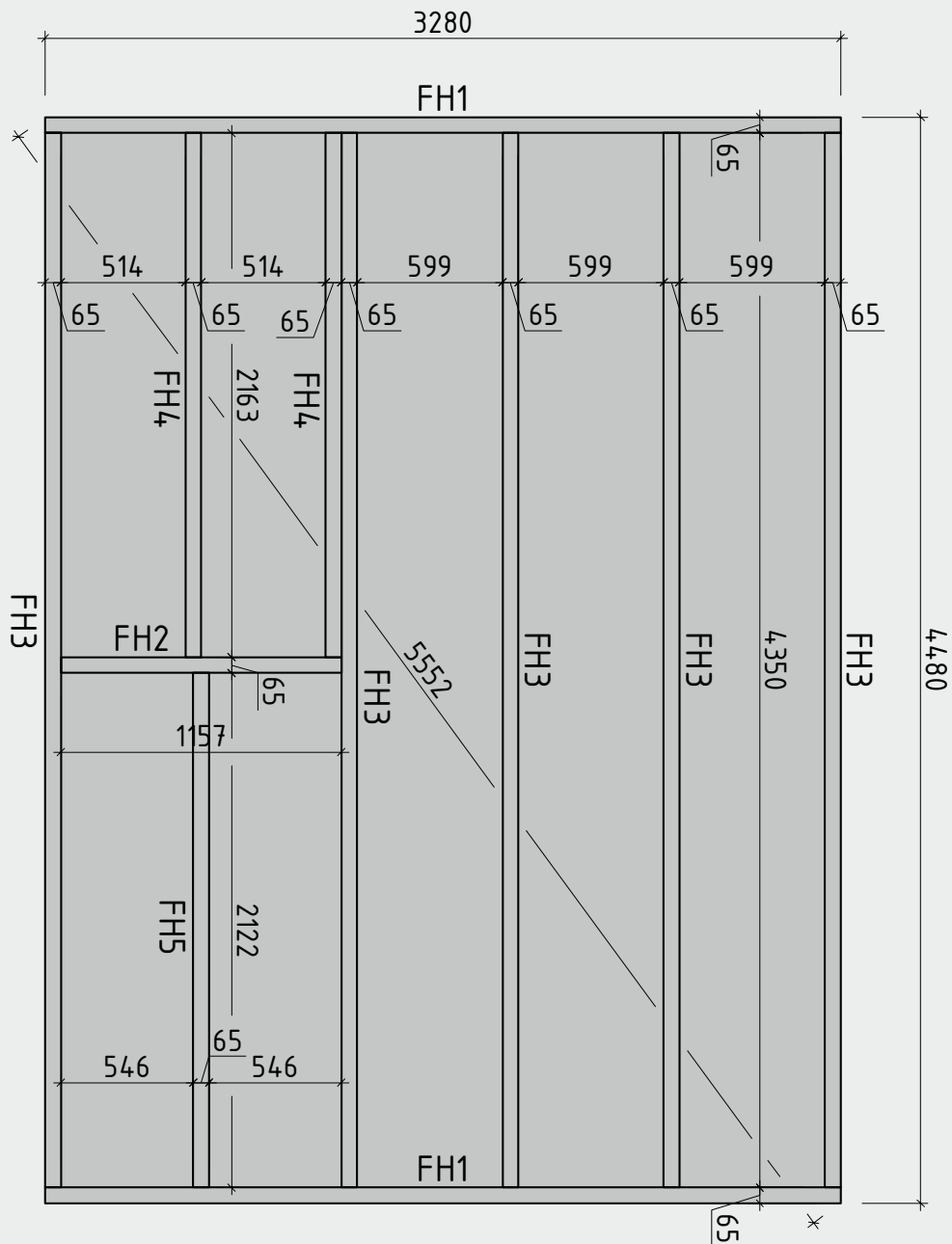





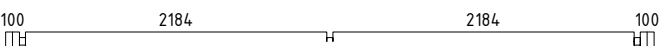
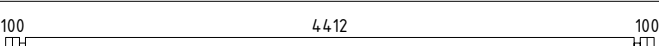

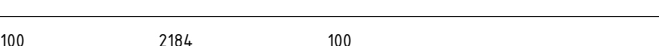
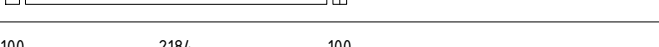
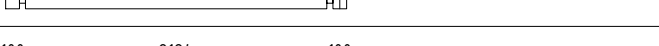

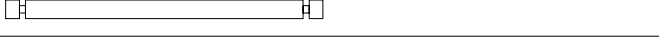
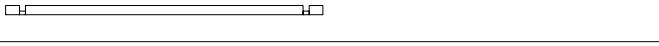

Lagerholzplan und Fundamentplan Korpus für 845160

Wir empfehlen als Fundament für Ihr Gartenhaus eine vollflächig, festgegründete gepflasterte oder betonierte Fläche.
Wahlweise ist auch ein Punkt- oder Streifenfundament möglich.

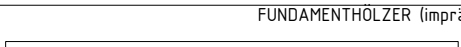

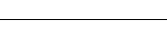

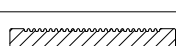







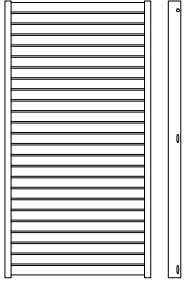

Teileliste 1

Korpus für 845160

Pos		Stck	Profil (mm)	Länge (mm)
001		1	44x135	4700
002		1	44x135	4700
003		15	44x135	4700
004		15	44x135	3500
005		1	44x68	3500
006		1	44x135	2472
007		5	44x135	2472
008		1	44x135	2472
009		15	44x135	2300
010		1	44x68	2300
011		15	44x135	1444
012		1	44x68	1444
013		9	44x135	611
014		9	44x135	611
015		30	44x135	493
FH3	FUNDAMENTHÖLZER (imprägniert) 	5	65x44	4350
FH1	FUNDAMENTHÖLZER (imprägniert) 	2	65x44	3280
FH4	FUNDAMENTHÖLZER (imprägniert) 	2	65x44	2163
FH5	FUNDAMENTHÖLZER (imprägniert) 	1	65x44	2122
FH2	FUNDAMENTHÖLZER (imprägniert) 	1	65x44	1157
	FUSSBODENBRETTER 	20+1	113x18	3205
	FUSSBODENBRETTER 	19	113x18	2005
	TERRASSENBRETTER (imprägniert) 	18+1	120x28	1190
	FUSSBODENLEISTE  ✓		18x40	16,0 lfm
SP1-1	STÜTZPFOSTEN 68x68  ✓	1	68x68	2095

Teileliste 2

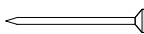
Korpus für 845160

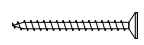
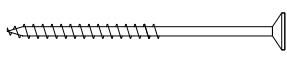
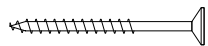
Pos			Stck.	Profil (mm)	Länge (mm)
	GITTERWAND ELEMENT		1	105x1994	
SH	Schlaghölzer		3		
SS02	Schlossschrauben M8x70 Mutter U-Scheibe (für Gitterwand)		3	M8	
VP1	Verstellbare Pfostenstütze M10		1	M10	
KL1	Gewindestange M8		3	M8	2000
KL2	Gewindestange M8		✓ 1	M8	460
KL3	Gewindestange M8		✓ 2	M8	325
KL4	Gewindestange M8		✓ 1	M8	430
	Mutter M8 U-Scheibe Ø25		8	M8	
	Befestigungsmutter M8		3	M8	
NG1	NÄGEL 2.5x50 Dachbretter Fussbodenbretter		390		
NG2	NÄGEL 2.5x60 Terrassenbretter		108		
SR01	SCHRAUBEN 3.0x30 Fussbodenleisten		30		
SR03	SCHRAUBEN 3.5x45 Gitterwand		6		
SR11	SCHRAUBEN 5.0x100 Fundamenthölzer		28		
SR10	SCHRAUBEN 5.0x70 Gitterwand		4		
	✓ - bitte selber anpassen (falls nötig)!				

Teileliste 3

Korpus für 845160

Montageanleitung für Gitterwand

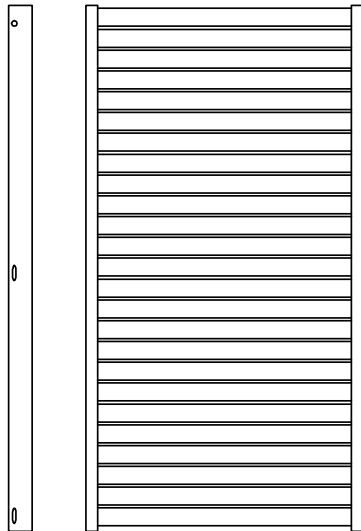

Schrauben 3.5*45mm

6 Stck.



Schrauben 5x70mm

4 Stck.

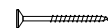

Schlossschrauben M8x70
Mutter U-Scheibe

3 Stck.

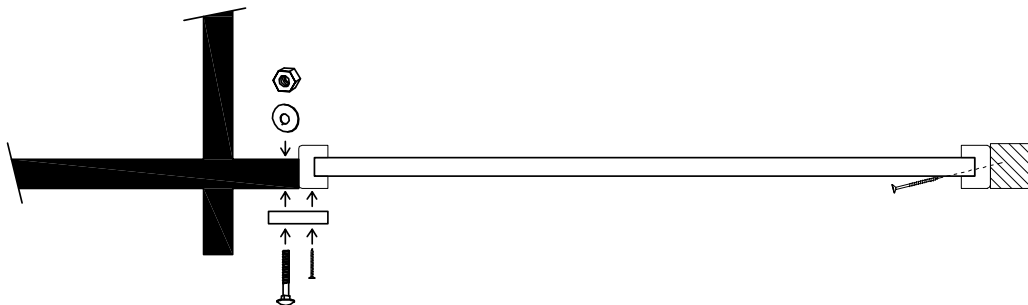
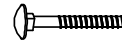

Spiegelverkehrt



Wandplan 1 und 2 Korpus für 845160

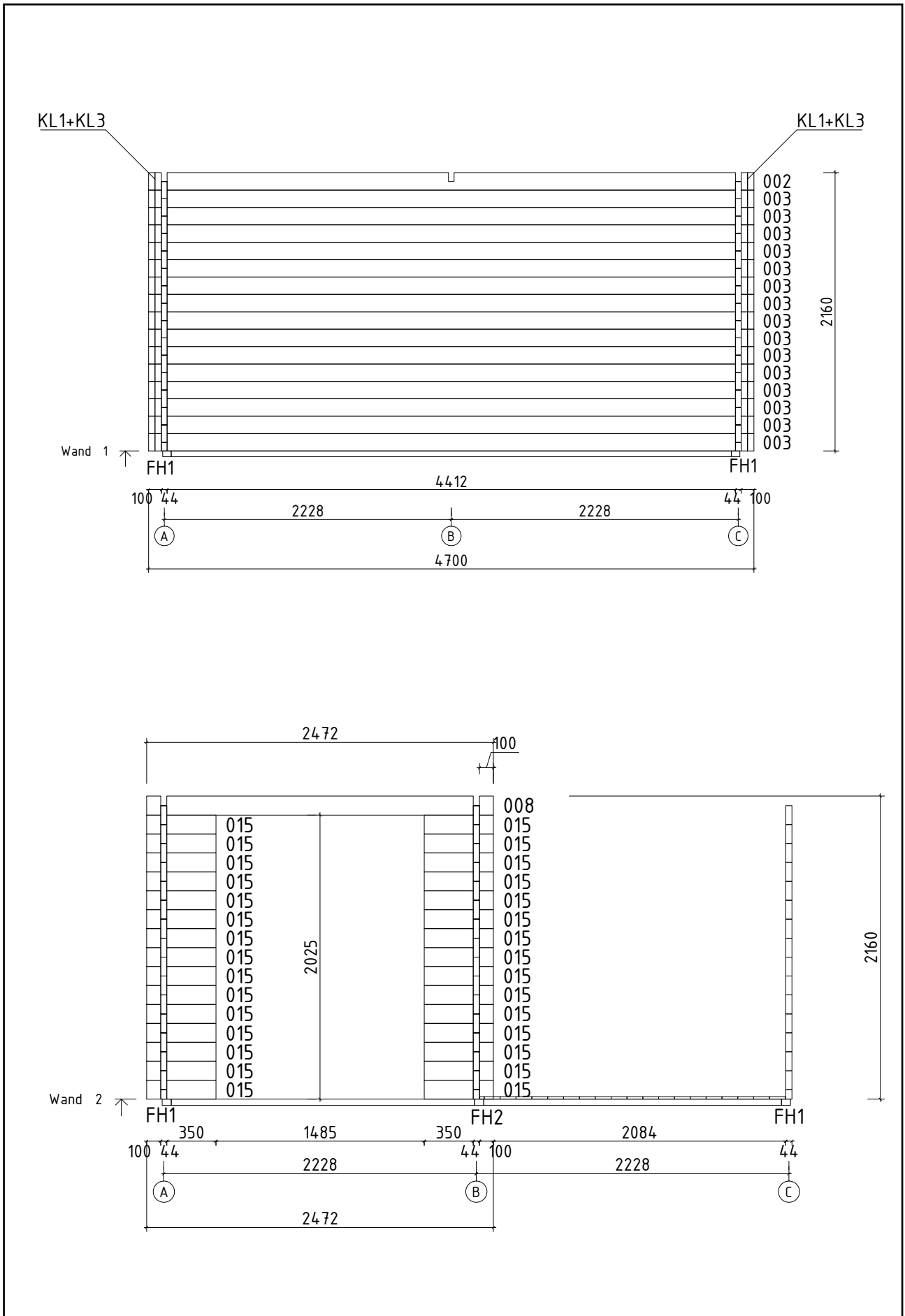

Wandplan 3 Korpus für 845160

Cordoba 44-A Klassik

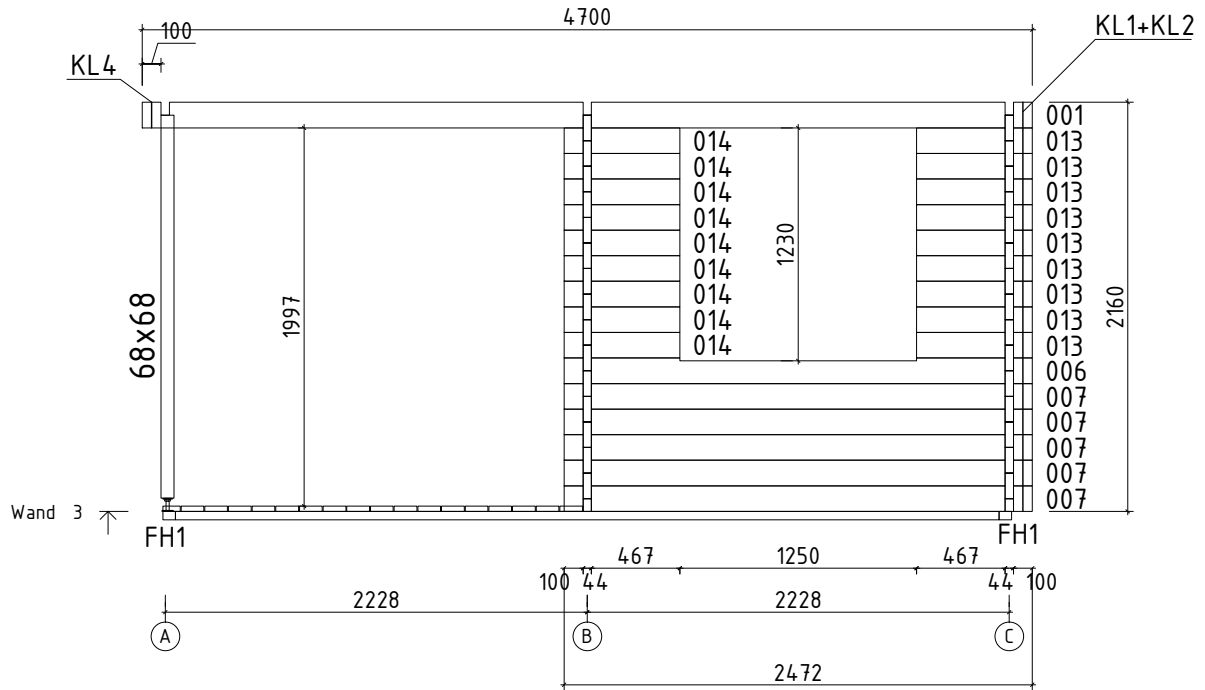

Wandplan A und B

Korpus für 845160

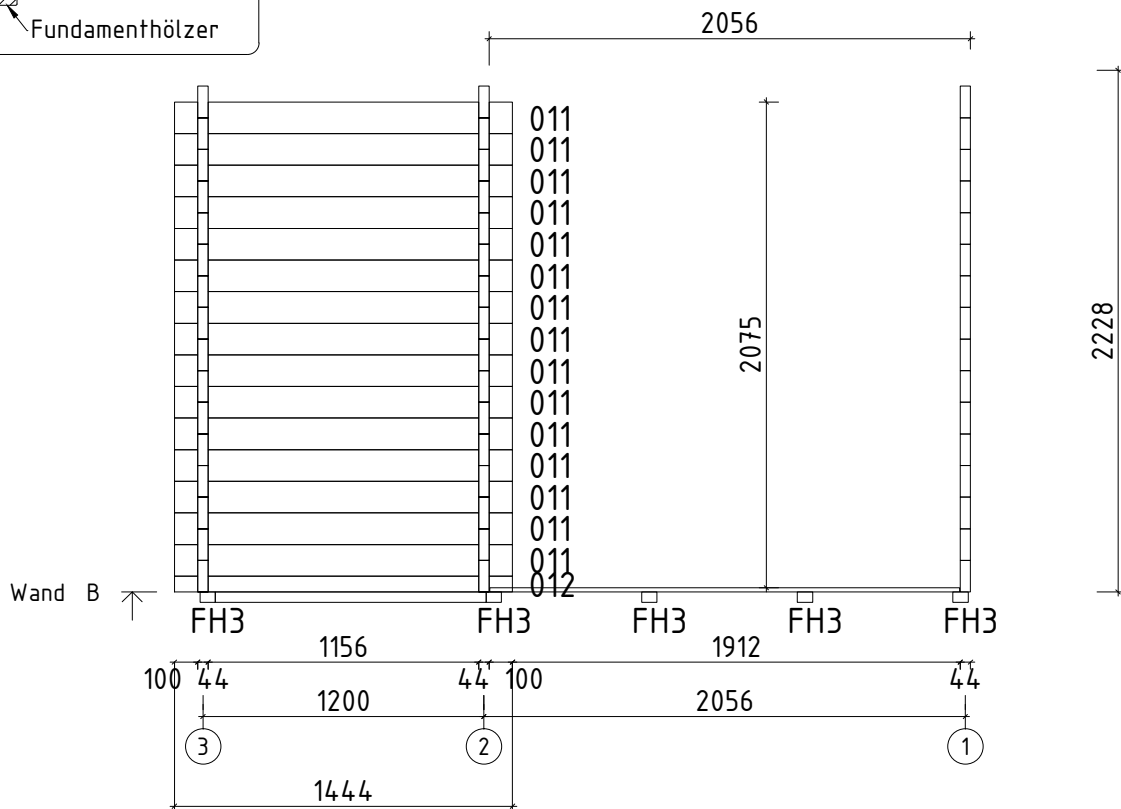
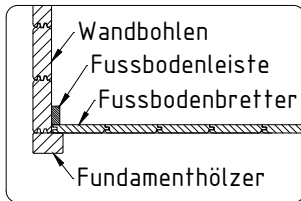
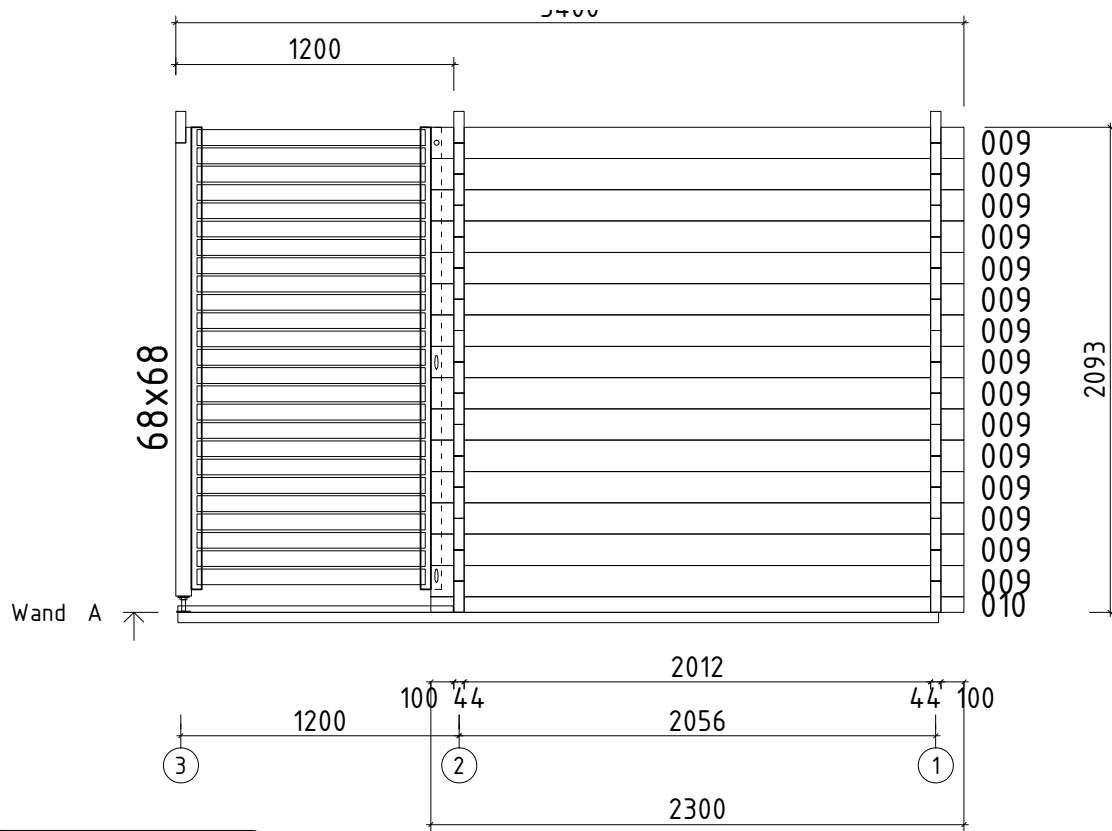

Wandplan C

Korpus für 845160

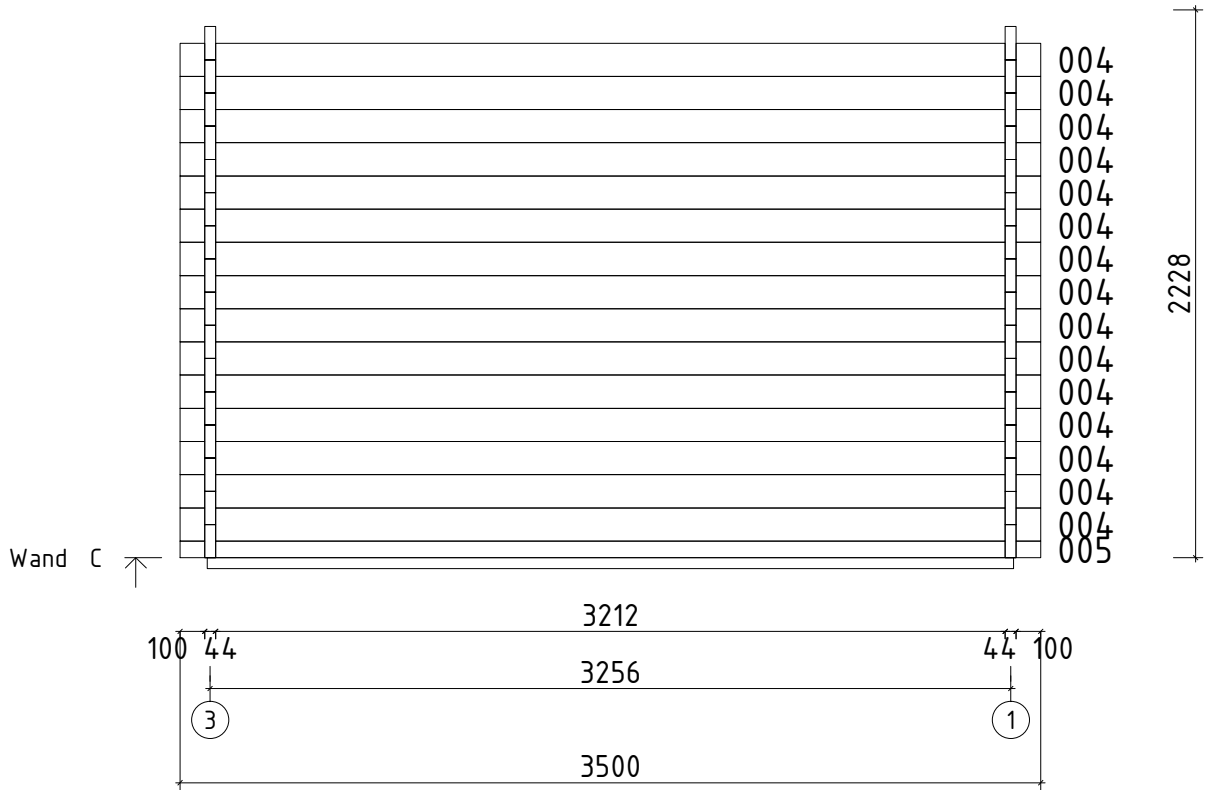

Flachdach für 845160



Cordoba 44-A Klassik

Kontrolliert durch:

Achtung: Alle angegebenen Maße sind ca.-Maße!

3D-Darstellung und Grundriss Flachdach für 845160

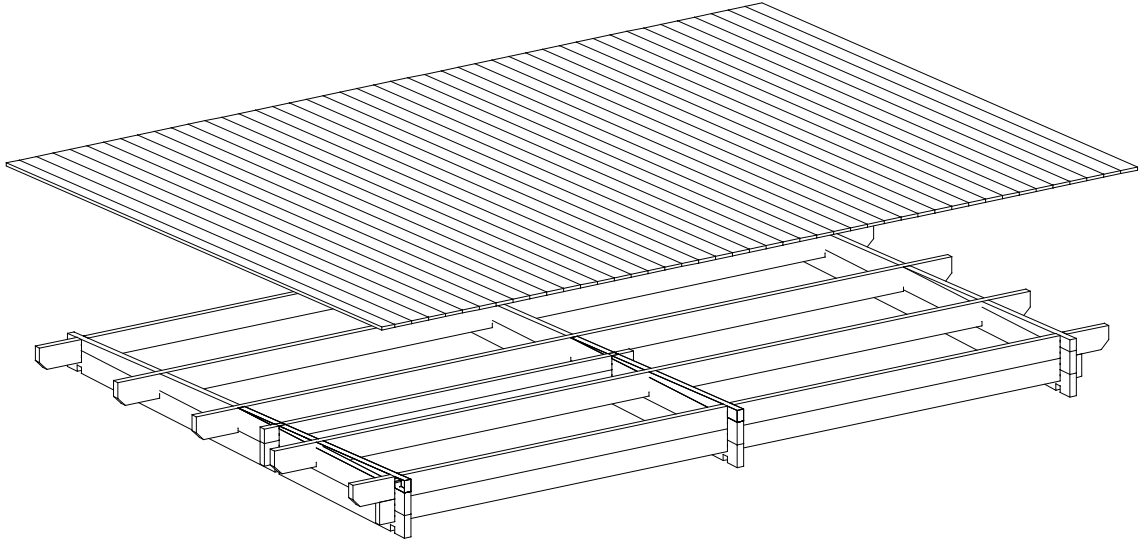

Teileliste 1

Flachdach für 845160

Pos		Stck.	Profil (mm)	Länge (mm)
001		2	44x133	5060
002		1	44x135	4700
003		1	44x135	3500
004		2	44x135	3500
005		1	44x135	3500
006		2	44x135	3500
007		1	44x83	2472
008		1	44x135	2472
009		2	44x72	1728
010		1	44x72	1728
DB1		3	44x145	5060
	DACHBRETTER	45+1	113x18	3905
G1-1	GIEBELBRETTER 120X18	2	120x18	3925
G6-1	GIEBELDECKLEISTE 40X18	✓ 2	40x18	3923
T1-1	TRAUFBRETTER 120X18	1	120x18	5096
T2-1	TRAUFBRETTER 90X18	1	90x18	5060
T4-1	TRAUFENLEISTE 40x18	✓	40x18	11,0 lfm
T6-1	TRAUFENDECKLEISTE 40x18	2	40x18	2548
SH	Schlaghölzer	3		
NG3	DACHPAPPNÄGEL 2.0x18	400		
NG1	NÄGEL 2.5x50 Dachbretter	450		
SR01	SCHRAUBEN 3.0x30 Giebeldeckleisten Traufenleisten, Traufendeckleisten	51		
SR03	SCHRAUBEN 3.5x45 Giebelbretter, Traufenbretter	40		
	DACHPAPPE	✓	5,1m-5st.	26,0 lfm
	✓ - bitte selber anpassen (falls nötig!)			

Wandplan 1 und 2 Flachdach für 845160

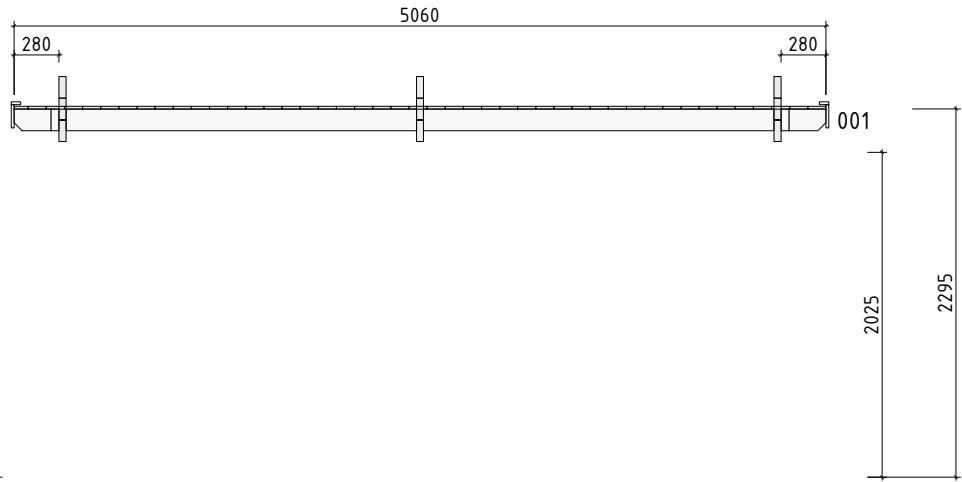
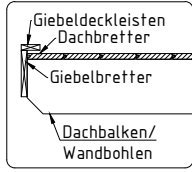

Wand 1 ↗

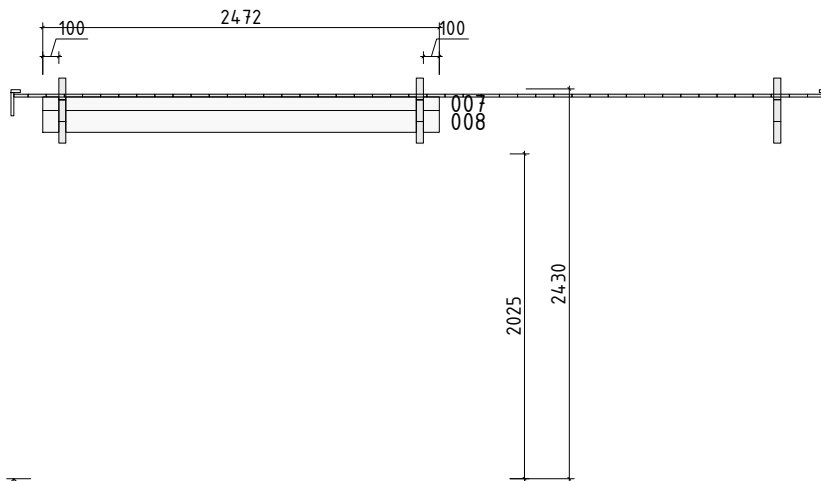
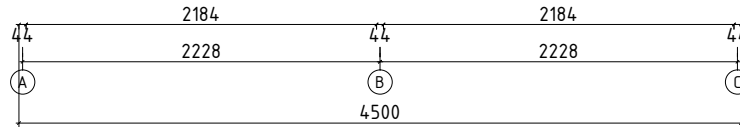

Wand 2 ↘

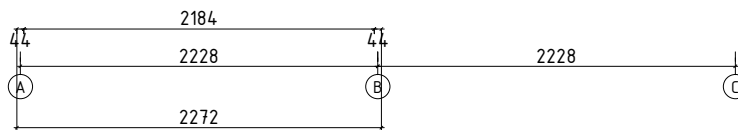

Wandplan 3

Flachdach für 845160

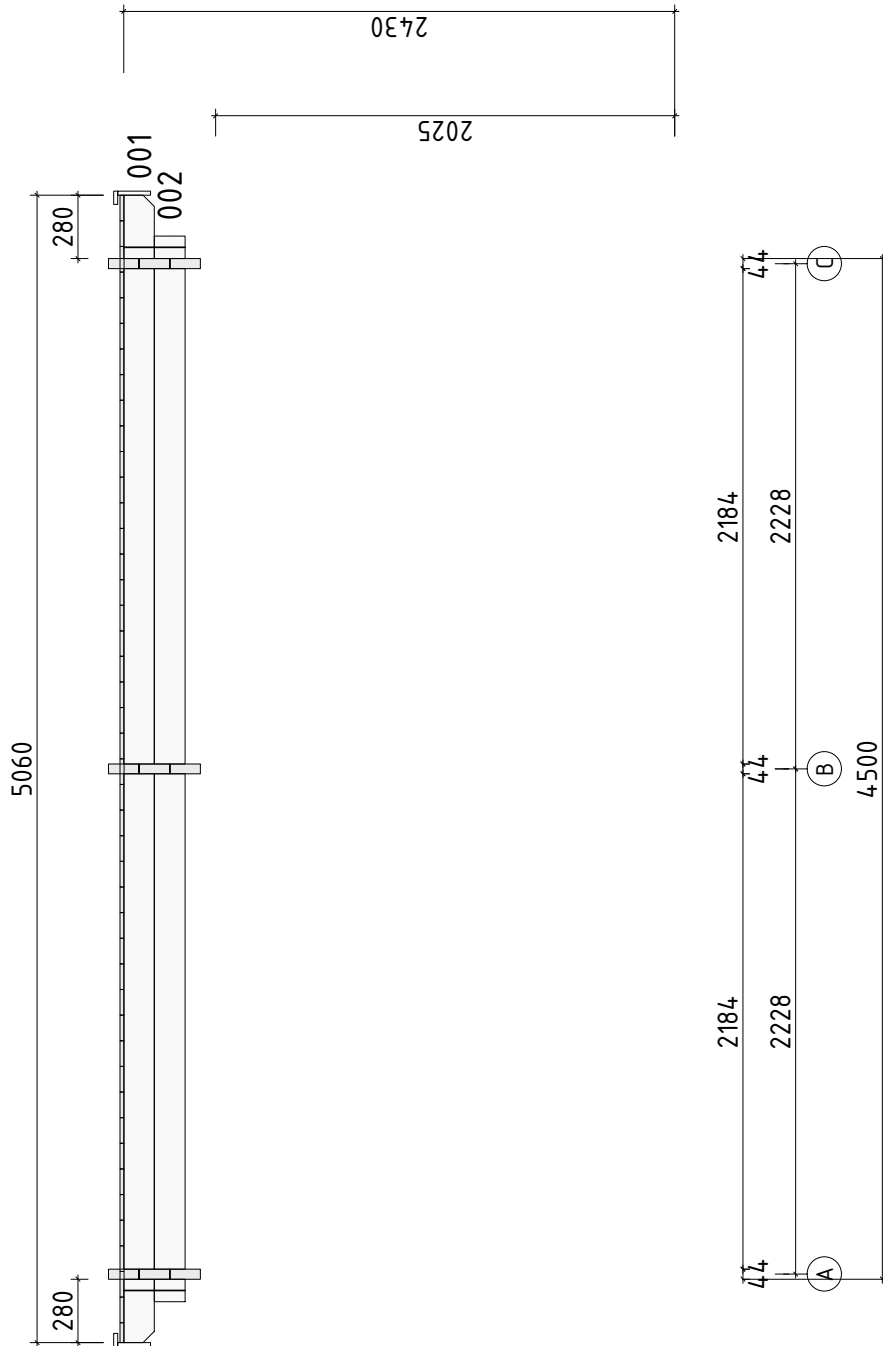

Wand 3 ↗

Wandplan A Flachdach für 845160

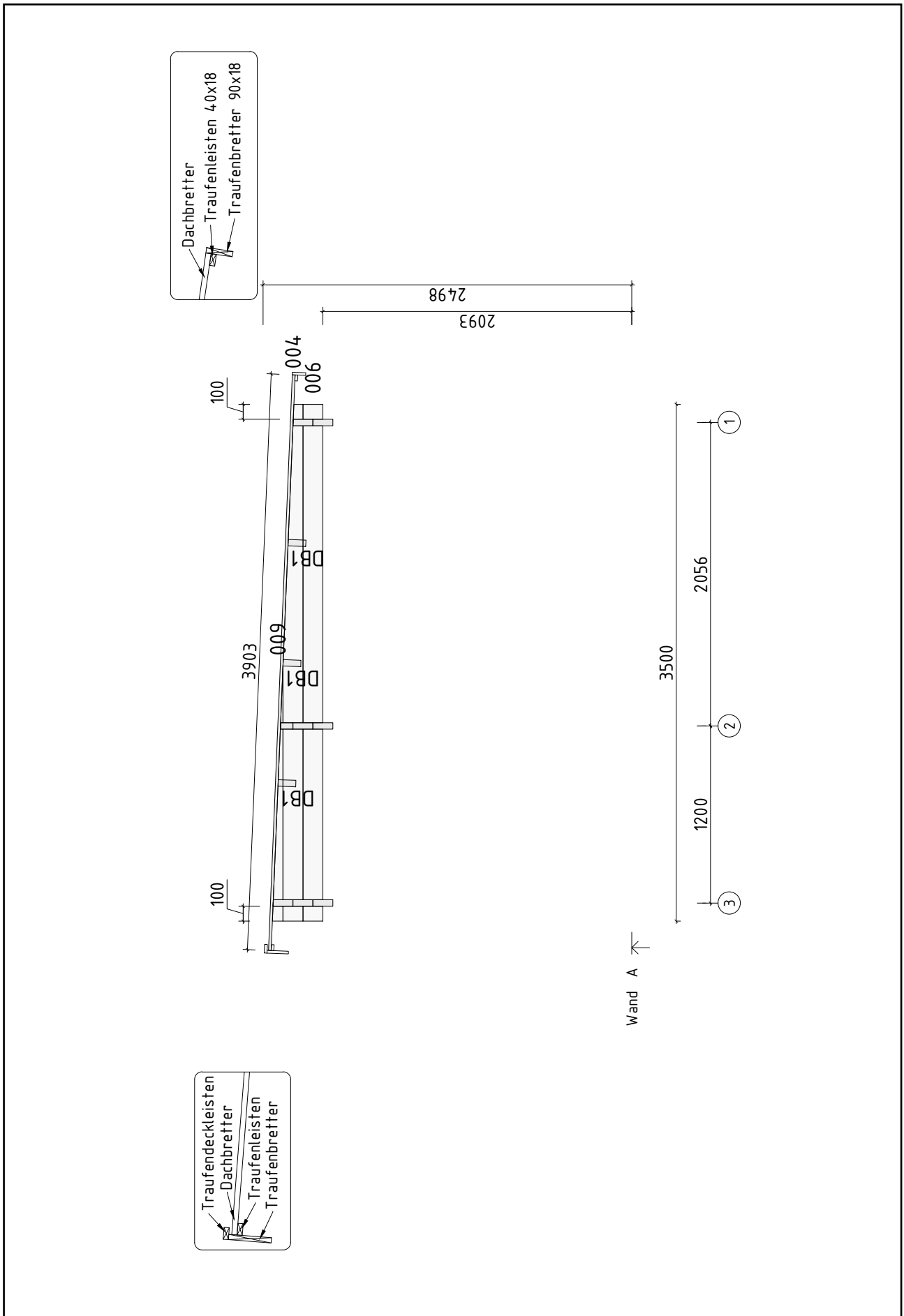

Wandplan B und C Flachdach für 845160

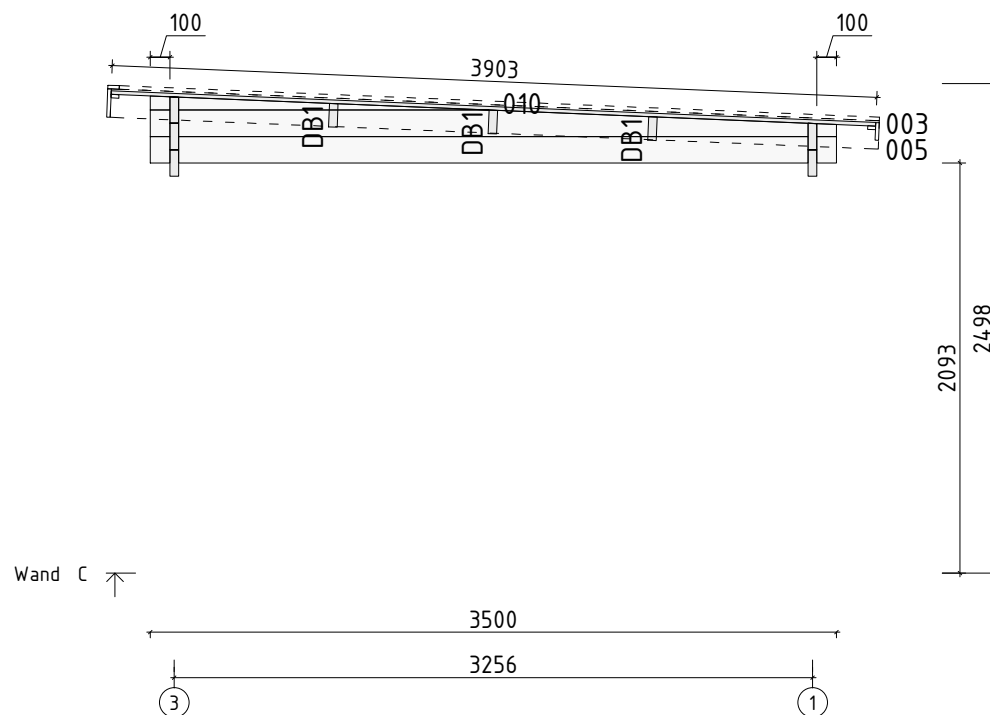
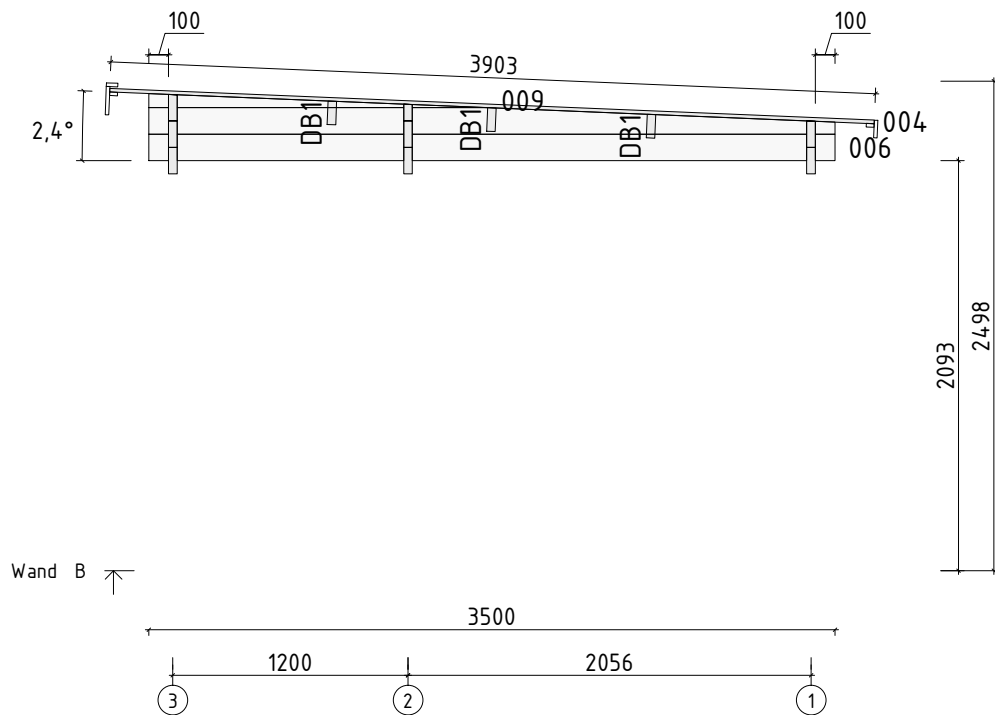

Fenster und Türen

845160



Cordoba 44-A Klassik

Kontrolliert durch:



Achtung: Alle angegebenen Maße sind ca.-Maße!

Teileliste 1

Fenster und Türen 845160

Spezifikation für Fenster und Türen

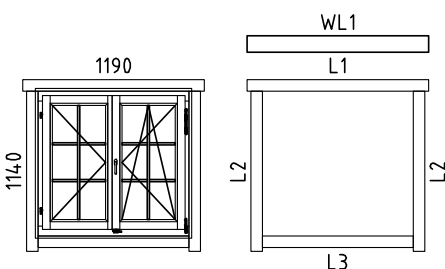
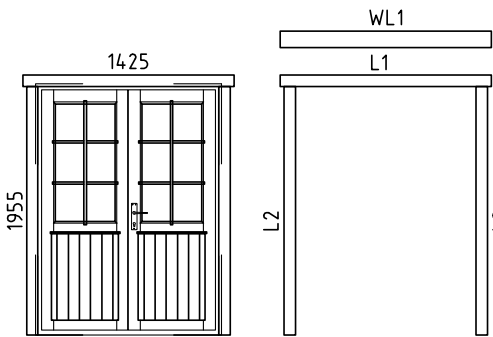
Modell Cordoba A - Set KLASSIK

	<p>FENSTER 1190x1140</p>  <p>A68-7</p> <p>L1 18x90 L=1430mm 2 Stck. L2 18x90 L=1260mm 4 Stck. L3 18x90 L=1190mm 2 Stck. ✓ WL1 36x129 L=1430mm 1 Stck.</p> <p>Durchgangsmaß: 1034x969</p>	1		
	<p>TÜR 1425x1955</p>  <p>TU3-GH+</p> <p>L1 18x90 L=1665mm 2 Stck. L2 18x90 L=1955mm 4 Stck. ✓ WL1 36x129 L=1665mm 1 Stck.</p> <p>DIN rechts</p> <p>Durchgangsmaß: 1337x1867</p>	1		
SR03	SCHRAUBEN 3.5x45		48	
SR05	SCHRAUBEN 4.0x60		7	

✓ - Bitte selber anpassen

15.03.2017