

Technische Daten: Art.-Nr.: 845020



Kontrolliert durch:

Achtung: Alle angegebenen Maße sind ca.-Maße!

3D-Darstellung und Grundriss 845020

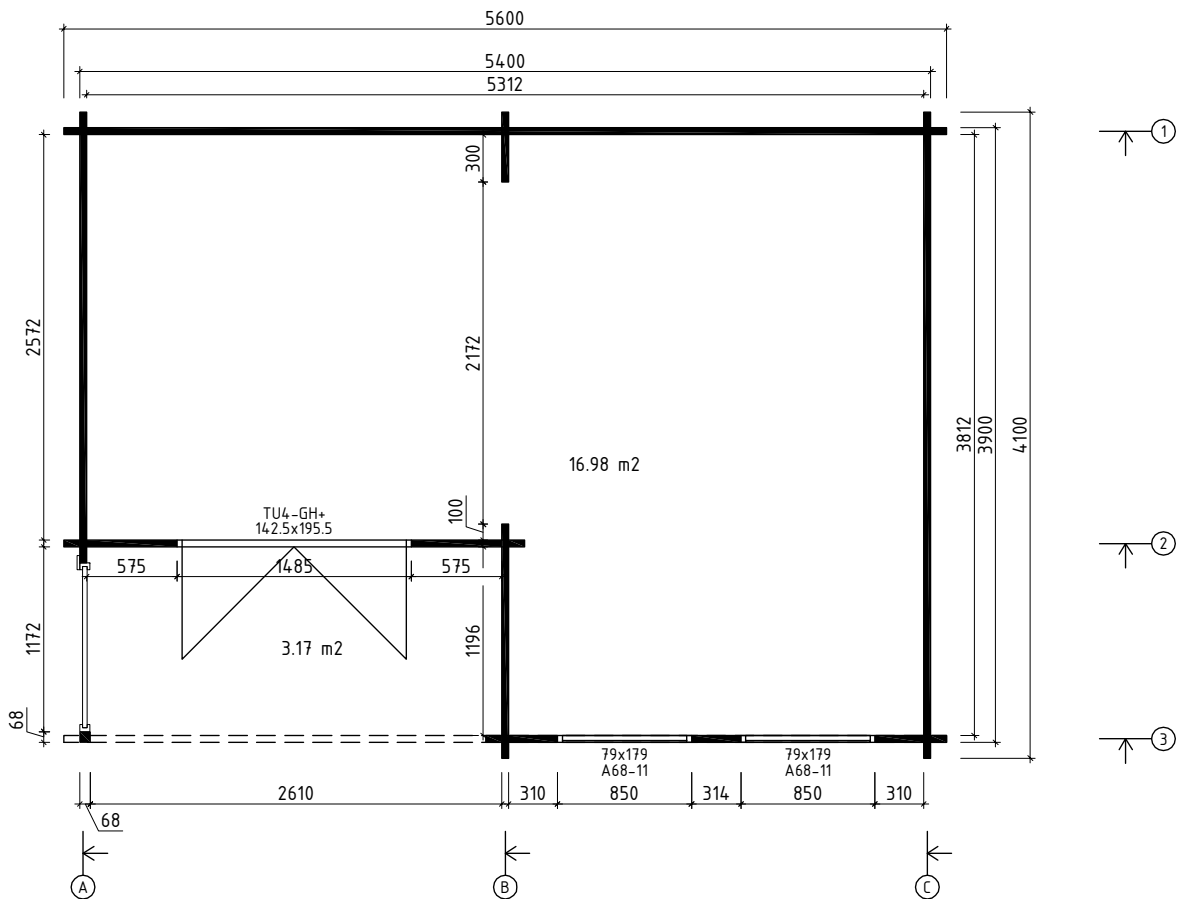
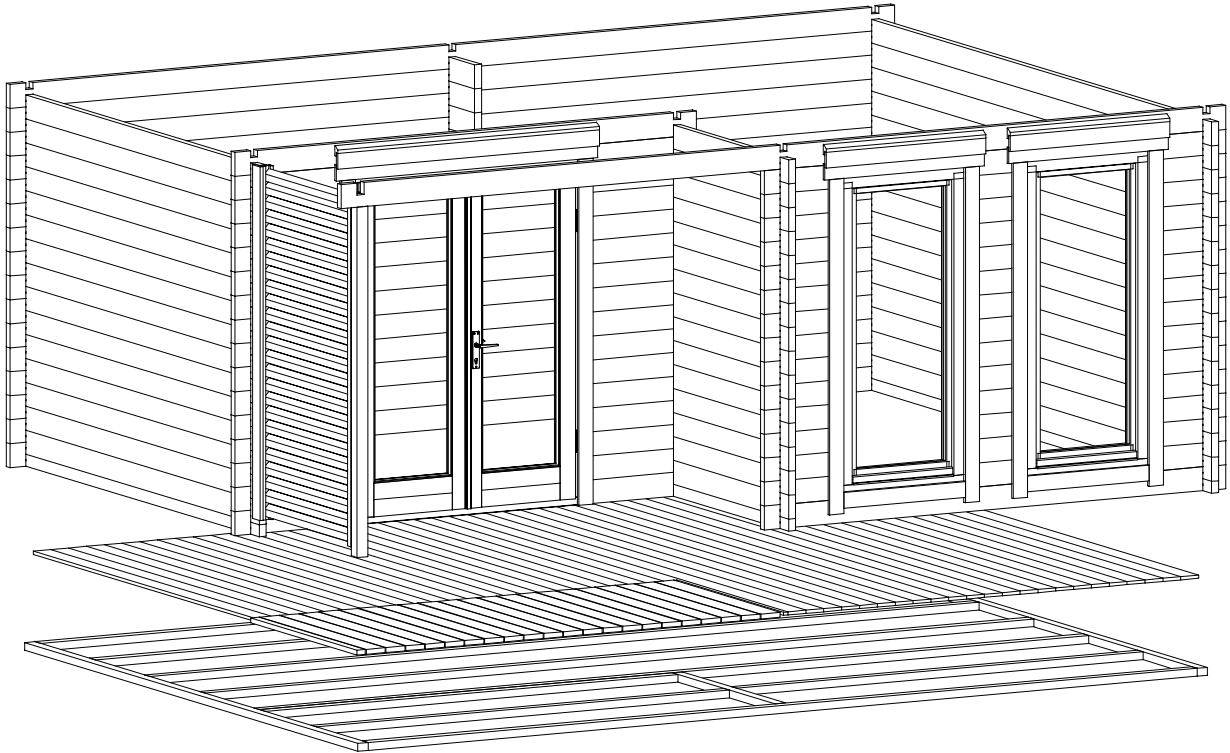

Lagerholzplan und Fundamentplan Korpus für 845020

Wir empfehlen als Fundament für Ihr Gartenhaus eine vollflächig,
festgegründete gepflasterte oder betonierte Fläche.
Wahlweise ist auch ein Punkt- oder Streifenfundament möglich.

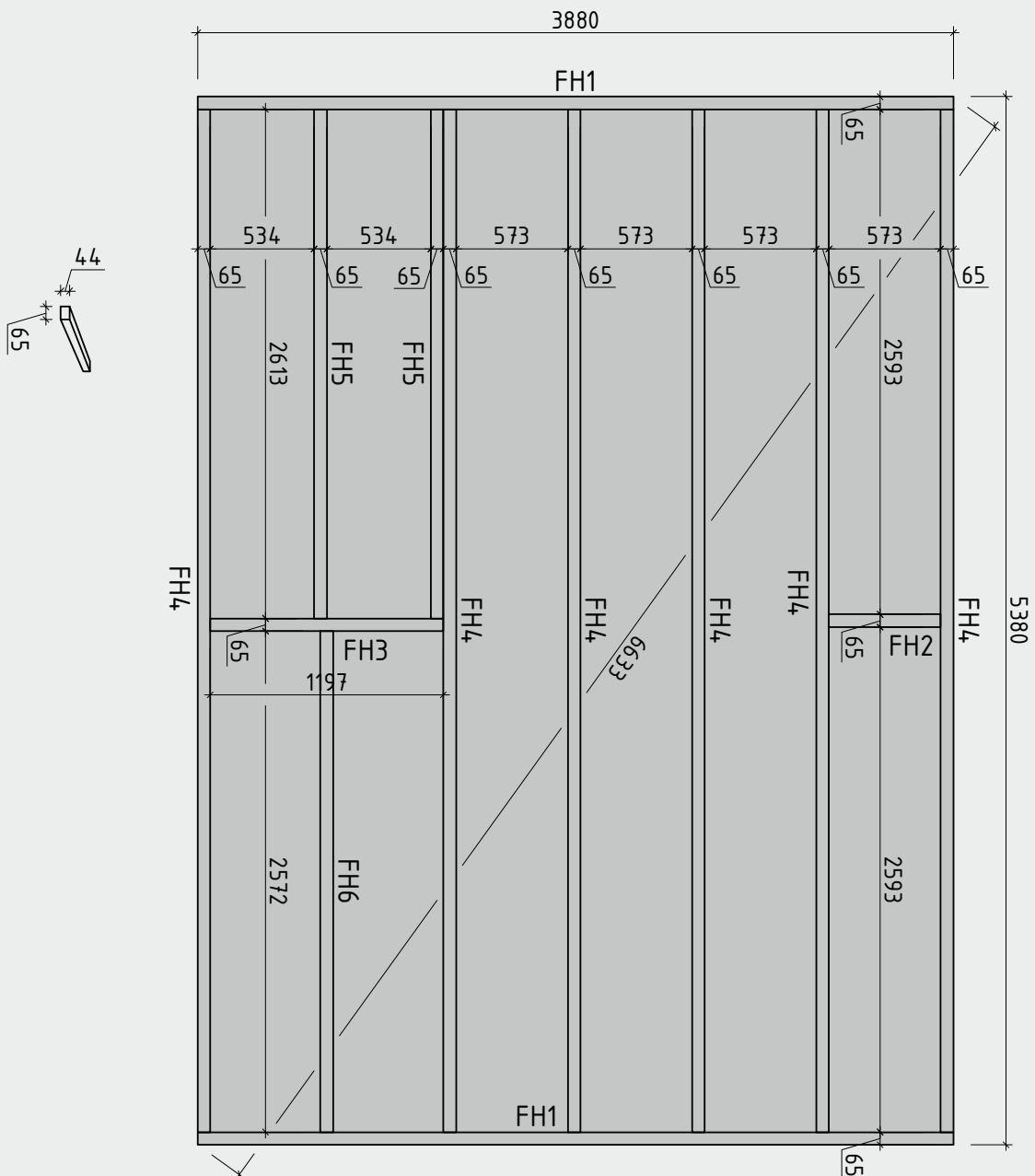













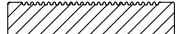

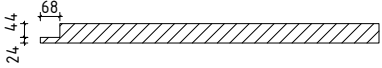
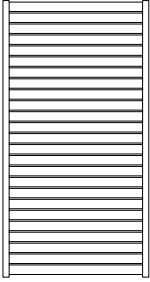





Teilleiste 1

Korpus für 845020

Pos		Stck	Profil (mm)	Länge (mm)
001		16	44x135	5600
002		1	44x135	5600
003		15	44x135	4100
004		1	44x68	4100
005		1	44x135	2922
006		1	44x135	2922
007		15	44x135	2860
008		1	44x68	2860
009		15	44x135	1484
010		1	44x68	1484
011		30	44x135	718
012		14	44x135	454
013		14	44x135	454
014		6	44x135	444
015		2	44x135	444
016		7	44x135	444
017		1	44x68	444
018		12	44x135	314
019		2	44x135	314
FH4	FUNDAMENTHÖLZER (imprägniert) 	6	65x44	5250
FH1	FUNDAMENTHÖLZER (imprägniert) 	2	65x44	3880
FH5	FUNDAMENTHÖLZER (imprägniert) 	2	65x44	2613
FH6	FUNDAMENTHÖLZER (imprägniert) 	1	65x44	2572
FH3	FUNDAMENTHÖLZER (imprägniert) 	1	65x44	1197
FH2	FUNDAMENTHÖLZER (imprägniert) 	1	65x44	573

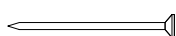
Teileliste 2

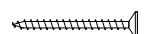
Korpus für 845020

Pos		Stck	Profil (mm)	Länge (mm)
	FUSSBODENBRETTER 	24+1	113x18	3805
	FUSSBODENBRETTER 	23	113x18	2565
	TERRASSENBRETTER (imprägniert) 	22+1	120x28	1240
	FUSSBODENLEISTE  ✓		18x40	19,0 lfm
SP1-1	STÜTZPFOSTEN 68x68  ✓	1	68x68	2095
	GITTERWAND ELEMENT 	1	1072x1994	
	LEISTE FÜR GITTERWAND 	1	18x90	1994
SH	Schlaghölzer 	3		
SS02	Schlossschrauben M8x70 Mutter U-Scheibe (für Gitterwand) 	3	M8	
VP1	Verstellbare Pfostenstütze M10 	1	M10	
ML1	Metallstange 	4	D10	1170
KL1	Gewindestange M8 	3	M8	2000
KL2	Gewindestange M8 	1	M8	460
KL3	Gewindestange M8 	2	M8	405
KL4	Gewindestange M8 	2	M8	325
	Mutter M8 U-Scheibe Ø25 	10	M8	
	Befestigungsmutter M8 	3	M8	
NG1	NÄGEL 2.5x50 Fussbodenbretter 	564		
NG2	NÄGEL 2.5x60 Terrassenbretter 	132		
SR01	SCHRAUBEN 3.0x30 Fussbodenleisten 	42		
SR03	SCHRAUBEN 3.5x45 Gitterwand Fenster- und Türleisten 	86		
SR05	SCHRAUBEN 4.0x60 Wasserleisten WL1 	10		

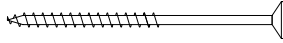
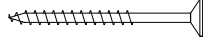
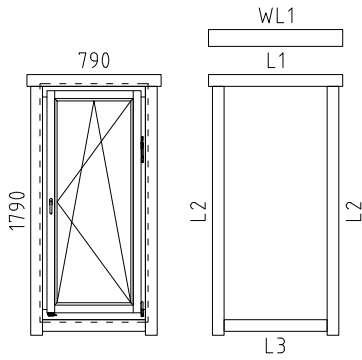
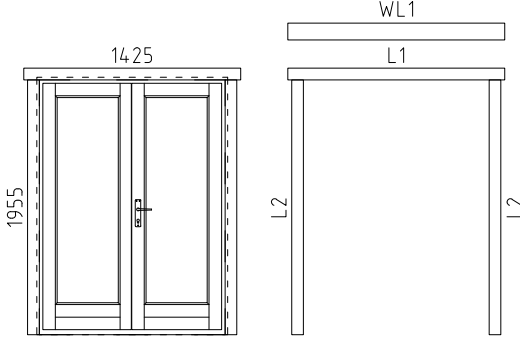
Pos		Stck	Profil (mm)	Länge (mm)
SR11	SCHRAUBEN 5.0x100 Fundamenthölzer 	52		
SR10	SCHRAUBEN 5.0x70 Gitterwand 	4		
	<p style="text-align: center;">FENSTER 790x1790</p>  <p style="text-align: center;">A68-11</p> <ul style="list-style-type: none"> L1 18x90 L=1030mm 2 Stck. L2 18x90 L=1910mm 4 Stck. L3 18x90 L=790mm 2 Stck. ✓ WL1 36x129 L=1030mm 1 Stck. 	2		
	<p style="text-align: center;">TÜR 1425x1955</p>  <p style="text-align: center;">TU4-GH+</p> <ul style="list-style-type: none"> L1 18x90 L=1665mm 2 Stck. L2 18x90 L=1955mm 4 Stck. ✓ WL1 36x129 L=1665mm 1 Stck. <p>DIN rechts</p>	1		
	✓ - bitte selber anpassen (falls nötig!)			

Teileliste 3

Korpus für 845020

Montageanleitung für Gitterwand

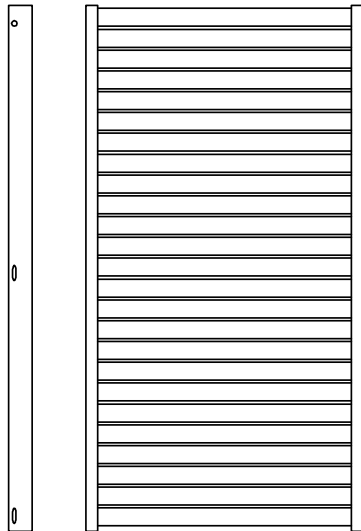

Schrauben 3.5*45mm

6 Stck.



Schrauben 5x70mm

4 Stck.

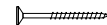

Schlossschrauben M8x70
Mutter U-Scheibe

3 Stck.

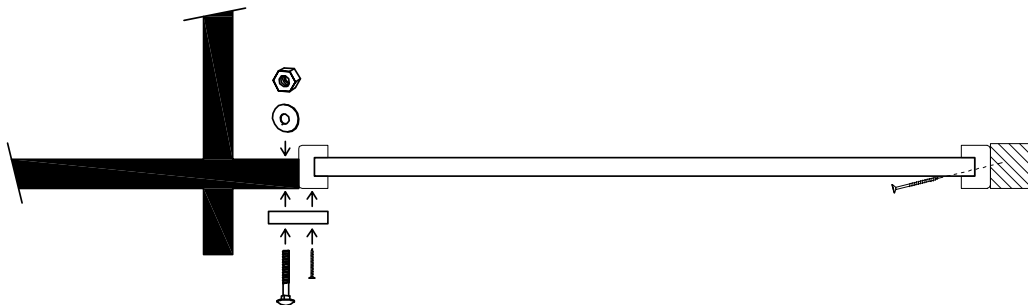
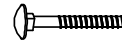

Spiegelverkehrt



Wandplan 1 und 2

Korpus für 845020

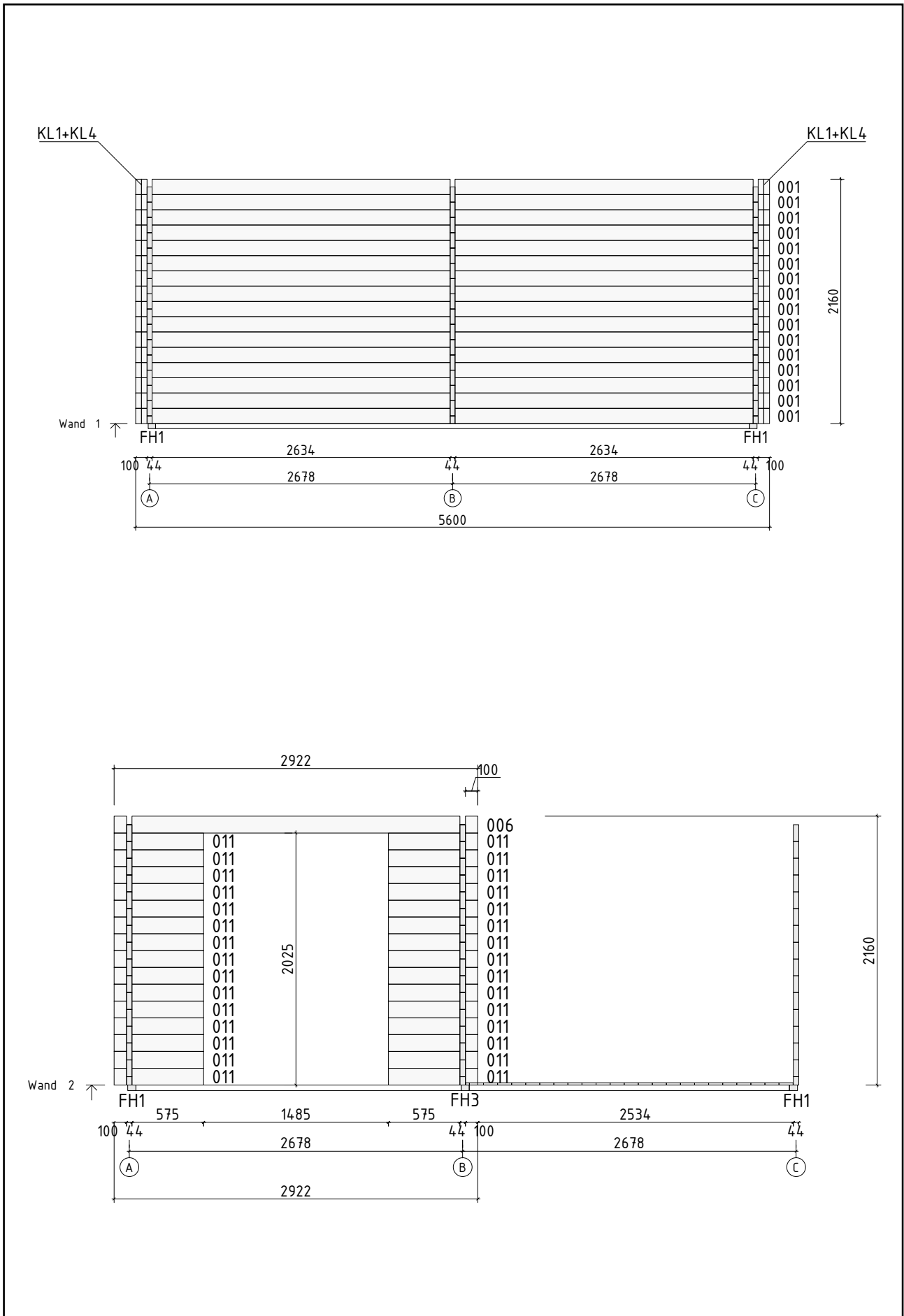

Wandplan 3 Korpus für 845020

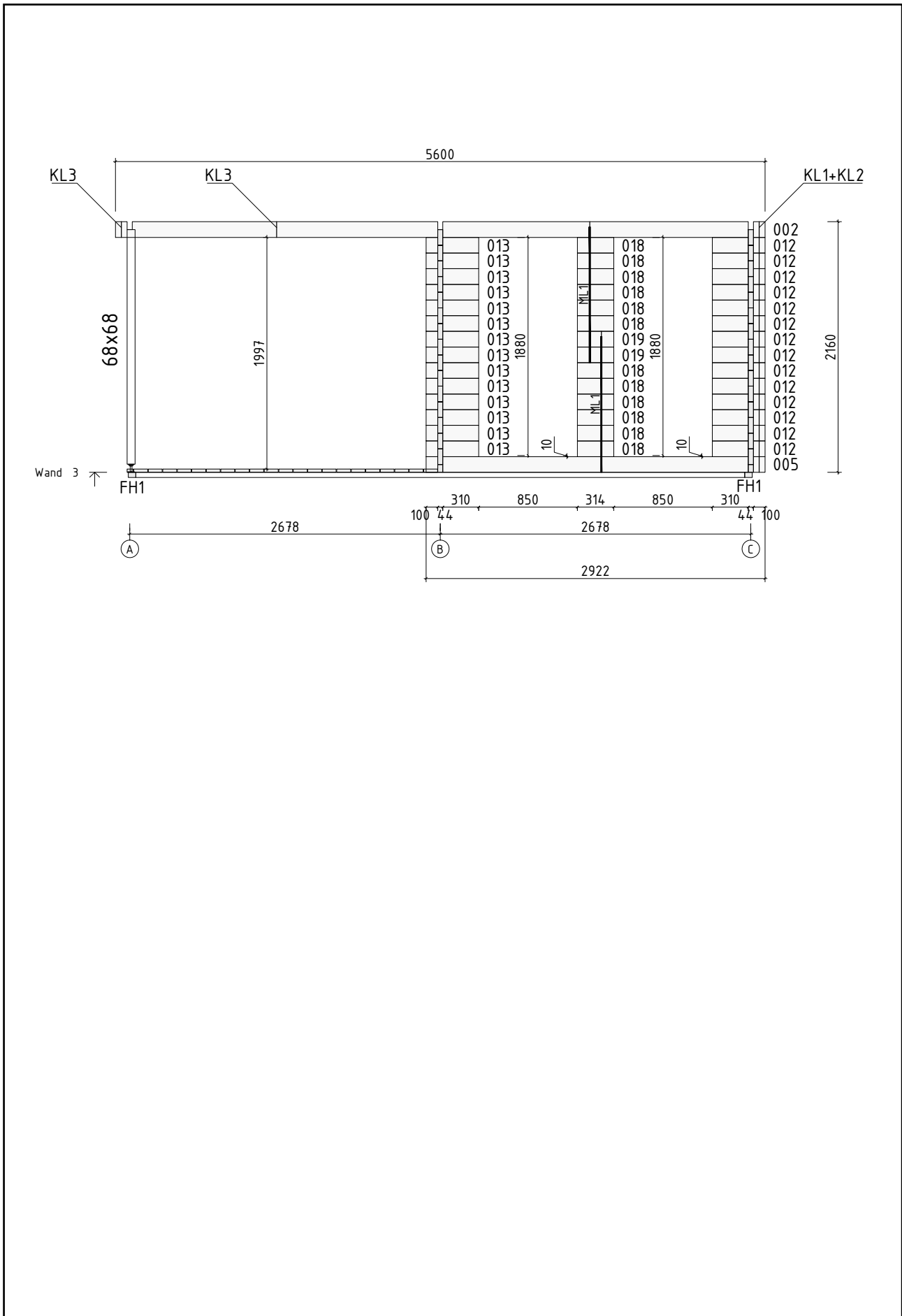

Wandplan A und B Korpus für 845020

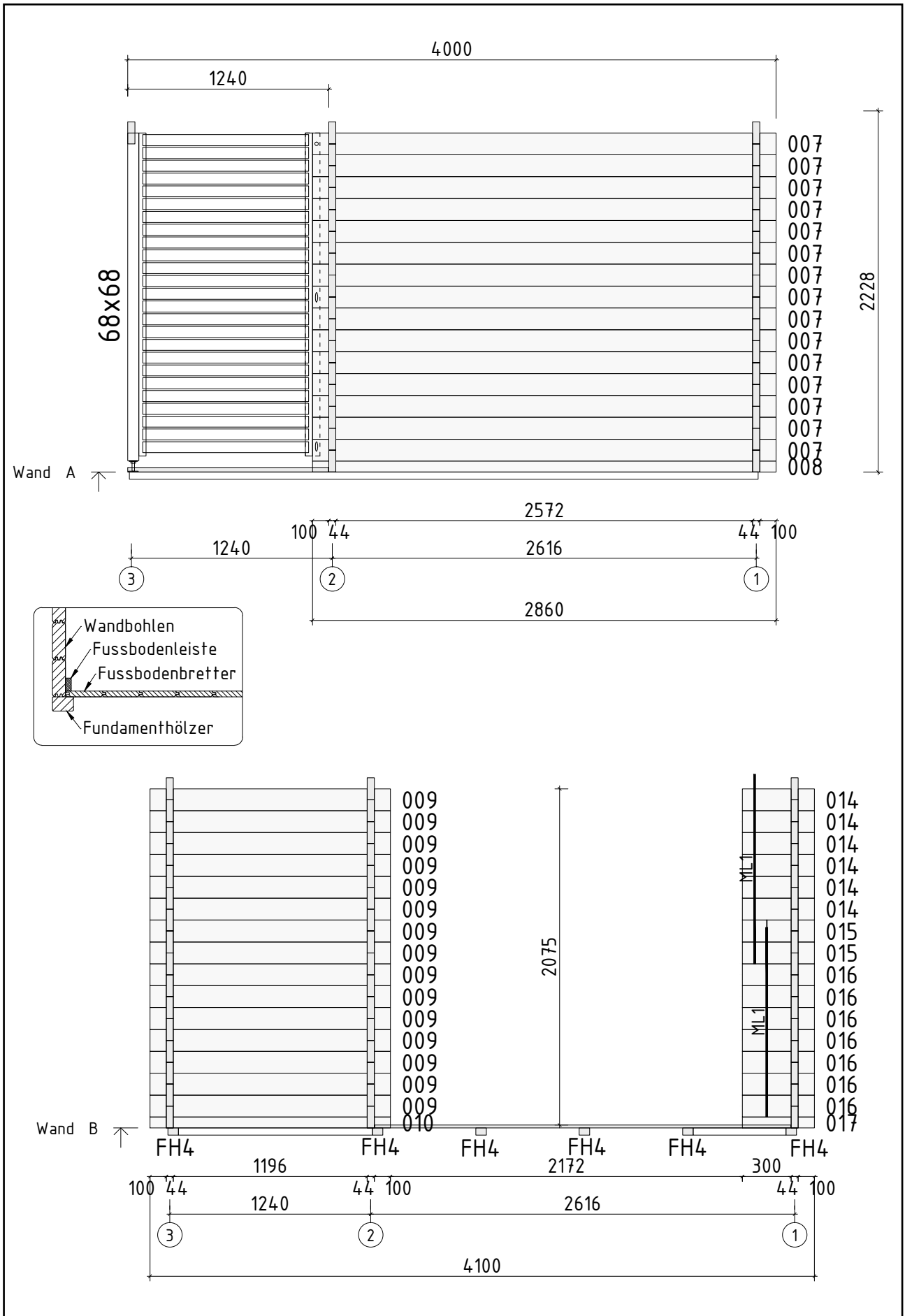

Wandplan C

Korpus für 845020

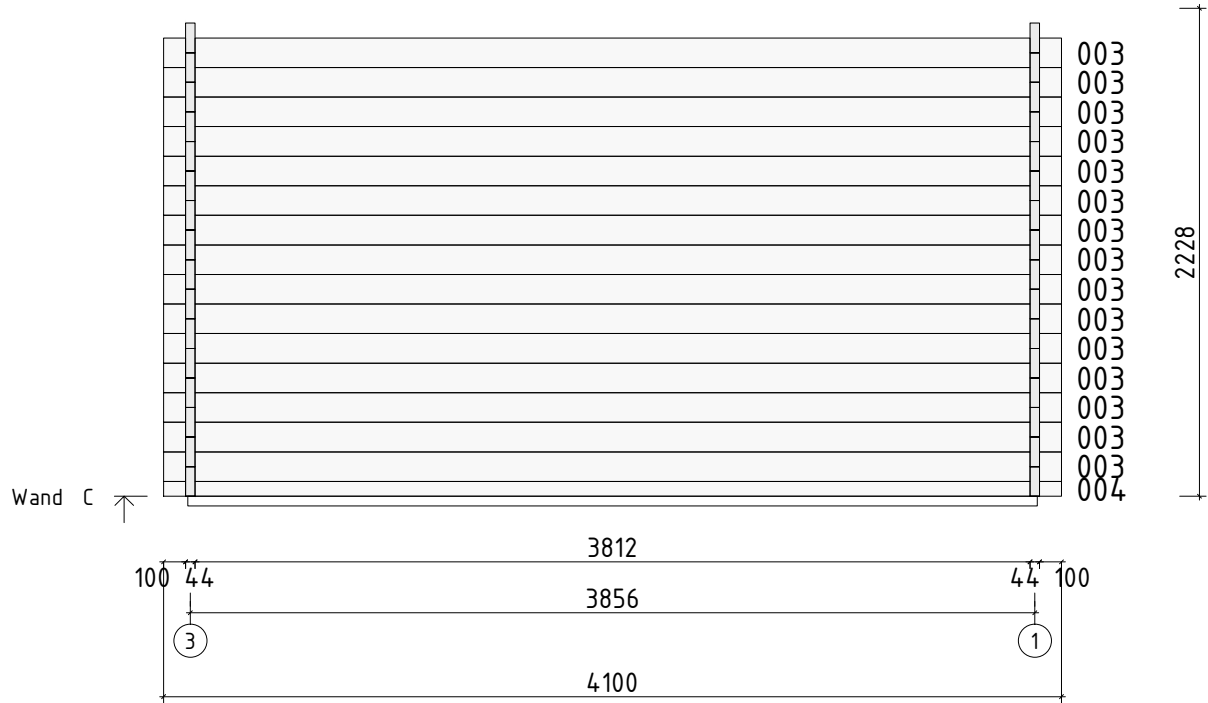

Giebeldach für 845020



Malaga 44-B Modern

Kontrolliert durch:

Achtung: Alle angegebenen Maße sind ca.-Maße!

3D-Darstellung und Grundriss Giebeldach für 845020

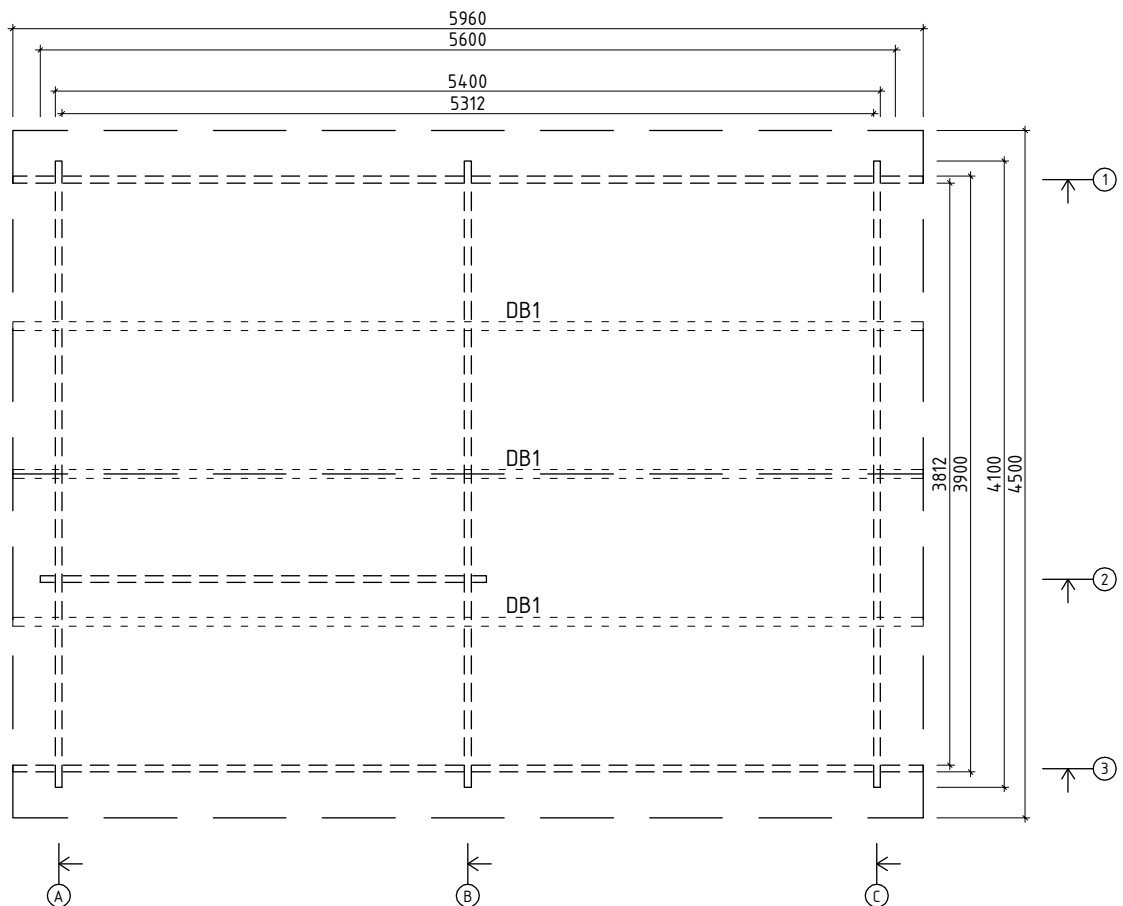
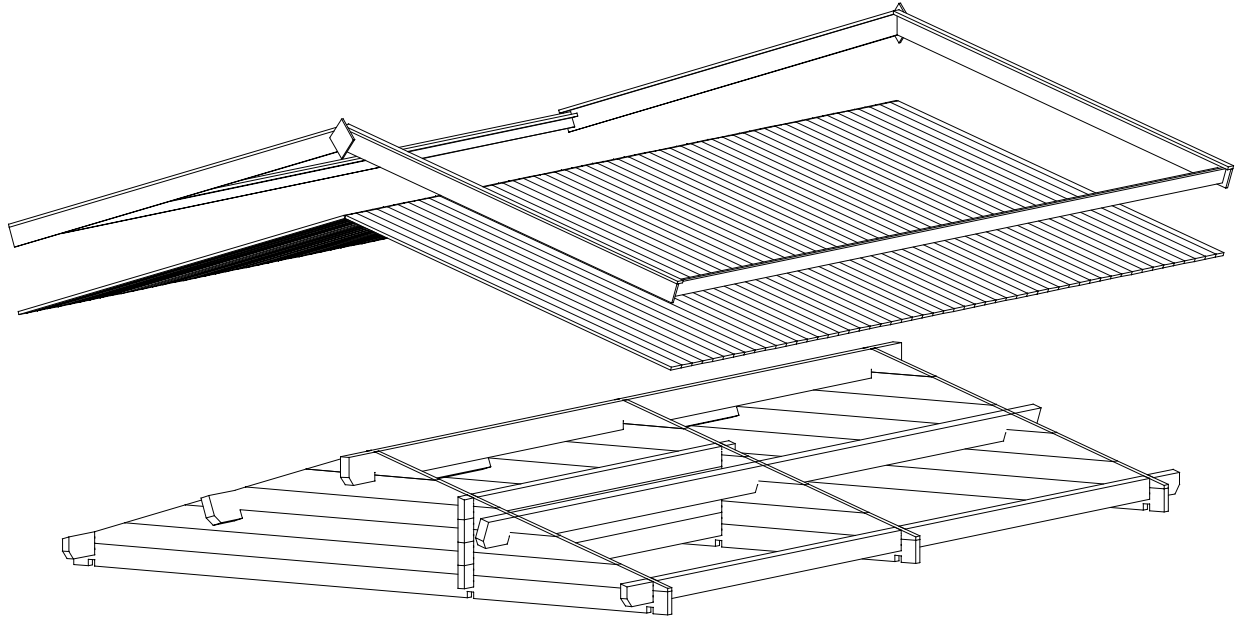

Teilleiste 1

Giebeldach für 845020

Pos		Stck	Profil (mm)	Länge (mm)
001		1	44x135	5960
002		1	44x135	5960
003		2	44x135	4100
004		1	44x135	4100
005		1	44x135	4100
006		1	44x135	4100
007		1	44x135	4100
008		2	44x135	3395
009		1	44x135	3395
010		1	44x131	2922
011		3	44x135	2922
012		2	44x135	2561
013		1	44x135	2561
014		2	44x135	1726
015		1	44x135	1726
016		6	44x135	422
DB1		3	58x170	5960
	DACHBRETTER	106+2	113x18	2365
G1-1	GIEBELBRETTER 120X18	4	120x18	2445
G5-1	GIEBELDECKLEISTE 58X18	4	58x18	2445
T2-1	TRAUFENBRETTER 90X18	2	90x18	5960
T4-1	TRAUFENLEISTE 40x18		40x18	12,0 lfm
GS	Giebelsegment	2		
SH	Schlaghölzer	3		
NG1	NÄGEL 2.5x50 Dachbretter	636		

Teilleiste 2

Giebeldach für 845020

Pos			Stck	Profil (mm)	Länge (mm)
SR01	SCHRAUBEN 3.0x30 Traufenleisten 40x18 		24		
SR03	SCHRAUBEN 3.5x45 Giebelbretter, Traufenbretter Giebelsegment 		68		
	✓ - bitte selber anpassen (falls nötig!)				

Wandplan 1 und 2 Giebeldach für 845020

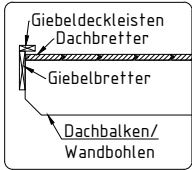
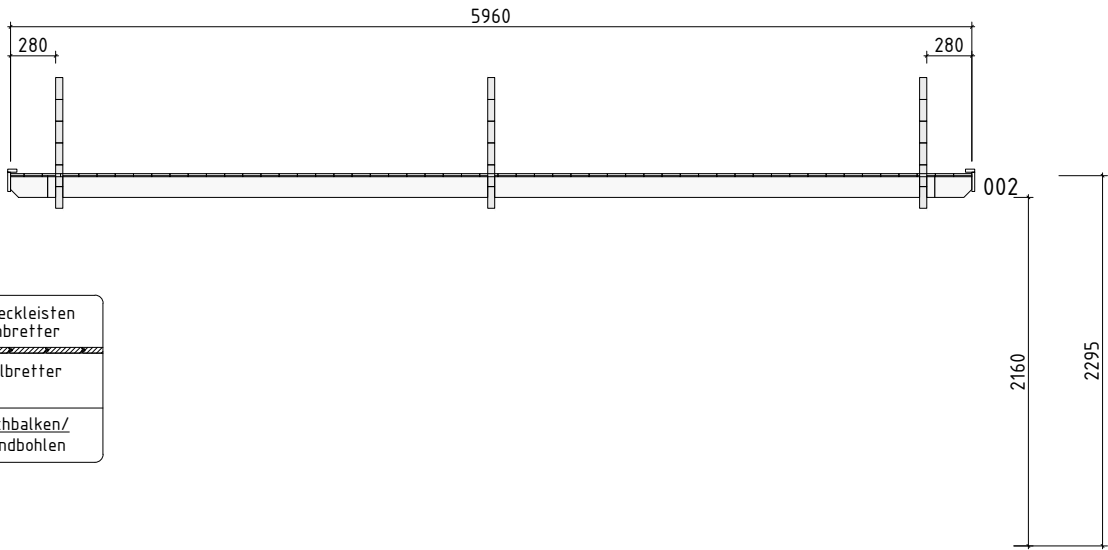

Wand 1 ↗

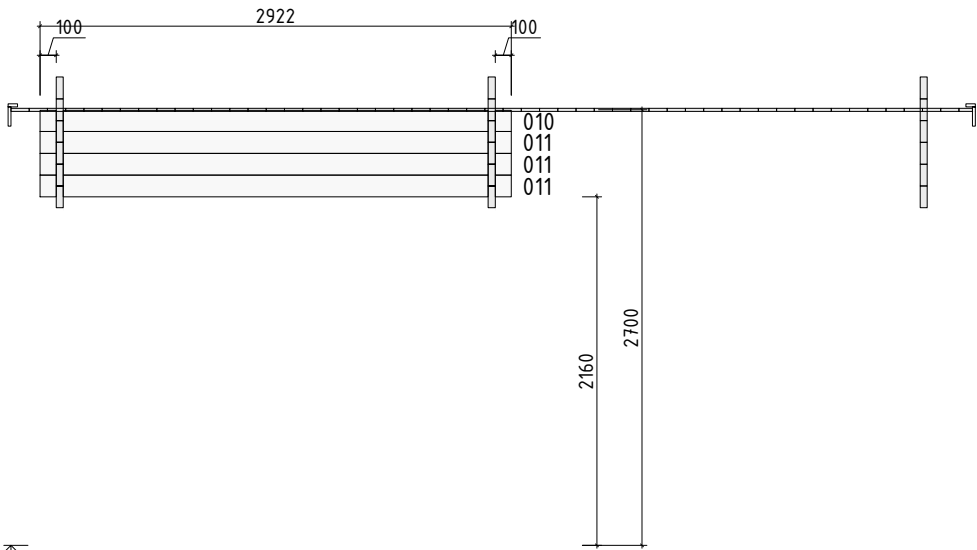
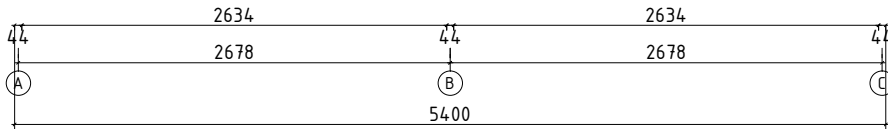

Wand 2 ↗

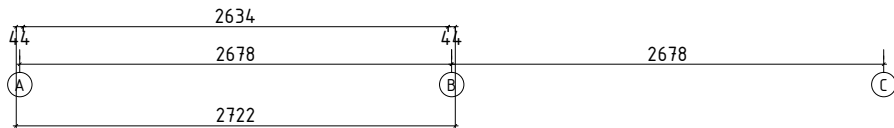

Wandplan 3

Giebeldach für 845020

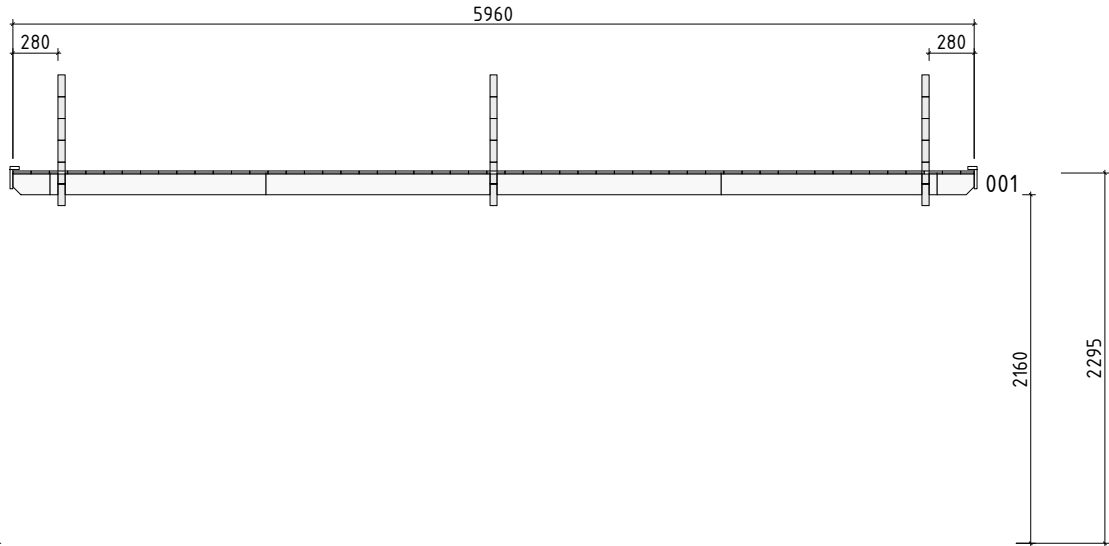

Wand 3 ↗

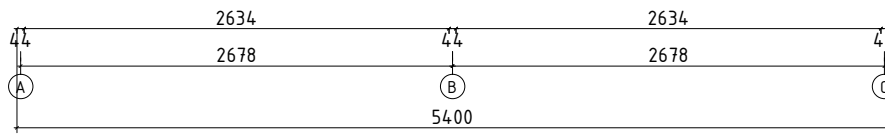

Wandplan A und B Giebeldach für 845020

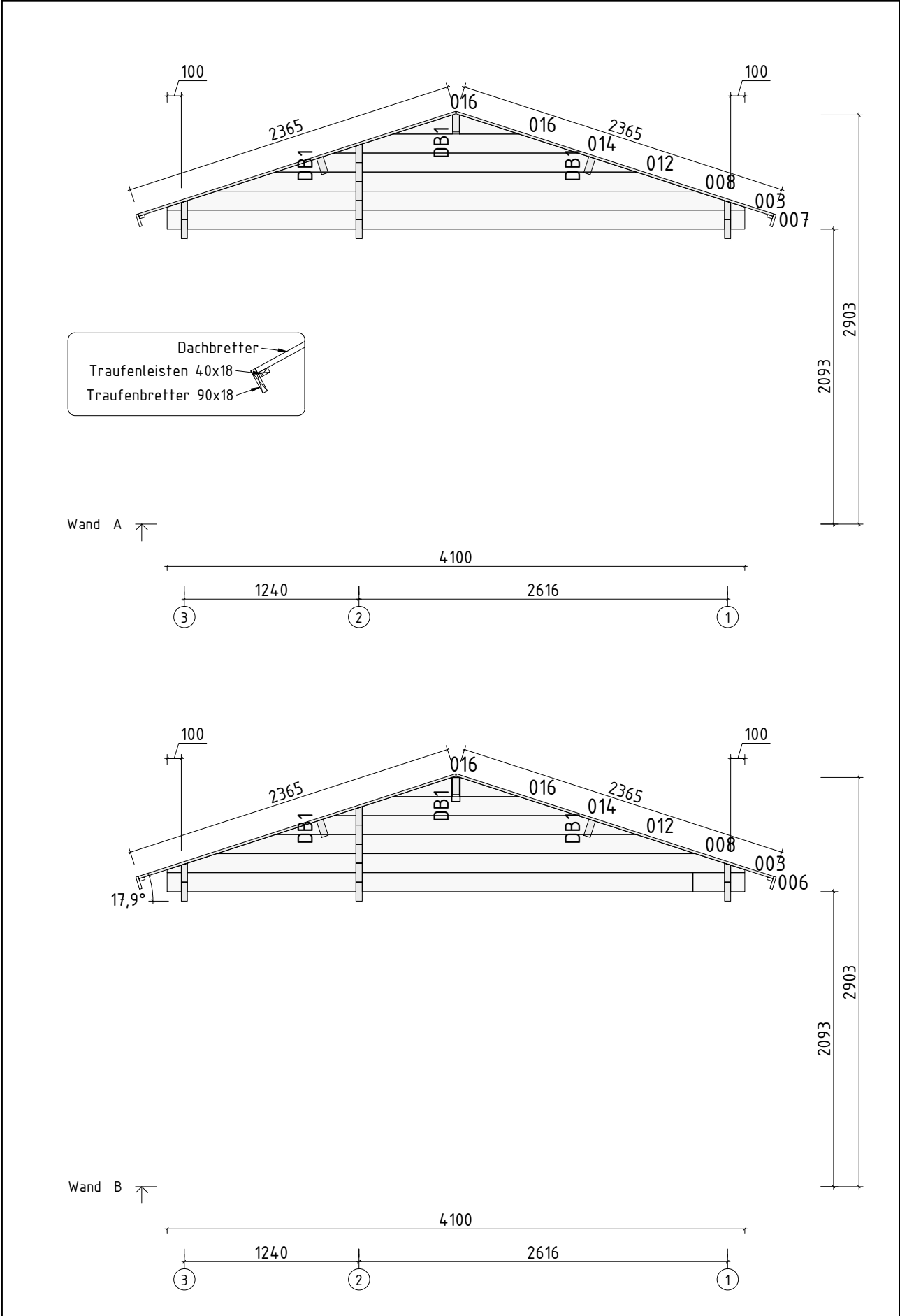

Wandplan C

Giebeldach für 845020

