

Technische Daten

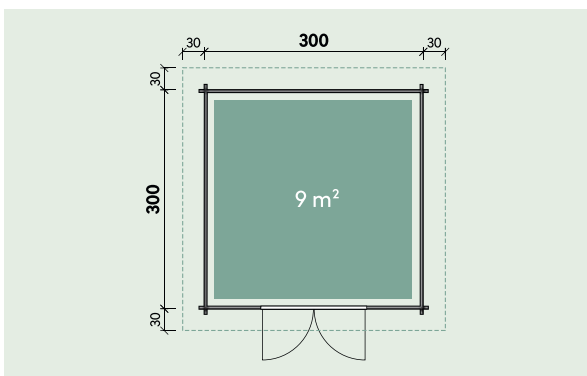

Artikelnummer:

534 362, 830 801, 830 802, 830 803, 830 804



Kontrolliert durch:

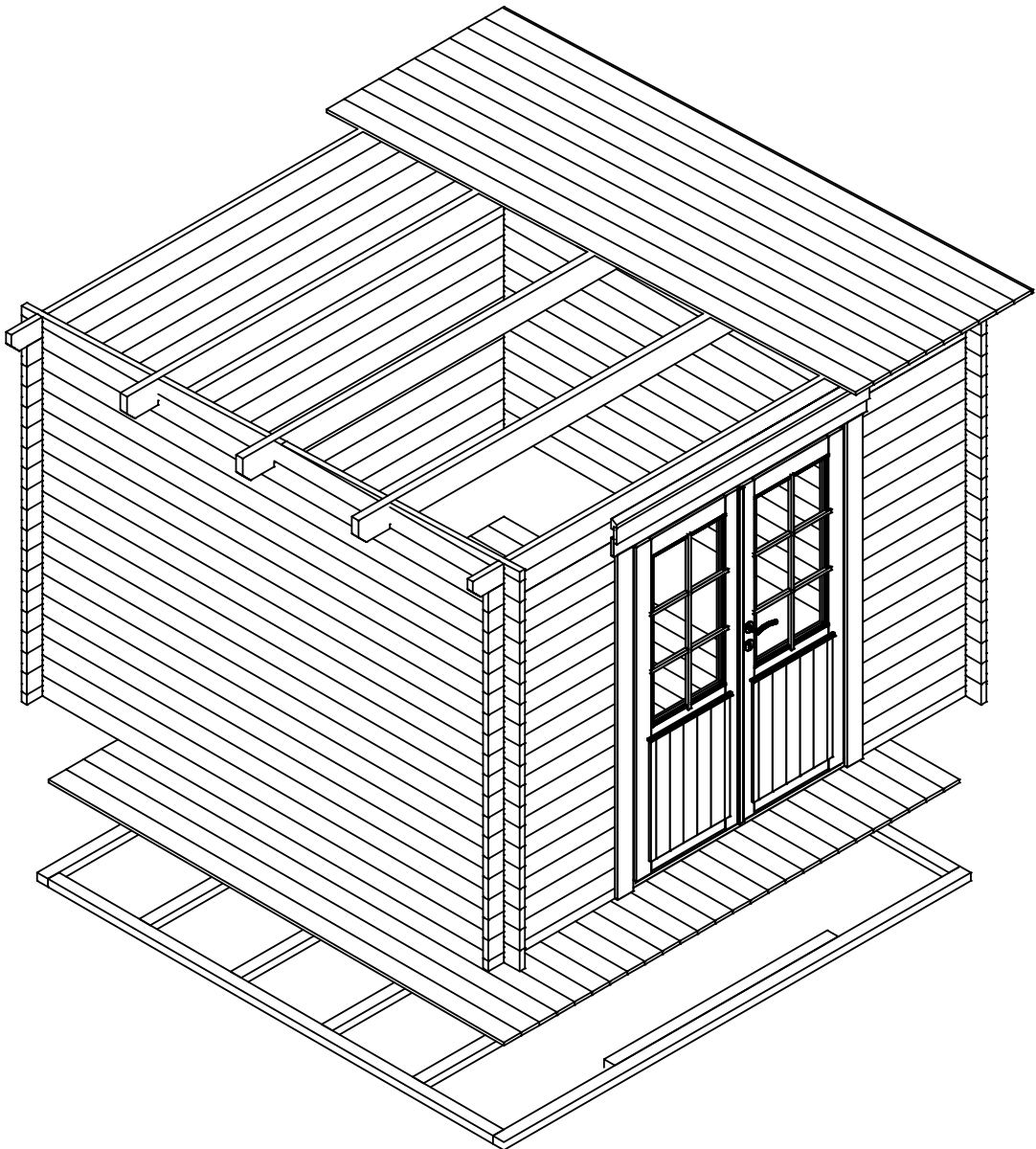

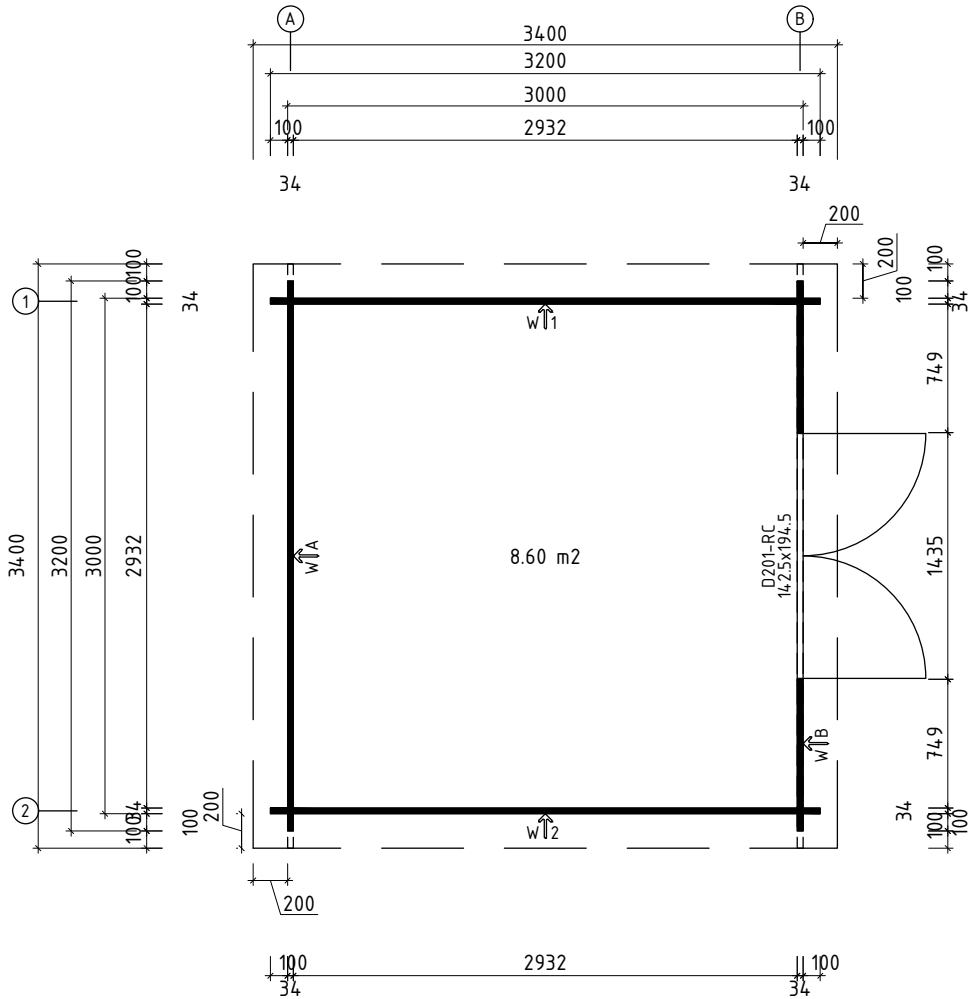







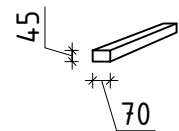
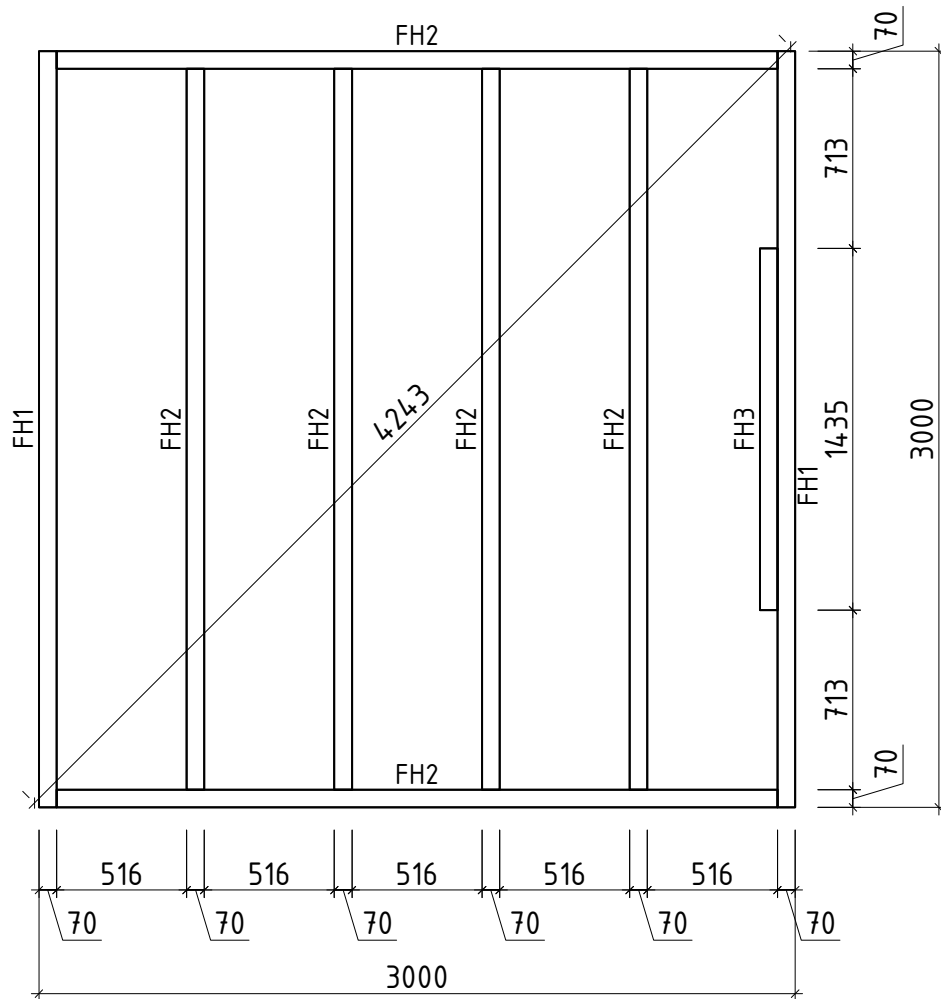

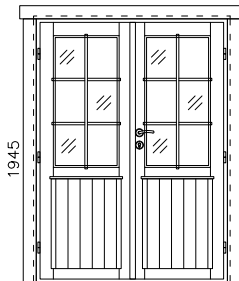

*Fenster und Türen sind mit Sprossen

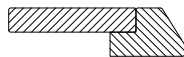
Q4 – Qualitätsklasse für Fenster und Türen

Wir empfehlen als Fundament für Ihr Gartenhaus eine vollflächig festgegründete, gepflasterte oder betonierte Fläche. Wahlweise ist auch ein Punkt- oder Streifenfundament möglich.

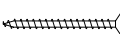
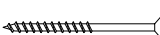
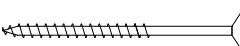

Nr.		Stck	Profil (mm)	Länge (mm)
001		1	34x110	3400
002		1	34x114	3400
004		52	34x114	3200
005		1	34x57	3200
007		34	34x114	883
008		2	34x57	883
W1-1		1		
W2-1		1		
FH1	FUNDAMENTHÖLZER (imprägniert) 	2	70x45	3000
FH2	FUNDAMENTHÖLZER (imprägniert) 	6	70x45	2860
FH3	FUNDAMENTHÖLZER (imprägniert) 	1	70x45	1435
PF1	PFETTEN 	3	44x145	3400
	DACHBRETTER	31+1	113x18	3400
	FUSSBODENBRETTER	26+1	113x18	2925
	FUSSBODENLEISTEN	✓	18x40	13.0lfm
G02-1	GIEBELBRETT 18x120	✓	18x120	3420
G05-1	GIEBELDECKLEISTEN 18x40	✓	18x40	3400
T02-1	TRAUFBRETT 18x120	1	18x120	3436
T01-1	TRAUFBRETT 18x95	1	18x95	3400
T04-1	TRAUFECKLEISTEN 18x40	1	18x40	3436
T06-1	TRAUFECKLEISTEN 18x40	✓	18x40	7.0lfm
SM-1	Sturmleisten	2	18x40	2025
SM-2	Sturmleisten	2	18x40	2140
SH	Schlaghölzer	3		
NG2 550	NÄGEL 2.5x50 Dachbretter	310		

Nr.		Stck	Profil (mm)	Länge (mm)	
	<p style="text-align: center;">TÜR 1425x1945 D4-D34R-56C-14251945</p> <p>Q4 D201-RC 1425</p>  <div style="border: 1px solid black; padding: 5px; margin-top: 10px;"> <p>Right handed / DIN rechts / paremakäeline</p> <p>Clear opening / durchgangsmaß / ava suurus 1297x1837mm</p> <p>double-pane clear float glass ISO Glas 2-fach 2x klaaspakett, kirgas klaas 472x950mm</p> </div>	1			
PROSS H41-1	Q4-1 Muntins - Sprossen - Prossid horizontal 18x18		4	18x18	497
PROSS V42-1	Q4-2 Muntins - Sprossen - Prossid vertical 18x18		2	18x18	975
WL-1	Rain strips - Wasserleisten - Vihmaliistud 36x134		1	36x134	1625
PL3-1	Trims - Rahmenleisten - Piirdeliistud 18x95	 ✓	4	18x95	1925
PL3-2	Trims - Rahmenleisten - Piirdeliistud 18x95	 ✓	2	18x95	1625
SR30 20-01	3.0x20 Locking plate - Schließblech - Riivi vastus 02 Q4-Q5		2		
SR30 22-01	3.0x20ÜP Muntins - Sprossen - Prossid		12		
SR35 45-01	3.5x45 Trims - Rahmleisten - Piirdeliistud		24		
SR40 60-01	4.0x60 Rain strip - Wasserleiste - Vihmaliist		4		
SR50 90-01	5.0x90 Door frames - Türrahmen - Ukselengid		8		
RV02	Locking plate - Schließblech - Riivi vastus 02 Q4-Q5		1		
LS-Q4	Q4 Cylinder lock - Zylinderschloss - Lukusüdamik		1		
UL-Q4	Q4 Door handle - Türgriff - Ukselink		1		
	✓ - bitte selber anpassen (falls nötig)!				

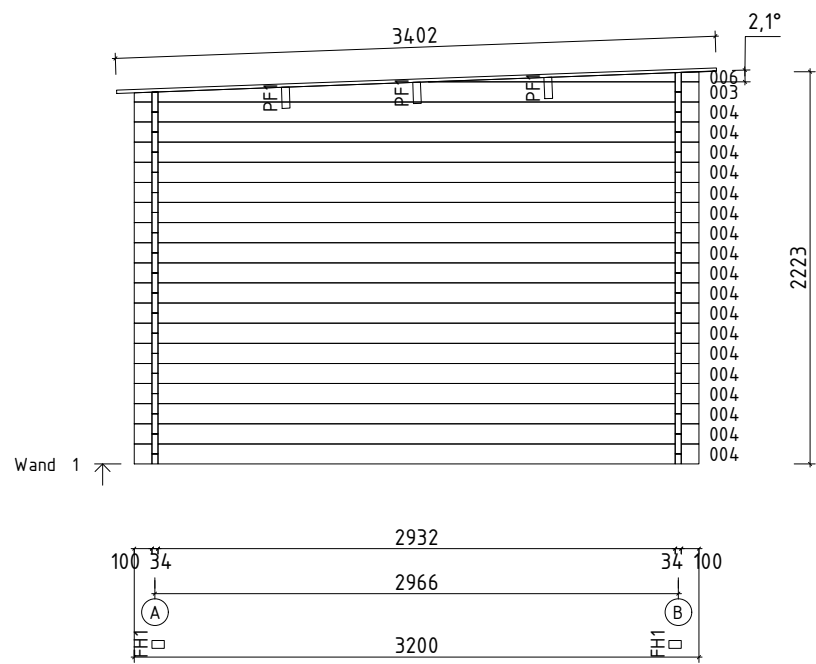

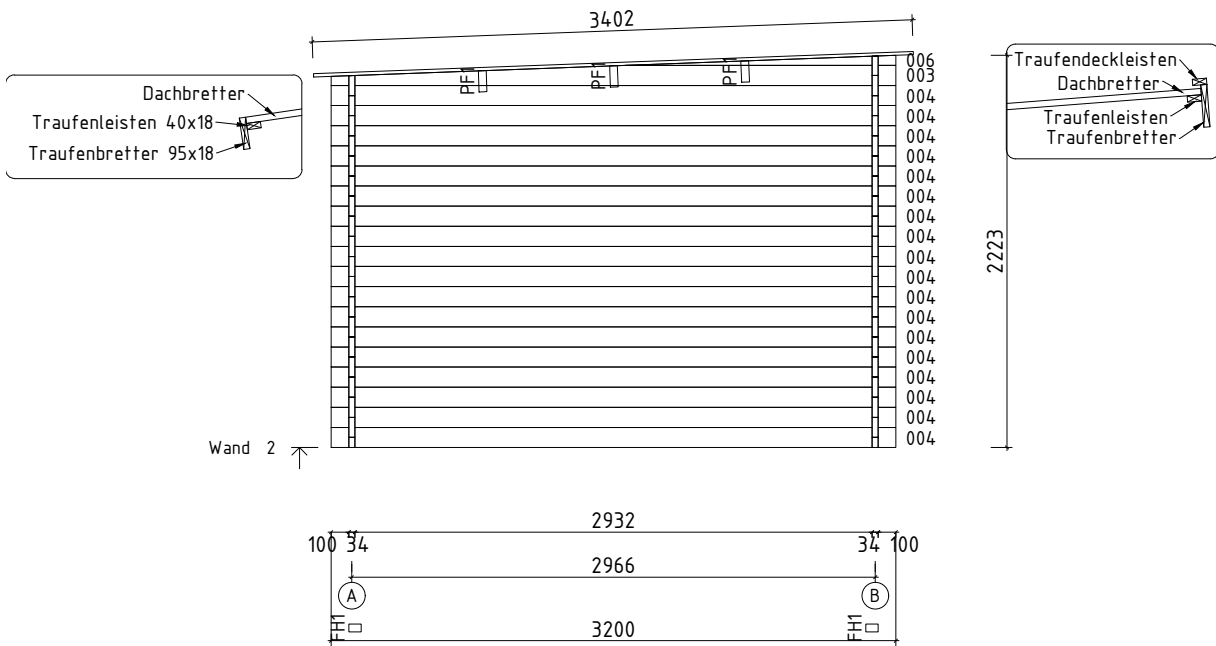

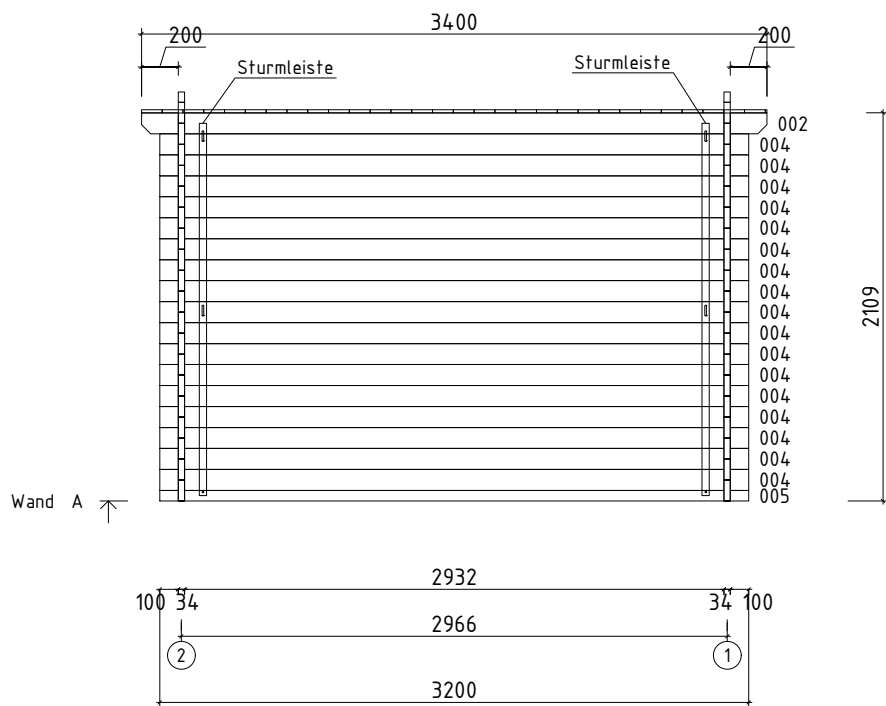

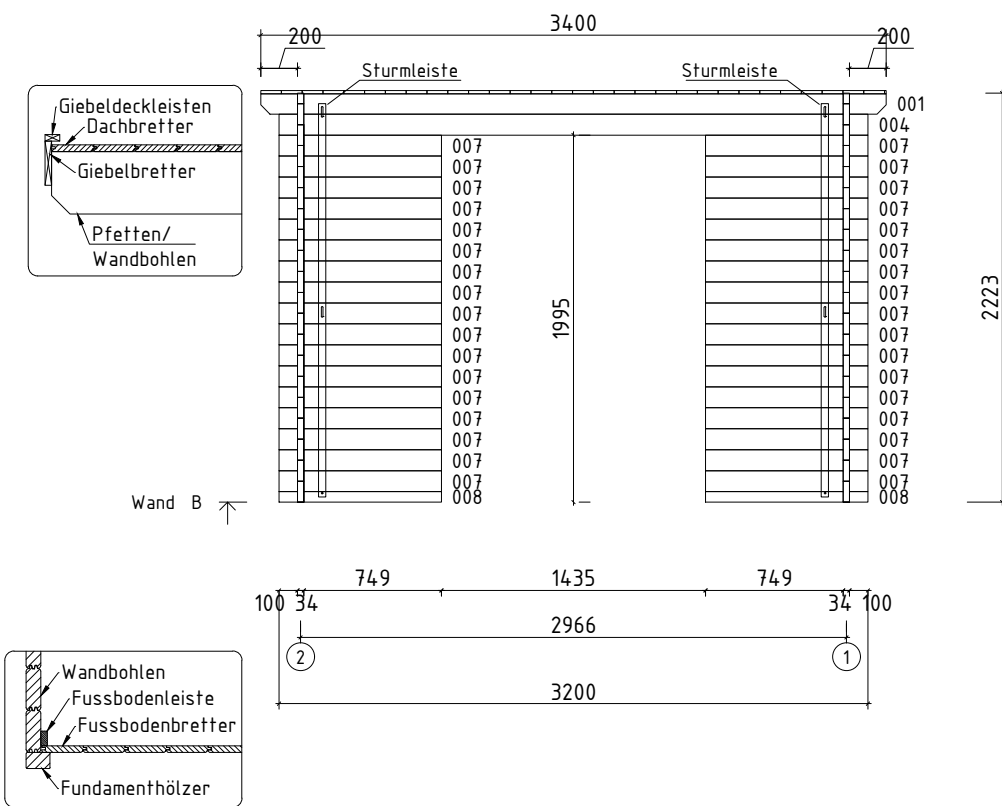

Rain strip / Wasserleiste / Vihmaliist

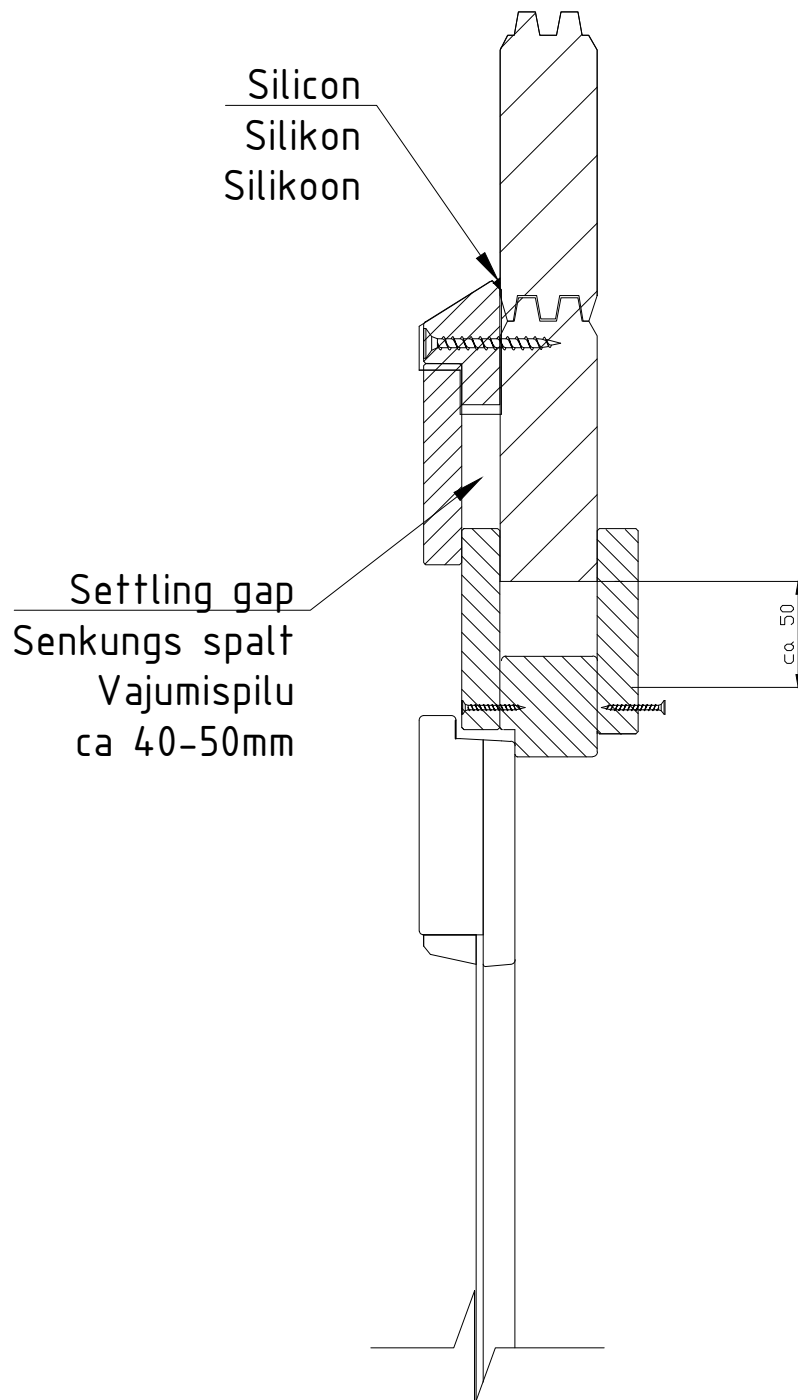

NB!

- Install only if the item is listed in the house specification!
- Nur montieren wenn die Leiste in der Teileliste gezeigt ist!
- Monteerida juhul, kui liist on välja toodud maja spetsifikatsioonis!

Uks Q2-Q3 - koostamisjuhised
 Door Q2-Q3 - assembly instructions
 Tür Q2-Q3 - Montageanleitung

