

# Technische Daten



FARB-BEHANDLUNG
Fichte
Bernstein
Gletschergrau
Felsgrau

## Artikelnummer:

228 310 ist Bestandteil von  
830 731, 830 732, 830 733, 830 734

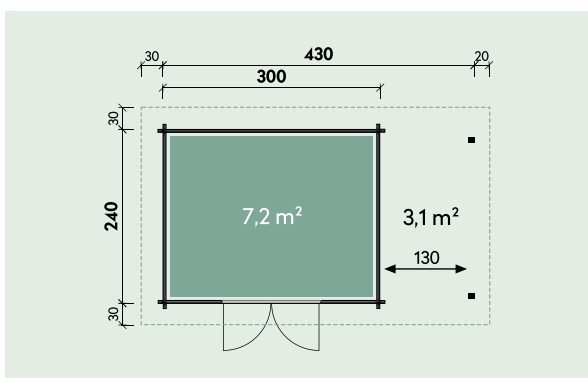

Kontrolliert durch:

**Technische Daten: Art.-Nr.: 228 310**

**Wandaußenmaß: 240 x 300 cm**

**Bohlenstärke: 28 mm**



**Kontrolliert durch:**

Achtung: Alle angegebenen Maße sind ca.-Maße!

# 3D-Darstellung Art.-Nr. 228 310

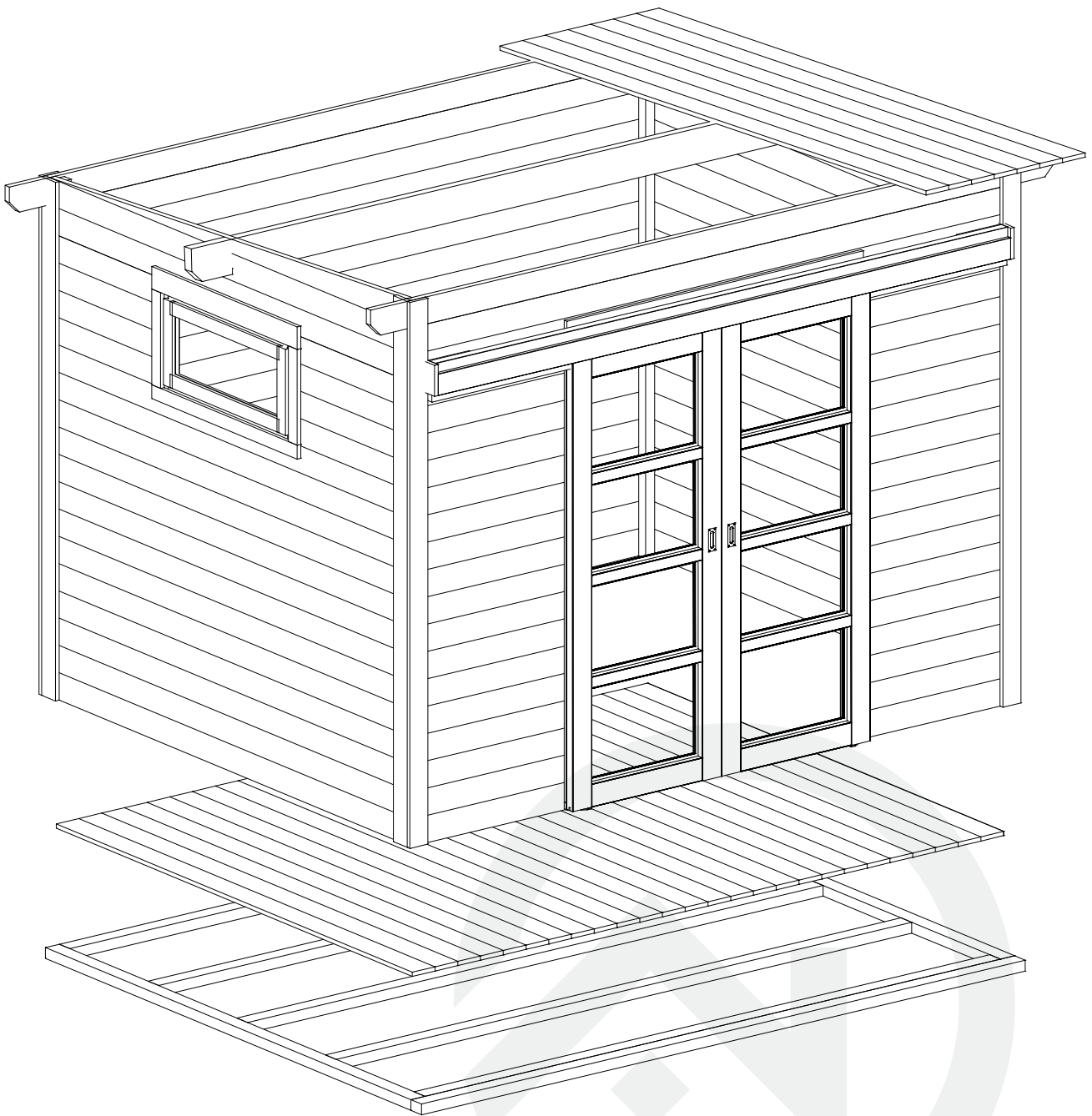

# Grundriss

## Art.-Nr. 228 310

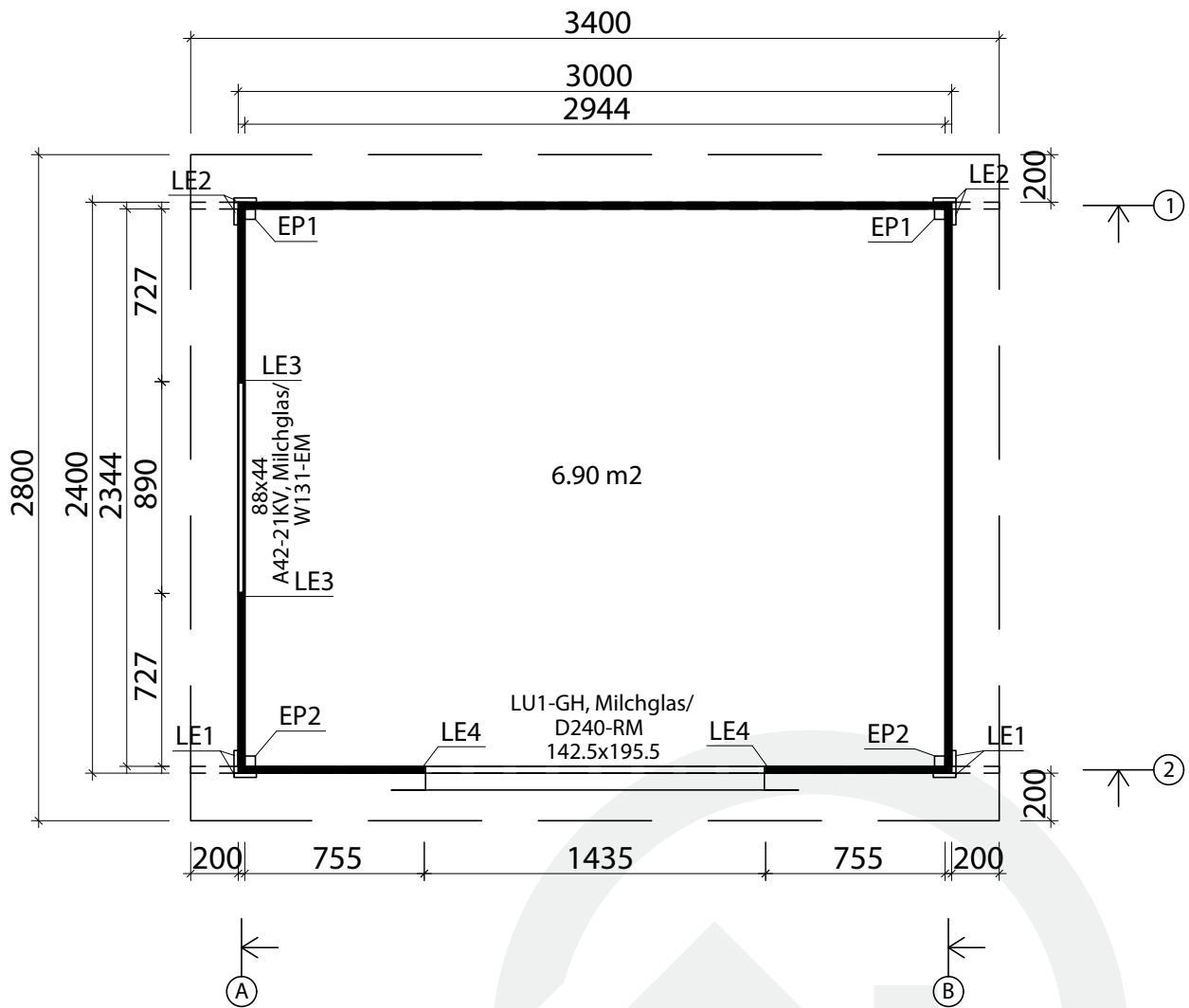

**Q2** - Qualitätsklasse für Fenster und Türen

\* Fenster und Türen sind ohne Sprossen

# Lagerholzplan und Fundamentplan Art.-Nr. 228 310

Wir empfehlen als Fundament für Ihr Gartenhaus eine vollflächig festgegründete, gepflasterte oder betonierte Fläche.  
Wahlweise ist auch ein Punkt- oder Streifenfundament möglich.

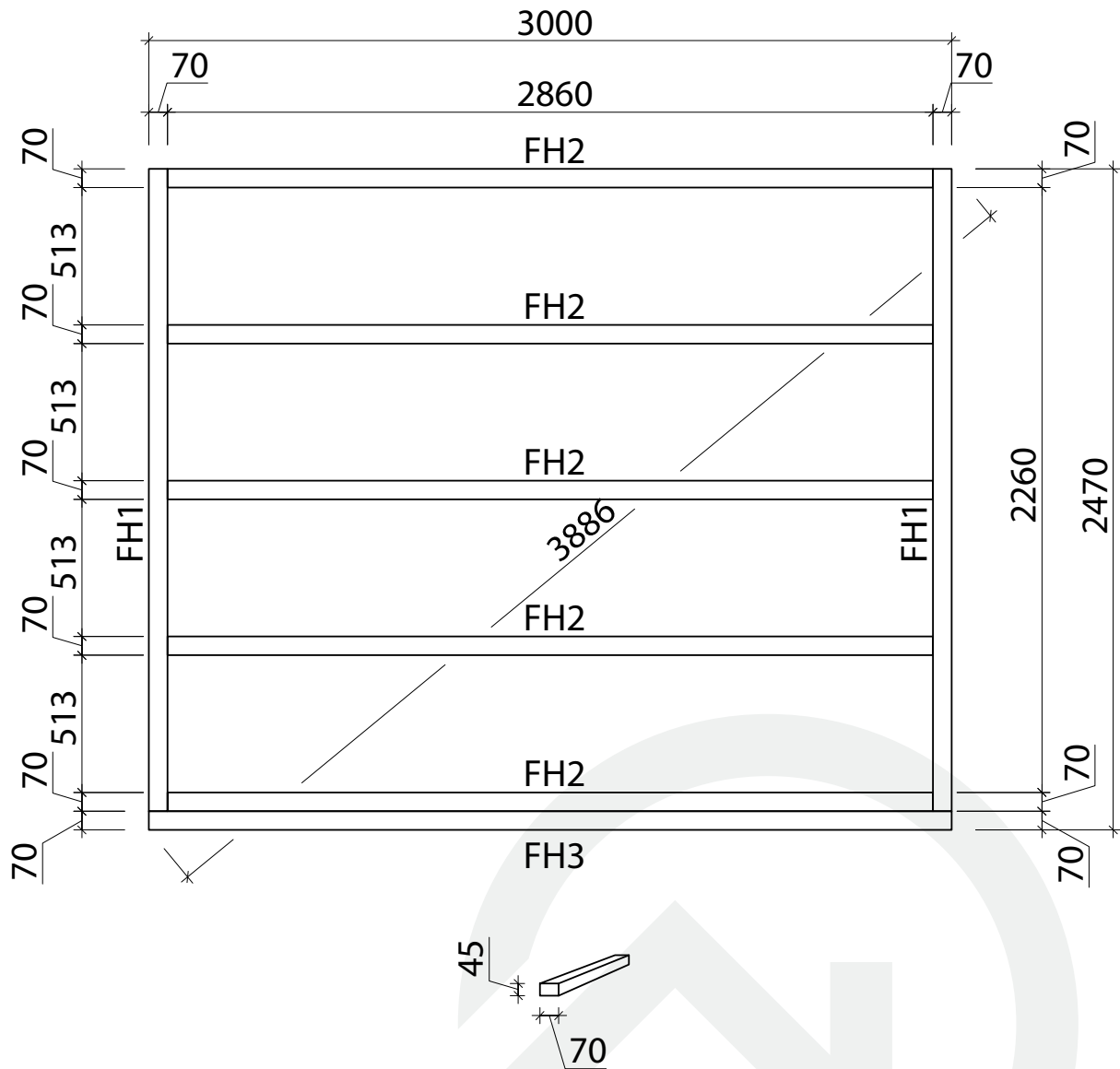













# Teileliste 1

## Art.-Nr. 228 310

Pos		Stck	Profil (mm)	Länge (mm)
001		2	28x114	3400
002		1	28x114	3000
003		19	28x114	3000
005		31	28x114	2344
006		1	28x114	2344
007		34	28x114	768
008		8	28x114	712
WA-1		1		
WB-1		1		
FH3	FUNDAMENTHÖLZER (imprägniert) 	1	70x45	3000
FH2	FUNDAMENTHÖLZER (imprägniert) 	5	70x45	2860
FH1	FUNDAMENTHÖLZER (imprägniert) 	2	70x45	2400
LE1	LEISTE 	4	95x18	2280
LE2	LEISTE 	4	95x18	2166
LE4	LEISTE 	2	15x28	1938
LE3	LEISTE 	2	15x28	446
EP2	ECKPFOSTEN 	2	44x44	2270
EP1	ECKPFOSTEN 	2	44x44	2156
PF1	PFETTEN 	1	44x145	3400
	DACHBRETTER	31+1	113x18	2800
	FUSSBODENBRETTER	27+1	113x18	2340
	FUSSBODENLEISTEN		18x40	11,0 lfm
G02-1	GIEBELBRETTER 18x120	2	18x120	2820
G05-1	GIEBELDECKLEISTEN 18x40	2	18x40	2820
T02-1	TRAUFENBRETTER 18x120	1	18x120	3436

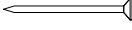
# Teileliste 2

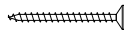
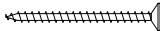
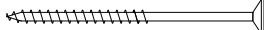
## Art.-Nr. 228 310

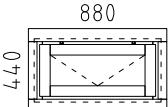
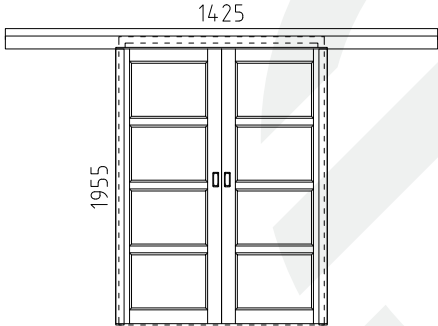
Pos		Stck	Profil (mm)	Länge (mm)
T01-1	TRAUFBRETT 18x95 	1	18x95	3400
T04-1	TRAUFENDECKLEISTEN 18x40 	1	18x40	3436
T06-1	TRAUFENLEISTEN 18x40  ✓		18x40	7,0 lfm
LU-KL-1	LU - Blendleiste 18x95 	1	18x95	3000
LU-OK-1	LU - Endkappen 18x80 	2	18x80	130
LU-KT-1	LU - obere Rahmenteil 44x65 	1	44x65	3000
KP-1	DACHPAPPE  ✓		3,4m-4st.	14,0 lfm
NG01	DACHPAPPNÄGEL 2.8x15 	200		
NG04	NÄGEL 2.5x50 Dachbretter Fussbodenbretter 	456		
SR32	SCHRAUBEN 3.0x30 Fussbodenleiste Traufenleiste, Giebelleiste 40x18 	38		
SR37	SCHRAUBEN 3.5x45 Giebelbretter, Traufenbretter LE1, LE2, LE3, LE4 	194		
SR44	SCHRAUBEN 4.0x60 Wandbohlen zu Eckpfosten 	312		
SR57	SCHRAUBEN 5.0x100 Fundamenthölzer 	32		
SH	Schlaghölzer 	3		
	FENSTER <u>Q2</u> <span style="float: right;">W2-S28E-0XM-08800440</span>  A42-21KV/W131-EM Milchglas	1		
	TÜR <u>Q2</u> <span style="float: right;">D2-Q28R-LLM-14251955</span>  LU1-GH/D240-RM Milchglas	1		
	✓ - bitte selber anpassen (falls nötig)!			

# Wandplan A Art.-Nr. 228 310

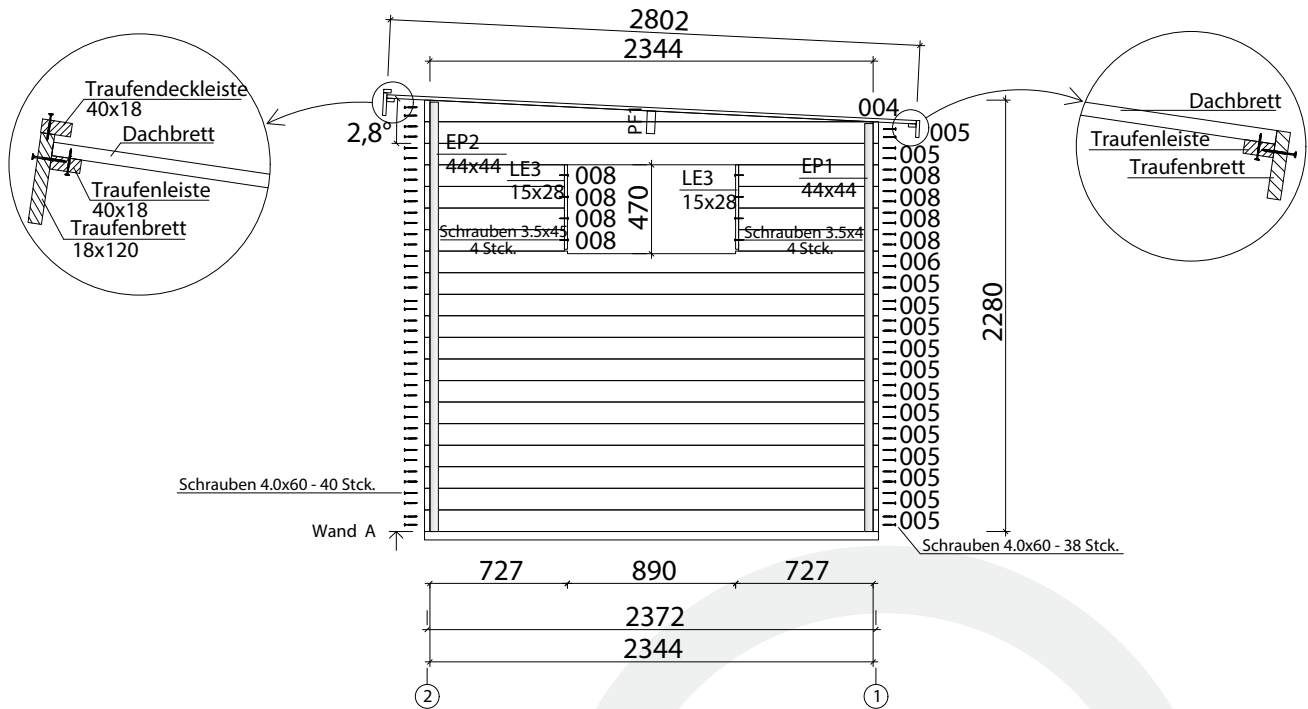



# Wandplan B

## Art.-Nr. 228 310

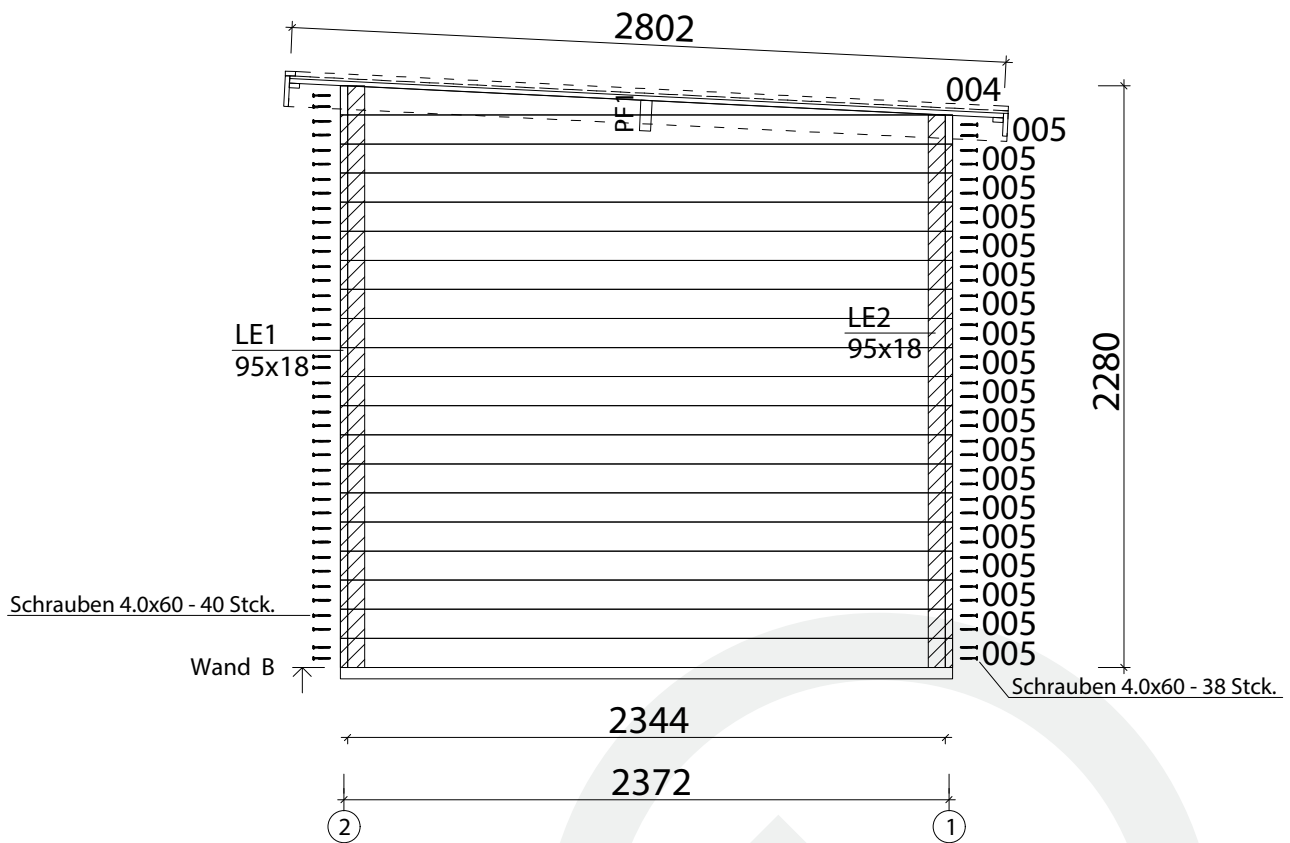

# Wandplan 1

## Art.-Nr. 228 310

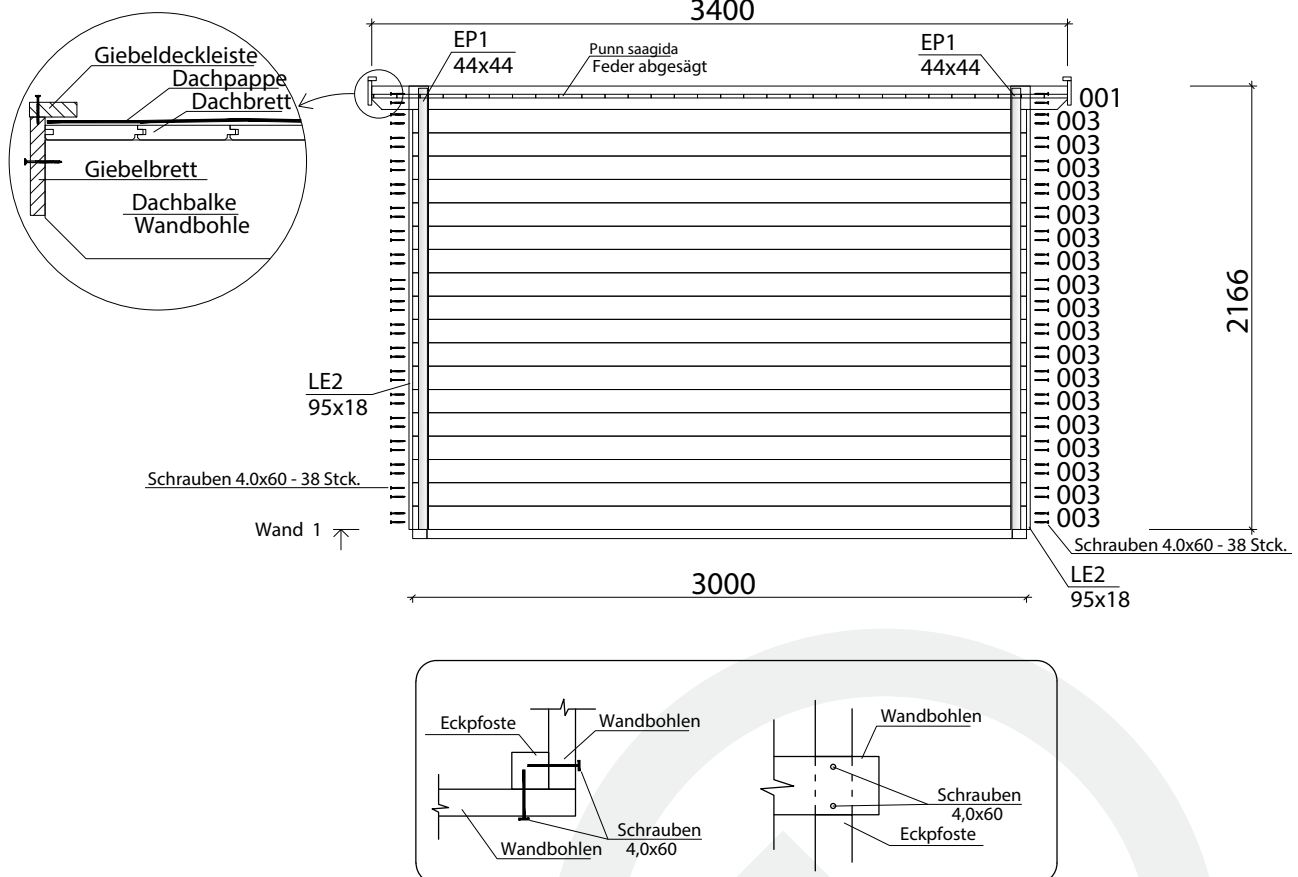

# Wandplan 2

## Art.-Nr. 228 310

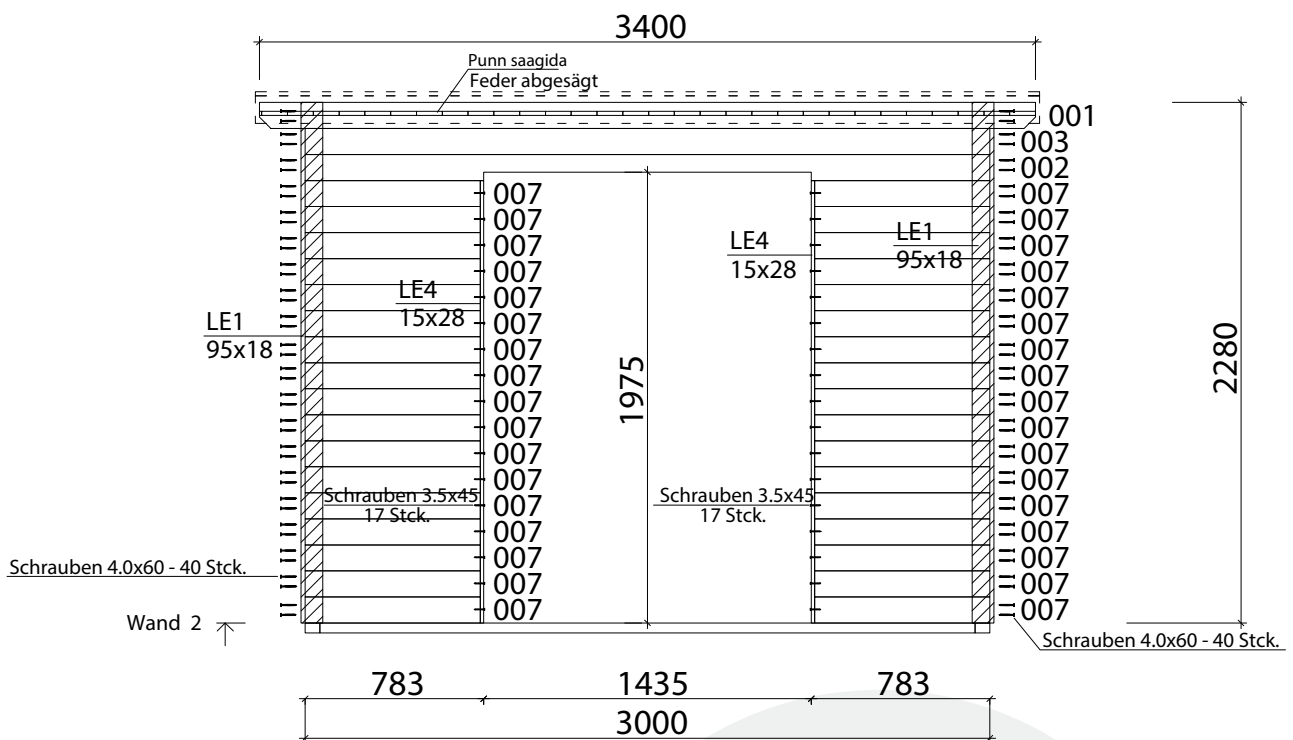

# Türmontage

## Art.-Nr. 228 310

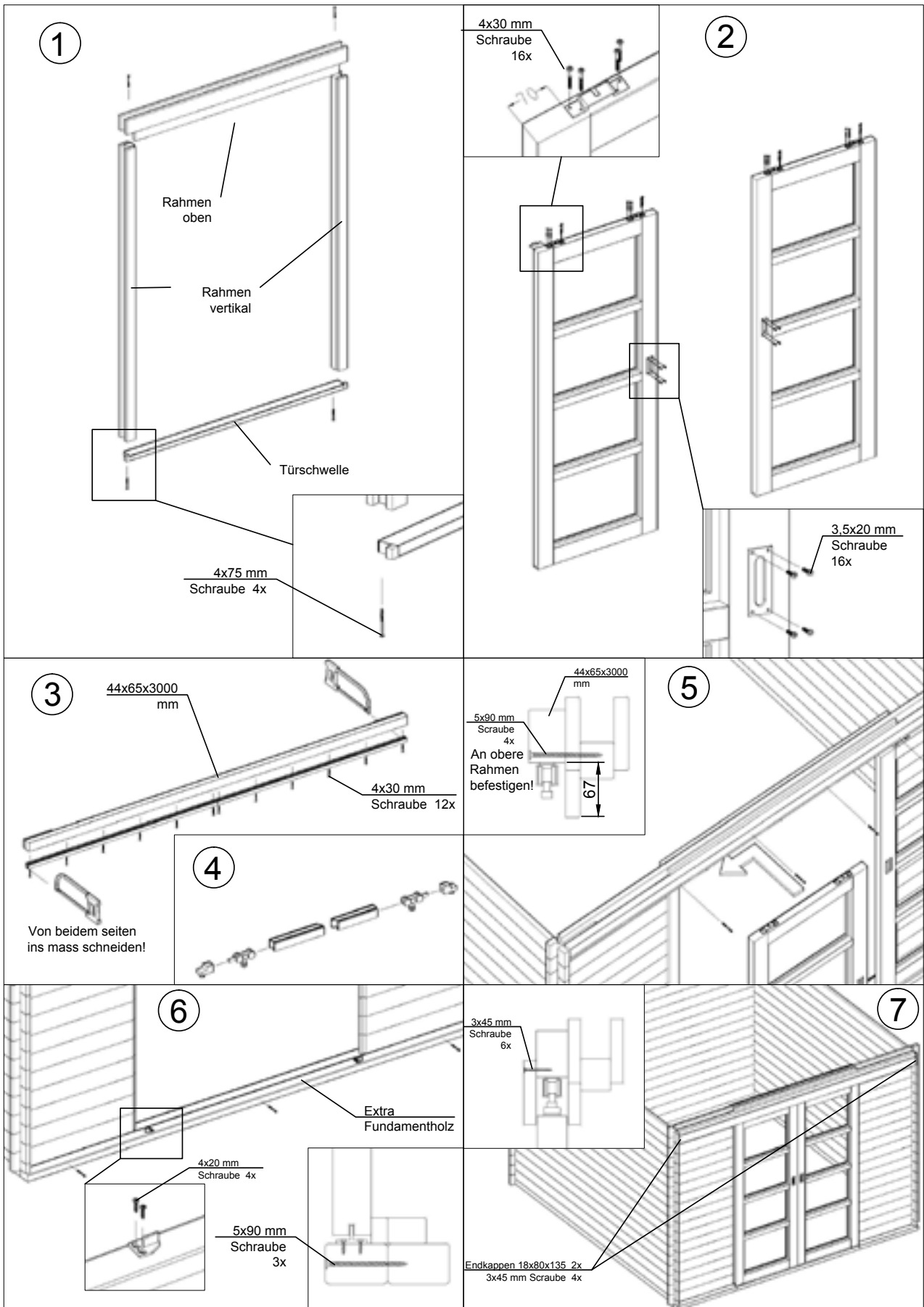

# Technische Daten



Spiegelverkehrte Montage möglich.





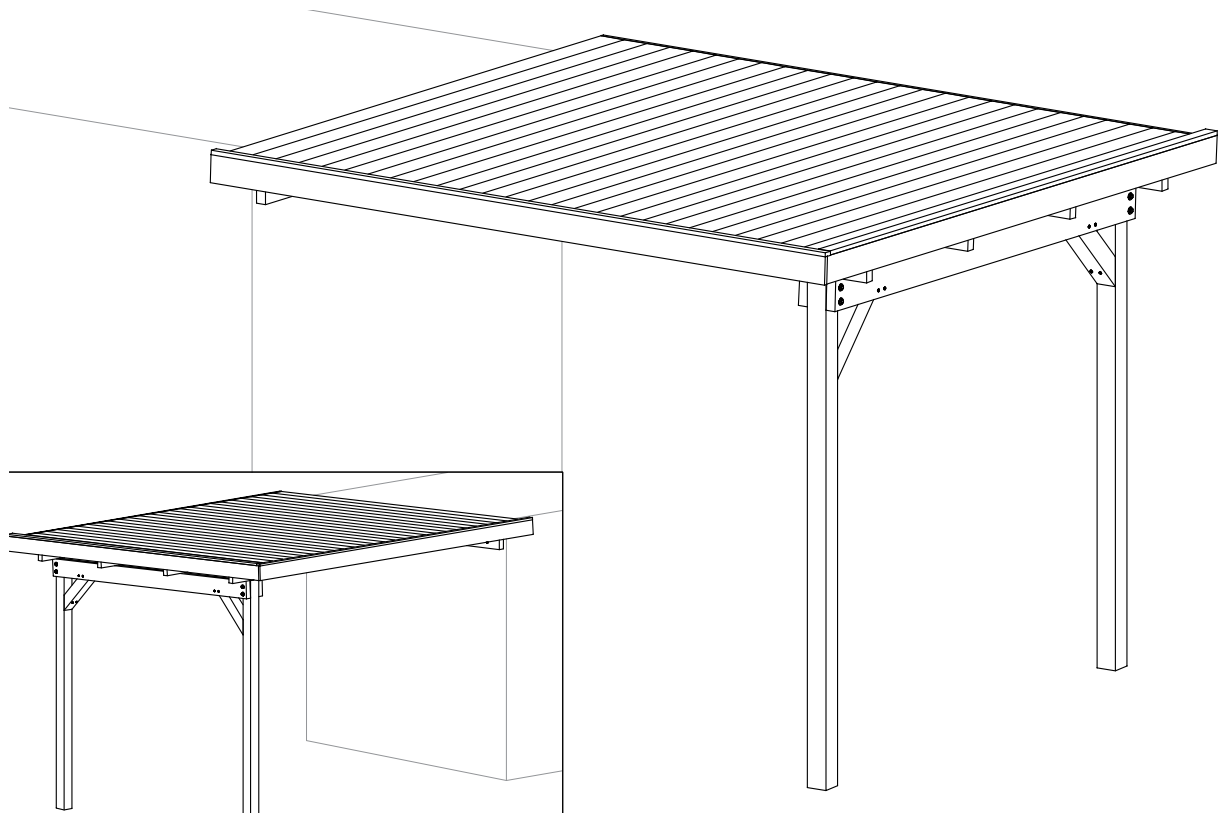



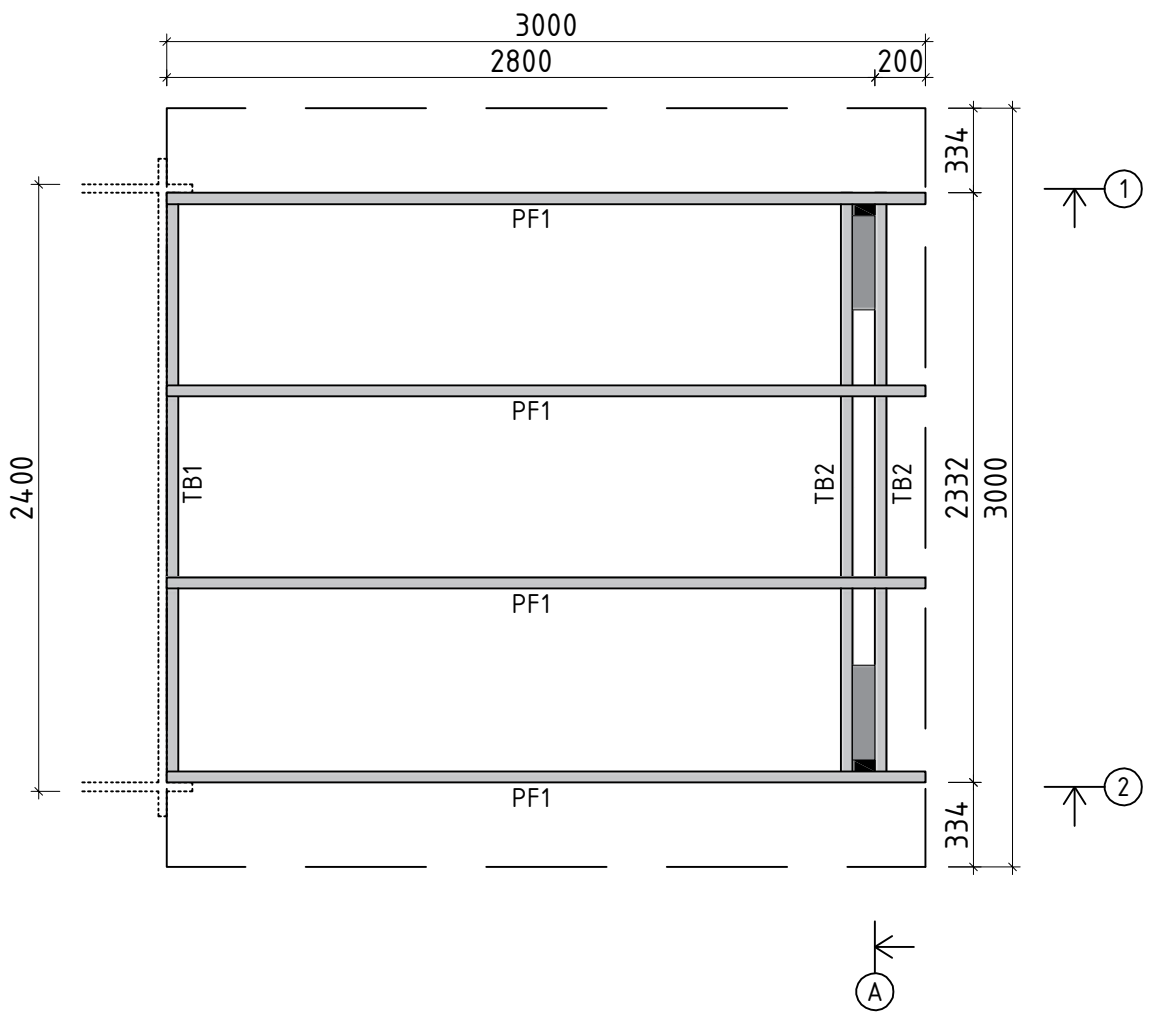

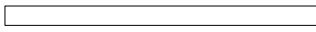

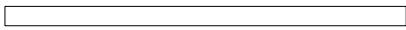



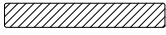

**Artikelnummer:**  
700 220

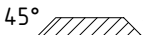
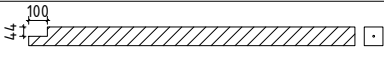
**Kontrolliert durch:**

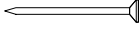

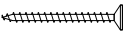
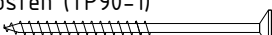
**Wir empfehlen als Fundament für Ihr Gartenhaus eine vollflächig festgegründete, gepflasterte oder betonierte Fläche. Wahlweise ist auch ein Punkt- oder Streifenfundament möglich.**

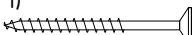
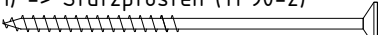

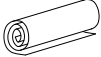
Pos		Stck	Profil (mm)	Länge (mm)
TB2	TRÄGEBALKEN 	2	44x145	2330
TB1	TRÄGEBALKEN 	1	44x94	2330
PF1	PFETTEN 	4	44x145	3000
	DACHBRETTER 	27+1	113x18	3005
G02-1	GIEBELBRETTER 18x120 	1	18x120	3025
G05-1	GIEBELDECKLEISTEN 18x40 	1	18x40	3025
T02-1	TRAUFBRETTER 18x120  ✓	1	18x120	3020
T01-1	TRAUFBRETTER 18x90  ✓	1	18x90	3020
T04-1	TRAUFENDECKLEISTEN 18x40  ✓	1	18x40	3020
T06-1	TRAUFENLEISTEN 18x40  ✓	2	18x40	3020
TP90-1	STÜTZPFOSTEN 90x90  45° 45°	2	90x90	550
TP90-2	STÜTZPFOSTEN 90x90  100 ✓	2	90x90	2310
W01	Winkel 40x40x40 	4		
NG01	DACHPAPPNÄGEL 2.8x15 	200		
NG04	NÄGEL 2.5x50 Dachbretter 	216		
SR32	SCHRAUBEN 3.0x30 Giebeldeckleisten Traufenleisten, Traufendeckleisten 	24		
SR37	SCHRAUBEN 3.5x45 Giebelbretter, Traufenbretter 	18		
SR57	SCHRAUBEN 5.0x100 Trägebalken (TB2) -> Stützpfofen (TP90-1) 	8		
SR51	SCHRAUBEN 5.0x30ÜP Winkel (W01) 	32		
SR55	SCHRAUBEN 5.0x70 Stützpfofen (TP90-2) -> Pfetten (PF1) 	4		
SR61	SCHRAUBEN 6.0x140 Stützpfofen (TP90-1) -> Stützpfofen (TP90-2) 	4		
SS32	Schloßschrauben M8x100 Mutter M8 U-Scheibe Ø25 	9	M8	
SS56	Sechskant Holzschrauben M10x100 U-Scheibe M10 Ø30 	8	M10	
KP-1	DACHPAPPE  ✓		3,3m-4st.	14,0 lfm
	✓ - bitte selber anpassen (falls nötig)!			



