

Technische Daten Reims

Wandaußenmaß: 390 x 300 cm

Bohlenstärke: 28 mm



Kontrolliert durch:

Empty rectangular box for signature or name.

Achtung: Alle angegebenen Maße sind ca.-Maße!

3D-Ansicht Reims

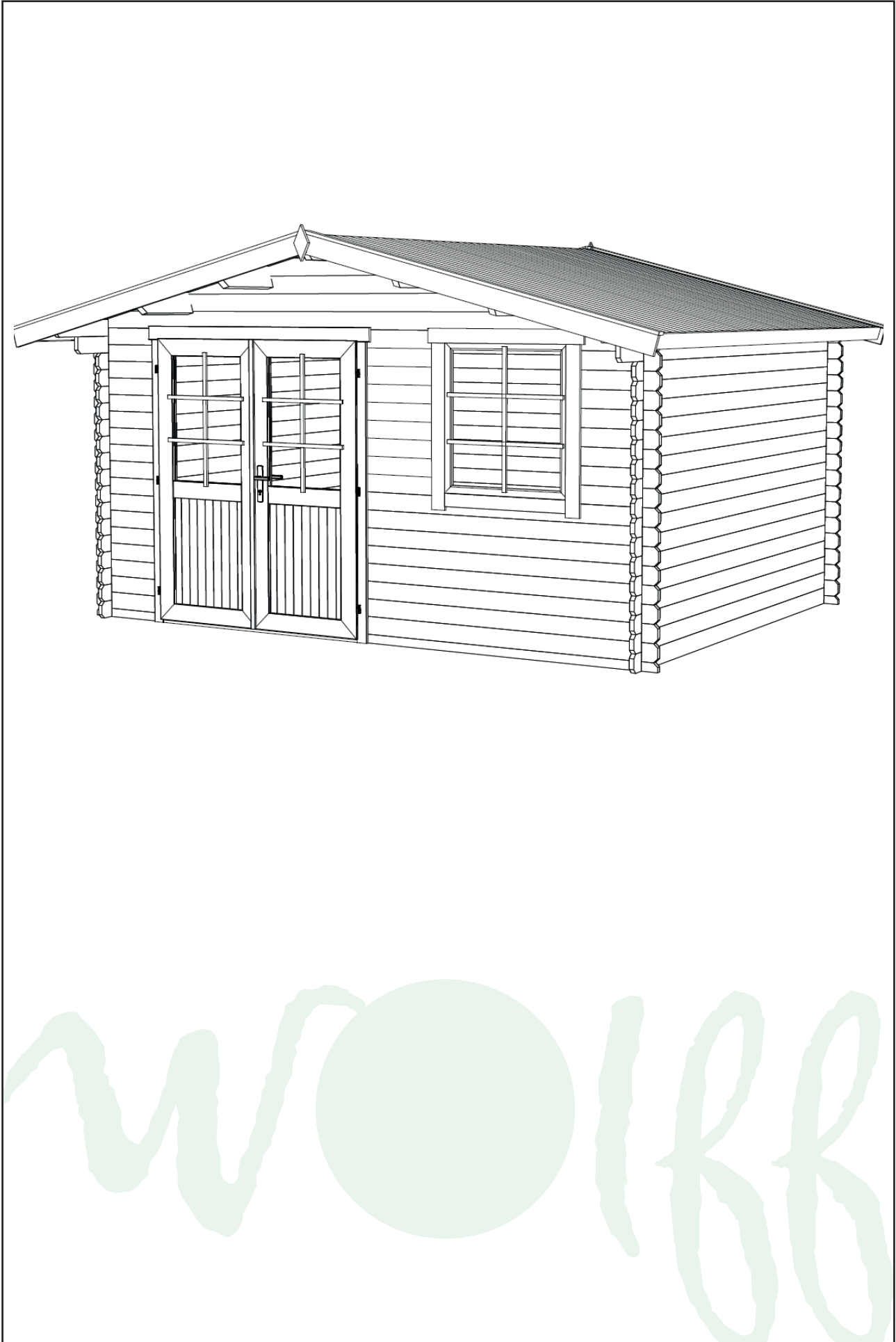

Grundriss Reims

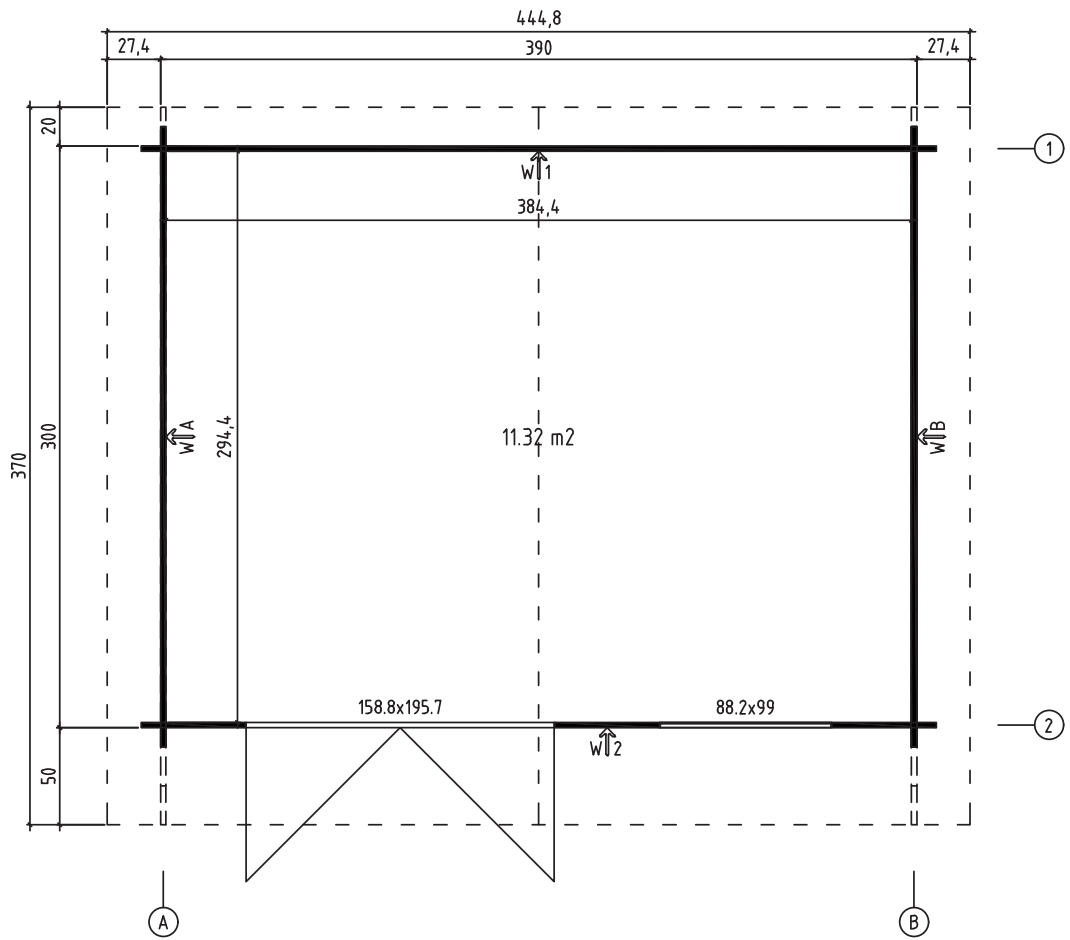





Teileliste 1

Reims

Pos		Q.	P (mm)	L (mm)
001		1	28x57	4100
002		17	28x114	4100
008		1	28x57	537
009		1	28x57	1965
010		26	28x114	537
011		8	28x114	1965
012		9	28x114	537
013		32	28x114	3200
014		2	28x114	3400
015		1	28x120	3700
016		1	28x120	3700
W1-1 W2-1		1 1		
PR21	Roof beam - Dachbalken - Panne de toit - Perlina del tetto - Gordingen / dakbalk - Pärilin 	5	44x140	3700
	Roof boards - Dachbretter - Voliges - Perlina per tetto - Dakhout - Katuselaud	84	90x18	2300
	Roofing felt fillet - Dachpappenleiste - Baguette de fixation du feutre bitumeux Asse per fissaggio guaina bituminosa - Afdekljst asfaltpapier - Katusepapiilist	4	18x58	2350
	Roofing felt (strip) - Dachpappe (bahnen) - Feutre bitumeux (bande) - Cartone catramato - Asfaltpapier (baan) - Katusepapp	5		3800
	Fascia board - Traufbrett - Bandeau de toit - Finitura lati tetto - Gevellijst - Räästalaud	2	18x90	3700
	Roof edge reinforcement - Dachrandverstärkung - Corniere de renfort de bord de toit - Rinforzo x tetto - Dakrand versterking - Räästatugevdus	2	28x34	3700
	Storm protection - Sturmleiste - Latte anti-tempete - Protezione anti vento - Stormverankering / / beveiliging - Tormikinnitusliist	4	22x45	2050
	Gable moulding - Giebelleiste - Planche de rive - Finitura per frontale e retro del tetto - Gevellijst - Viitulaud	4	18x120	2350
	Screw for gable segment - Schrauben für deckblatt - Vis pour fixation losange de finition - Viti x frontali tetto - Schroef voor gevelpunt segment - Kruvi rombile	4	3.5x35	
	Screw for gable - Schrauben für giebel - Vis pour fixation des pignons - Viti per timpano - Schroef voor gevelpunt - Kruvi viilude kinnitamiseks	32	3.5x50	
	Screw for fascia boards - Schrauben für traufbretter - Vis pour fixation fixation bandeau de toit - Viti x striscia del tetto - Schroef voor gevellijst - Kruvi räästalauale	16	4x40	
	Screw for roof edge reinforcement - Schrauben für dachrandverstärkung - Vis pour fixation corniere renfort de bord de toit - Viti x rinforzo bordo tetto - Schroef voor dakrand versterking - Kruvi räästatugevdusele	16	4x40	

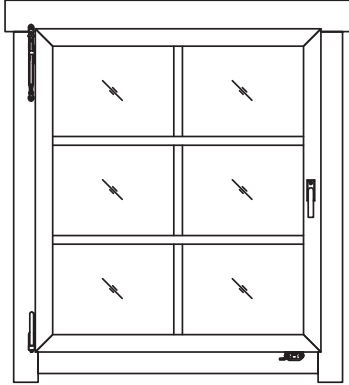
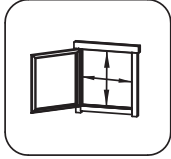







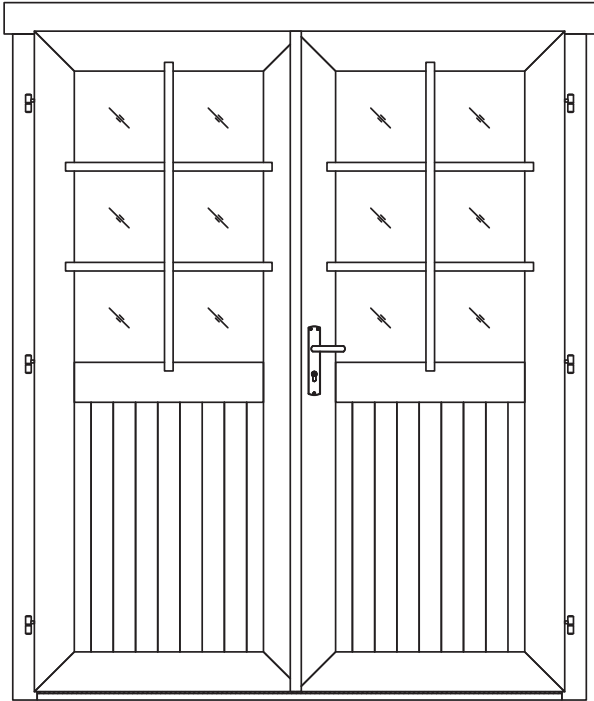
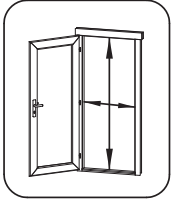

Teileliste 3

Reims

Pos		Q	P (mm)	L (mm)
	<p>Glass size - Glasgröße - Taille de la vitre - Misura del vetro - Glas afmeting - Klaasi mõõt: 738x846 mm</p>   <p>782x890 mm</p>			
FS1	<p>Window handle fittings - Fenstergriff - Poignee de fenetre - Maniglia c/ferramenta - Raamhendel -/grendel -/klink - Aknalink</p> 	1		
FSP	<p>Bolt for window handle fittings - Bolzen für fenstergriff beschlag - Vis pour fixation poignee de fenetre - Bullone x apertura manuale finestra - Schroef voor raamhendel - Akna käepideme polt</p> 	2		
HS1	<p>Screw for georgian bars - Schraube für sprossen - Vis pour croisillons - Viti per unire la griglia georgiana della finestra - Schroeven voor raamverdeling - Kruvi akna peffeliistule</p> 	6	2.5x20	

Teileliste 4

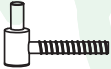
Reims

Pos		Q	P (mm)	L (mm)	
	<p>Glass size - Glasgröße - Taille de la vitre - Misura del vetro - Glas afmeting - Klaasi mõõt: 561x855 mm</p>   <p>1488x1875 mm</p>				
HS1	Screw for georgian bars - Schraube für sprossen - Vis pour croisillons - Viti per unire la griglia georgiana della finestra - Schroeven voor raamverdeling - Kruvi ukse petteliistule		12	2.5x20	
HS4	Screw for door fillet - Schraube zur Befestigung türleiste - Vis pour fixation baguette d'arrêt de porte - Viti per massellino della porta - Schroef voor deurtijst - Kruvi ukse kokkuvalltsiliistule		5	3x30	
HS16	Screw for door jamb - Schraube für Türrahmen - Vis de fixation partie haute avec montants du cadre de porte - Viti x fissaggio montanti porte - Schroef voor deurkozijn - Kruvi ukse lengile		4	5x90	
HS25	Screw for doorstep - Schrauben für swelle - Vis pour fixation barre de seuil - Vite per soglia della porta - Schroef voor deurdorpel - Kruvi lävepakule		3	4.5x65	
TL4	Door handle fittings - Türgriff - Poignée de porte - Maniglie - Deurhendel / klink - Ukse käepide VU		1		
TL5	Set of door lock covers - Schlossblenden - Set de garnitures de porte - Copertura serrature - Slot sluitplaat set - Ukse lukuplaat		1		
	Cylinder lock - Zylinderschloss - Barillet de porte - Serratura - Cylinder slot - Ukse lukusüdamik		1	30x35	
	Male bolt hinge for door - Türband - Partie male de paumelle de porte - Cerniera anube x porta - Scharnier bout - Ukse polthing isane		6		
	Striker for barrel bolt - Hülse für Grendelriegel - Gache au sol du targette - Boccola per fermo della porta - Huls voor vergrendelingsschuif - Vasturaud ukse servariivile		2		

Wandplan 1

Reims

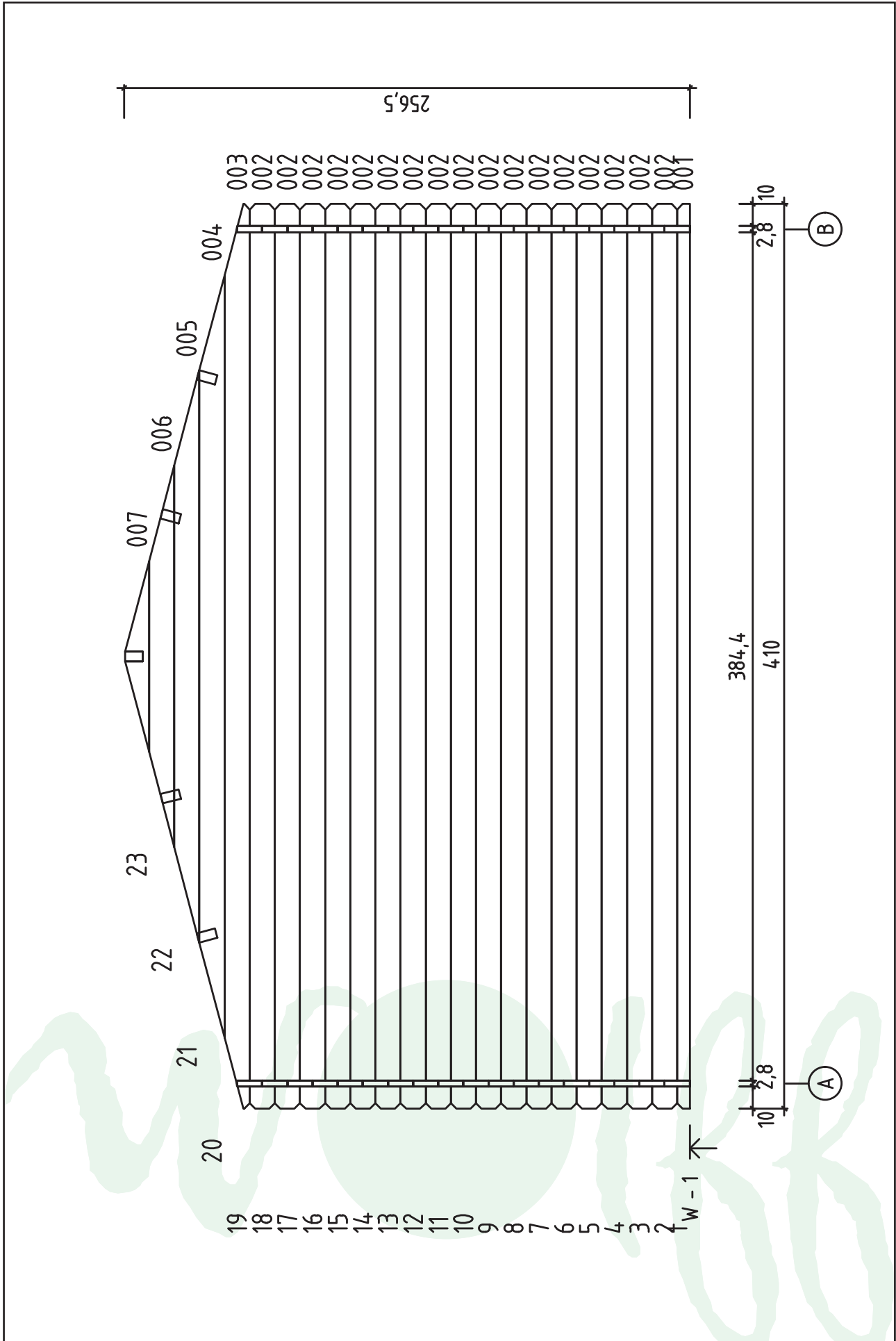

Wandplan B Reims

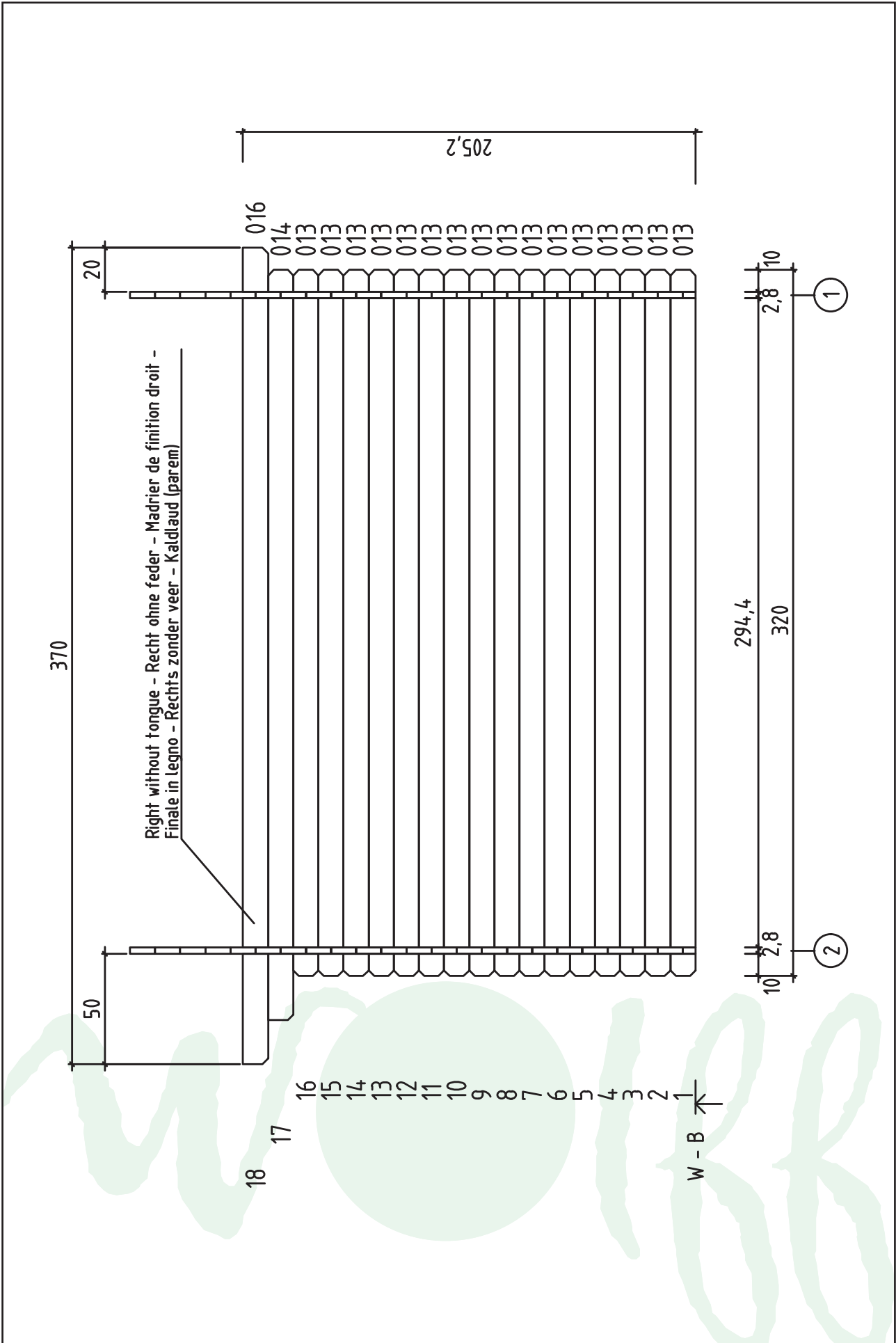

Glasgrößen Reims

Glasgröße - 738x846 mm

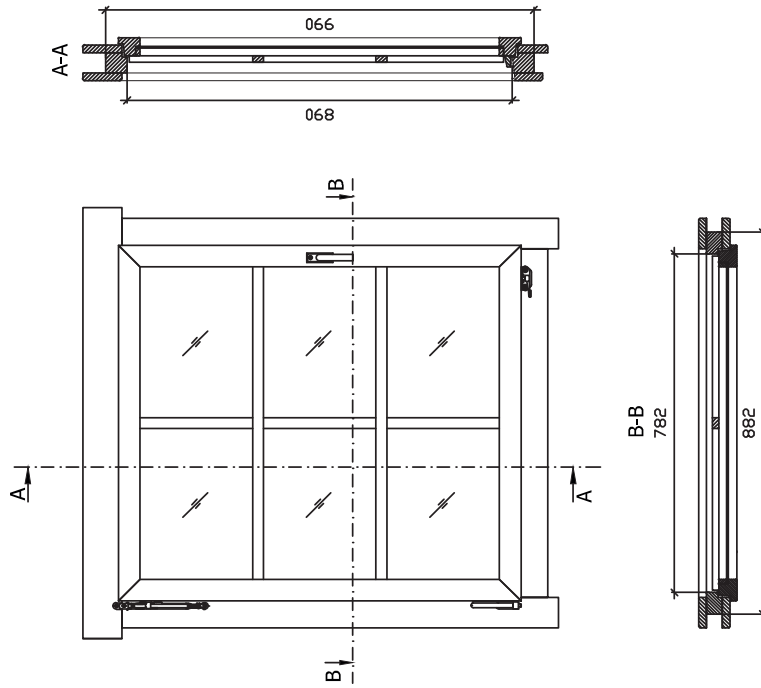

Glasgröße - 561x855 mm

