

Mehr Produkte finden Sie  
in unserem Katalog!









Art. 779 161

# Grillkota 9 de luxe

mit Saunaanbau, Dachschindeln rot-schwarz

45 mm / 376x576 cm / 14,2 m<sup>2</sup>





## DIMENSIONEN

	Bohlenstärke	45 mm
	Innenmaß Saunaanbau	367x317 cm 191x245 cm
	Sockelmaß	376x576 cm
	Gesamtmaß	426x630 cm
	Grundfläche	14,2 m <sup>2</sup>
	Rauminhalt	33,2 m <sup>3</sup>
	Firsthöhe	364 cm
	Seitenwandhöhe	154 cm
	Dachüberstand vorne/seitlich/hinten	29/29/25 cm



## DACH

	Dachneigung	45°
	Dachfläche	20,0 m <sup>2</sup>
	Dachbretter	18 mm

## TÜR/ FENSTER

	Einzeltür (Isoglas)	71x165 cm
	Sauna-Glastür (Sicherheitsglas)	69x189 cm
	Einzelfenster (2 Stück, isolierverglast, Schwing)	82x44 cm
	Dreieckfenster (1 Stück, isolierverglast, feststehend)	97x48 cm

## VERPACKUNG

	Paketabmessung Paket 1/ Paket 2	220/240x120x250 cm
	Paketgewicht	2.000 kg

## ZUBEHÖR (zzgl.)

	<b>Dachrinne</b> Glasdachelement im Tausch Kunststoff 482KA braun Elektroofen 9 KW mit integr. Steuerung Elektroofen 9 KW mit externer Steuerung Bioofen 9 KW mit externer Steuerung <b>Weiteres Zubehör finden Sie im Katalog</b>
--	--

**5 JAHRE  
GARANTIE**

**INKLUSIVE HOCHWERTIGE  
GRILLANLAGE**



Abbildung Grillkota 9 de luxe mit Saunaanbau  
und schwarzen Dachschindeln

## Grundriss

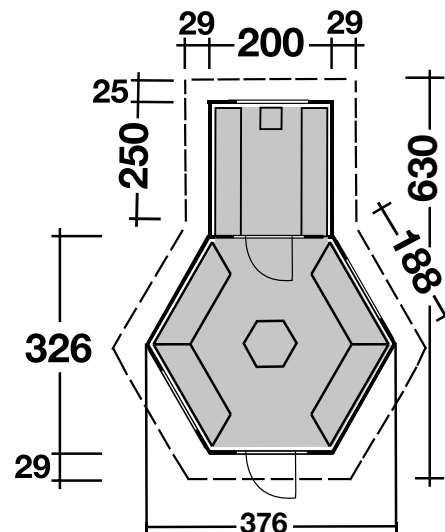

Weitere Informationen finden Sie unter: [www.finnhaus.de](http://www.finnhaus.de) oder im aktuellen Katalog.  
Technische Änderungen, Druckfehler und Irrtümer vorbehalten.