

# Seitendach D

Wandaußenmaß: 300 x 360 cm



Seitendach A

Kontrolliert durch:





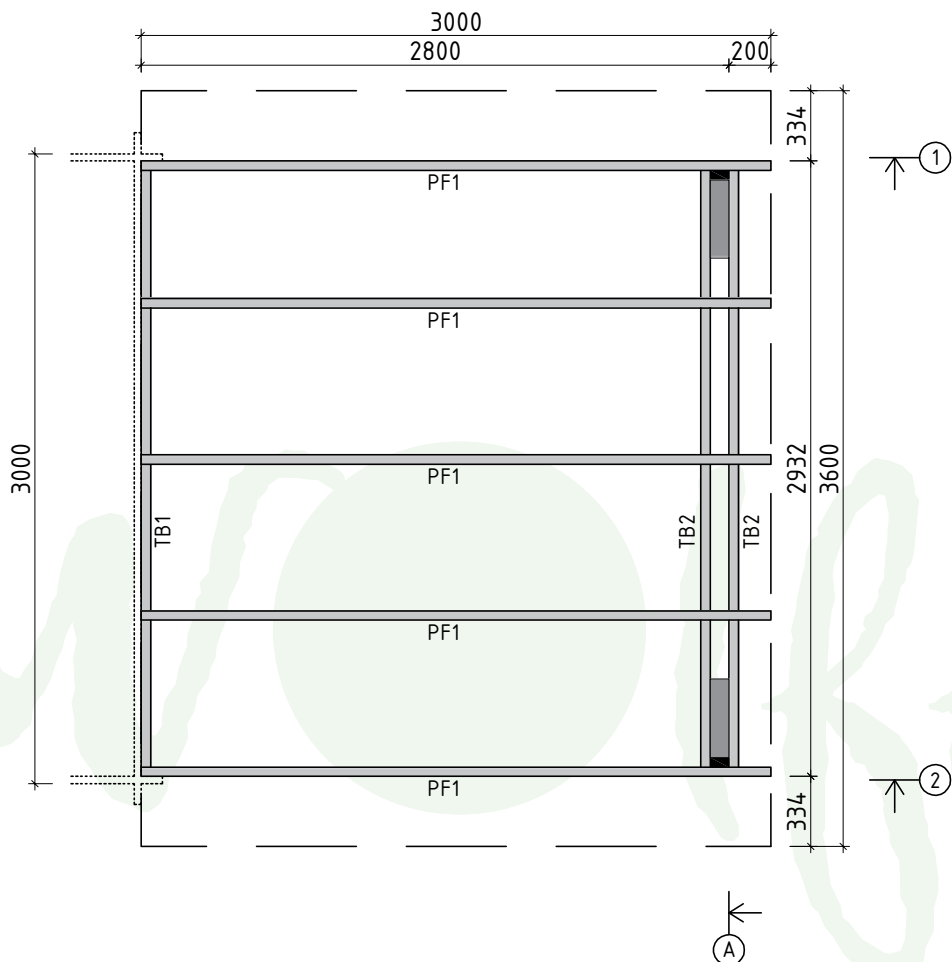
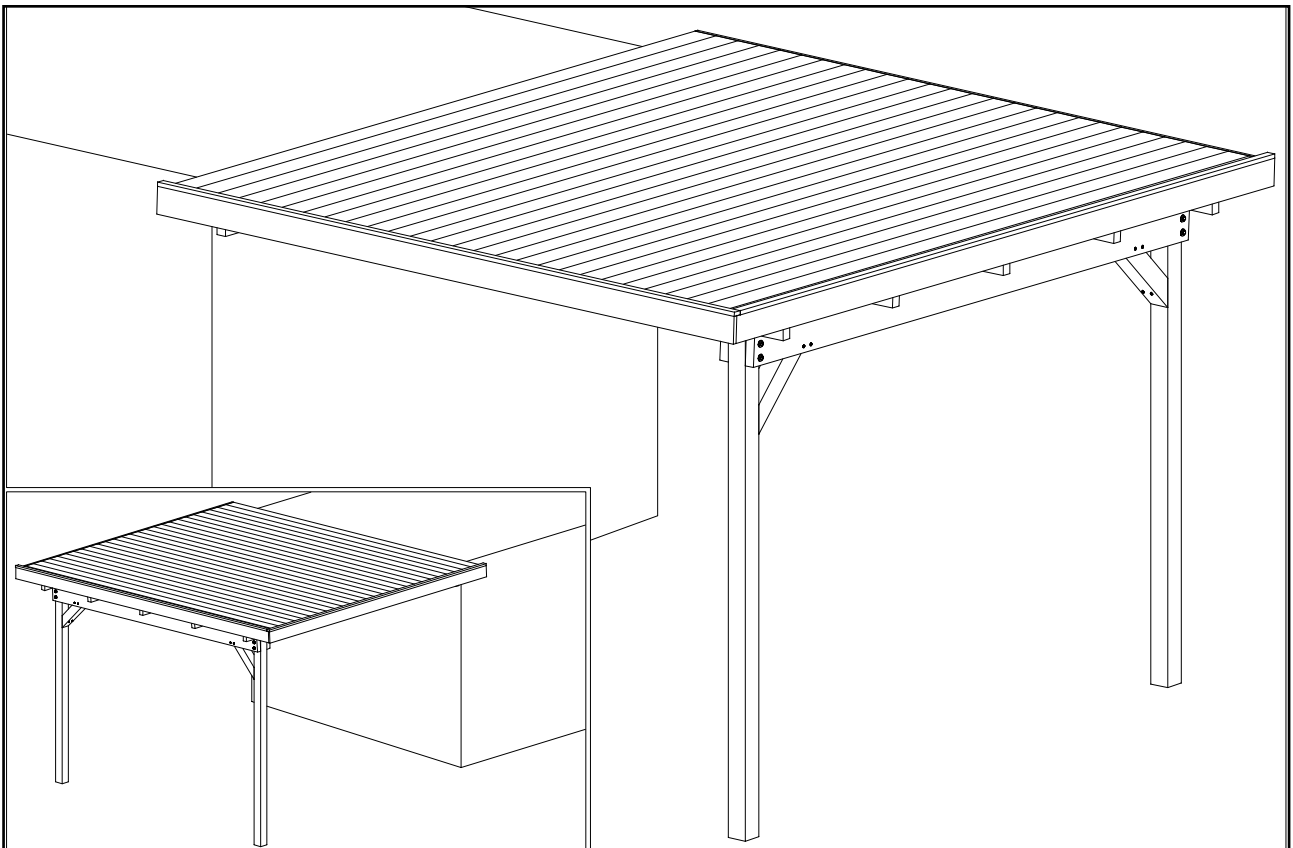





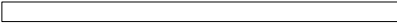







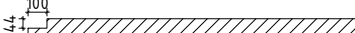

Achtung: Alle angegebenen Maße sind ca.-Maße!

# 3D-Darstellung und Grundriss Seitendach D

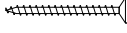
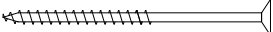

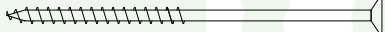
# Teileliste 1

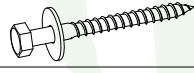
## Seitendach D

Pos		Stck	Profil (mm)	Länge (mm)
TB2	TRÄGEBALKEN 	2	44x145	2930
TB1	TRÄGEBALKEN 	1	44x94	2930
PF1	PFETTEN 	5	44x145	3000
	DACHBRETTER 	27	113x18	3604
G02-1	GIEBELBRETTER 18x120 	1	18x120	3624
G05-1	GIEBELDECKLEISTEN 18x40 	1	18x40	3624
T02-1	TRAUFENBRETTER 18x120  ✓	1	18x120	3020
T01-1	TRAUFENBRETTER 18x90  ✓	1	18x90	3020
T04-1	TRAUFENDECKLEISTEN 18x40  ✓	1	18x40	3020
T06-1	TRAUFENLEISTEN 18x40  ✓	2	18x40	3020
TP90-1	STÜTZPFOSTEN 90x90  45° 45°	2	90x90	550
TP90-2	STÜTZPFOSTEN 90x90  100 44 ✓	2	90x90	2310
W01	Winkel 40x40x40 	6		
NG01	DACHPAPPNÄGEL 2.8x15 	220		
NG04	NÄGEL 2.5x50 	270		
SR32	SCHRAUBEN 3.0x30 	25		
SR37	SCHRAUBEN 3.5x45 	19		
SR57	SCHRAUBEN 5.0x100 	8		
SR51	SCHRAUBEN 5.0x30ÜP 	48		
SR55	SCHRAUBEN 5.0x70 	4		
SR61	SCHRAUBEN 6.0x140 	4		
SS32	Schloßschrauben M8x100 Mutter M8 U-Scheibe Ø25 	10	M8	
SS56	Sechskant Holzschrauben M10x100 U-Scheibe M10 Ø30 	8	M10	
KP-1	DACHPAPPE  ✓		3,3m-4st.	14,0 lfm
	✓ - bitte selber anpassen (falls nötig)!			

# Wandplan 1 und 2 Seitendach D

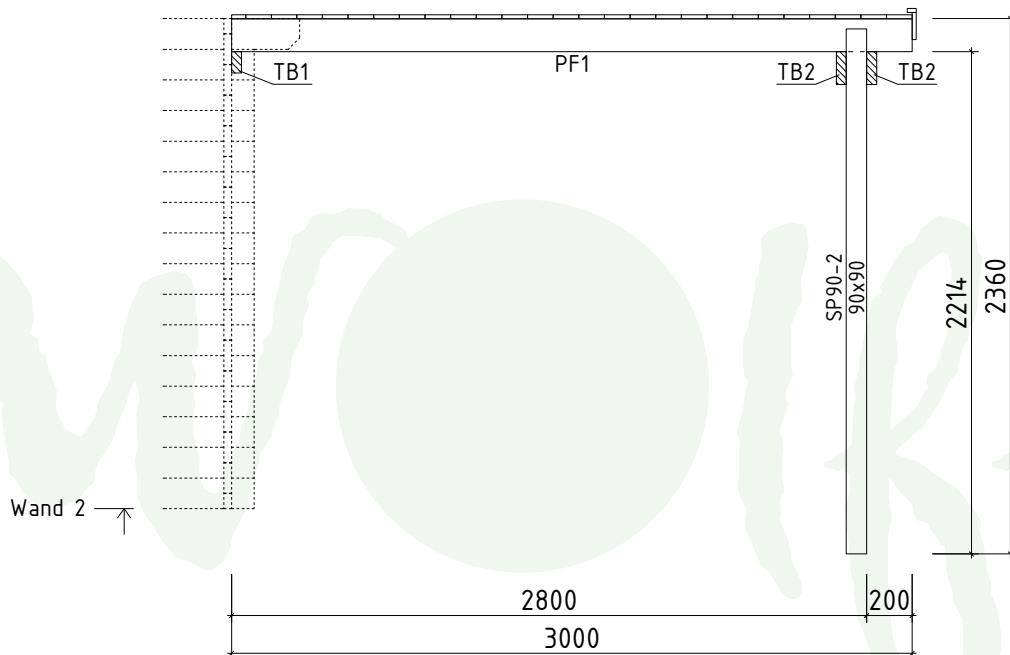
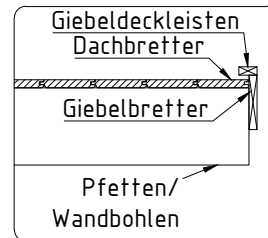
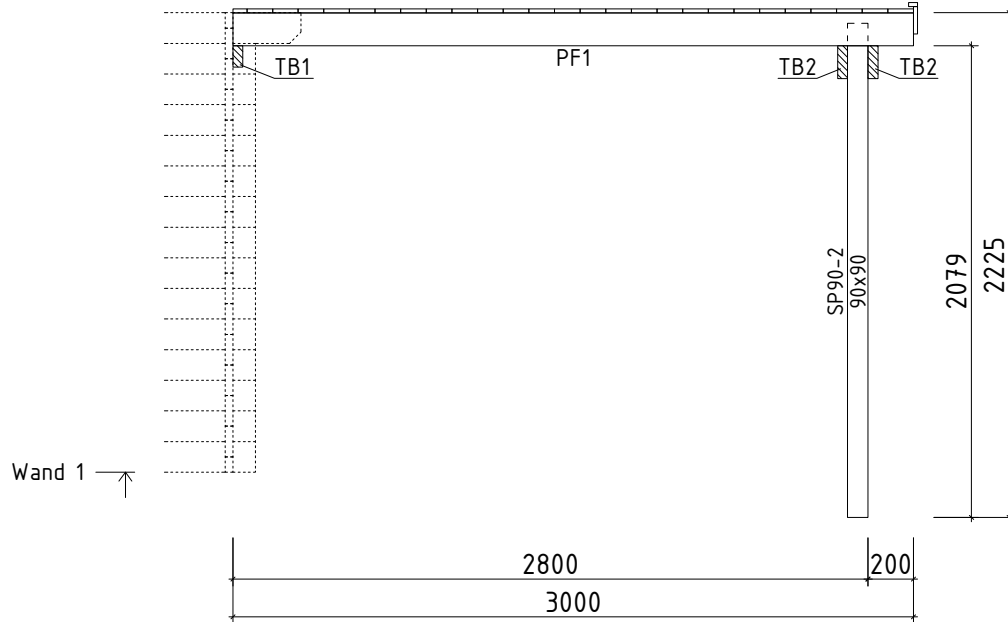

# Wandplan A Seitendach D

