

Mehr Produkte finden Sie  
in unserem Katalog!

Art. 680 360

# WPC-Trend D







WPC-Hohlkammerprofil

28 mm / 287x287 cm / 8,2 m<sup>2</sup>



**5** JAHRE  
GARANTIE

witterungsbeständige  
Dacheindeckung  
erforderlich

## DIMENSIONEN

	Bohlenstärke	28 mm
	Innenmaß	281x281 cm
	Sockelmaß	287x287 cm
	Gesamtmaß	340x332 cm
	Grundfläche	8,2 m <sup>2</sup>
	Rauminhalt	16,8 m <sup>3</sup>
	Seitenwandhöhe vorne/hinten	221/204 cm
	Dachüberstand vorne seitlich hinten	22,5 cm 26,5 cm 22,5 cm
	Wandpaneele	28x160 mm

## DACH

	Dachneigung	3°
	Dachfläche	11,3 m <sup>2</sup>



## TÜR

	Alu-Doppeltür (Milchglas)	138x189 cm
--	---------------------------	------------

## FENSTER

	Fenster	ca. 50,5x90,0 cm
		1 Stück, Normalglas, Ausstell

## VERPACKUNG

	Paketabmessung	324x112x70 cm
	Paketgewicht	900 kg

## ZUBEHÖR (zzgl.)

	Fußboden-Set 3 x Dichtungsbahn-Rollen (je 5 x 1 m) Bodenschwelle/Rampe <b>Dachrinne</b> Kunststoffrinne WPC D Alu bis 400 mit 1 Fallrohr
--	---



## Grundriss

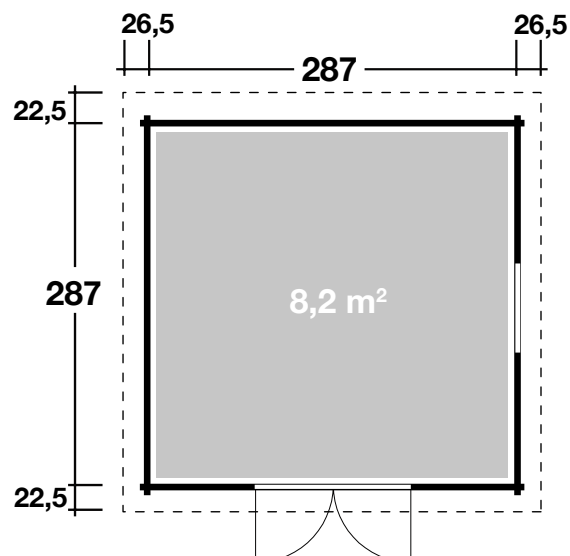

Weitere Informationen finden Sie unter: [www.finnhaus.de](http://www.finnhaus.de) oder im aktuellen Katalog.  
Technische Änderungen, Druckfehler und Irrtümer vorbehalten.