

Technische Daten: Art.-Nr.: 660007

Wandaußenmaß: 287 x 287 cm
Bohlenstärke: 21 mm



Kontrolliert durch:

Empty box for signature or name.

Achtung: Alle angegebenen Maße sind ca.-Maße!

Grundriss Lagerholzplan 660007

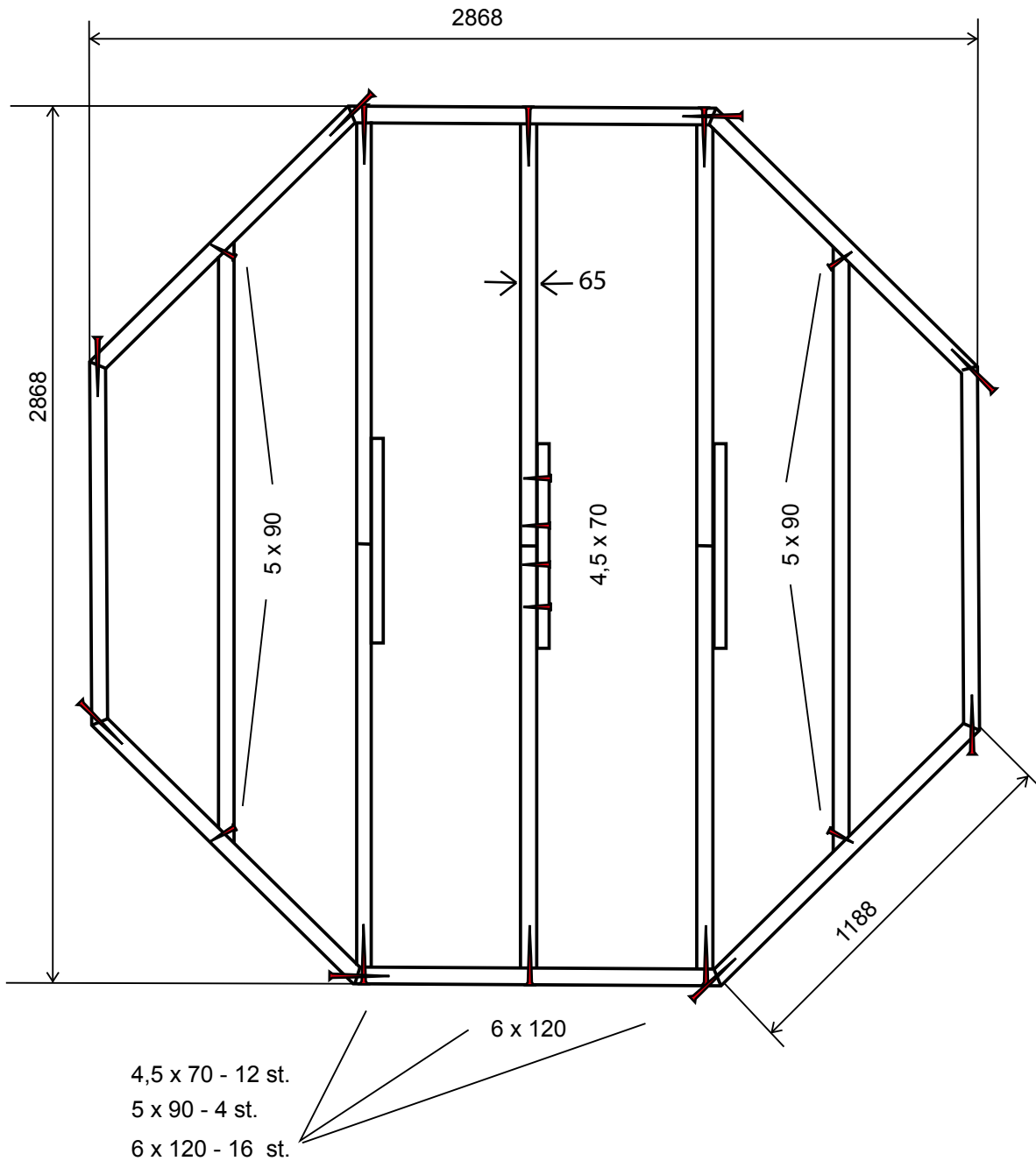

Fussbodenbretter

660007

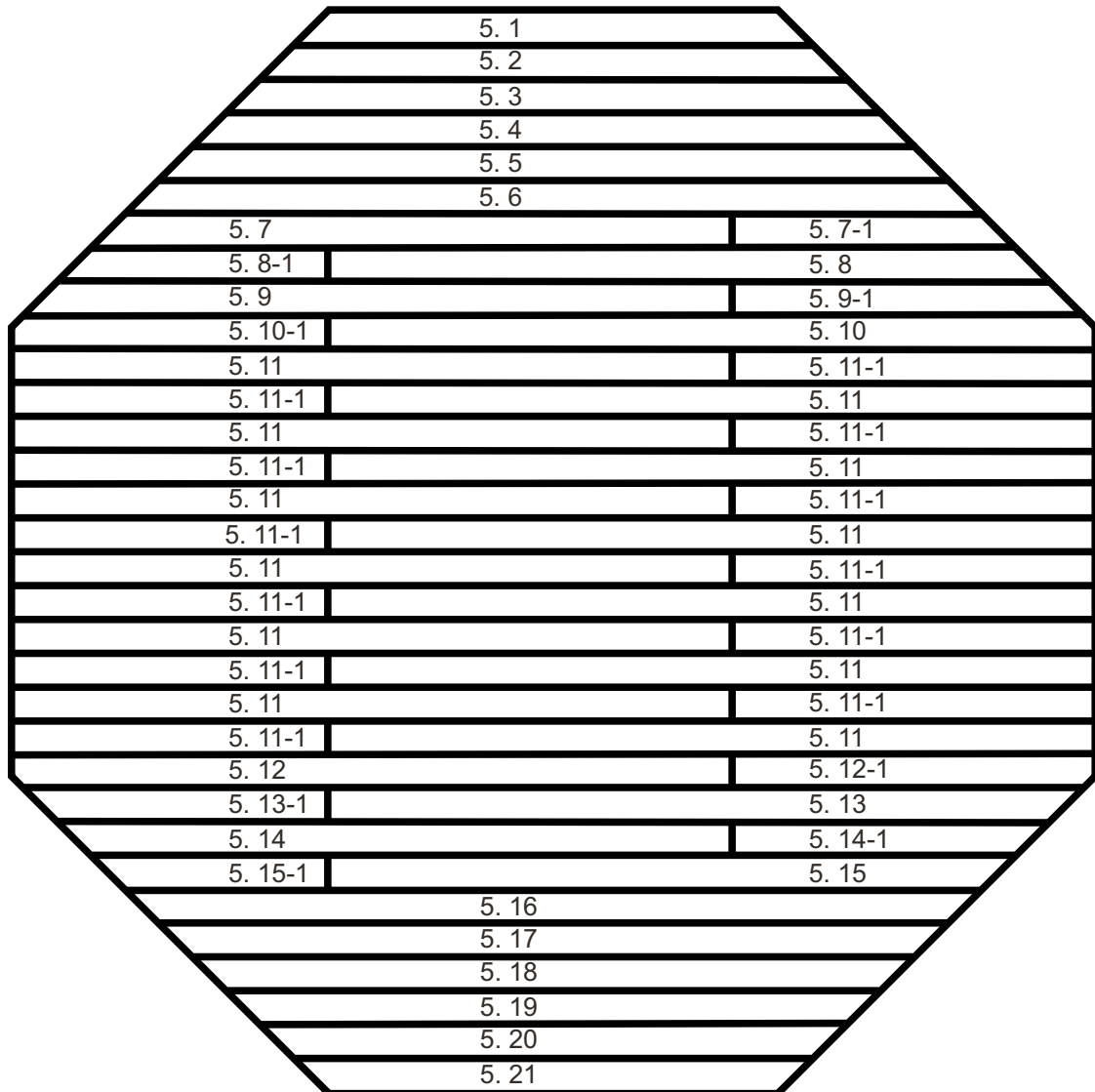

5.1= 1350
5.2= 1525
5.3= 1699
5.4= 1870
5.5= 2045
5.6= 2220

5.7 =1730
5.7-1 =660
5.8 =1815
5.8-1 =755
5.9 =1905
5.9-1 =840
5.10 =1905
5.10-1=840
5.11 =1965
5.11-1= 903
5.12 = 1905
5.12-1= 840
5.13 = 1905
5.13-1= 840
5.14 = 1815
5.14-1= 755
5.15 = 1730
5.15-1= 660

5.16 =2220
5.17 =2045
5.18 =1870
5.19 =1699
5.20 =1525
5.21 =1350

Fundamentplan 660007



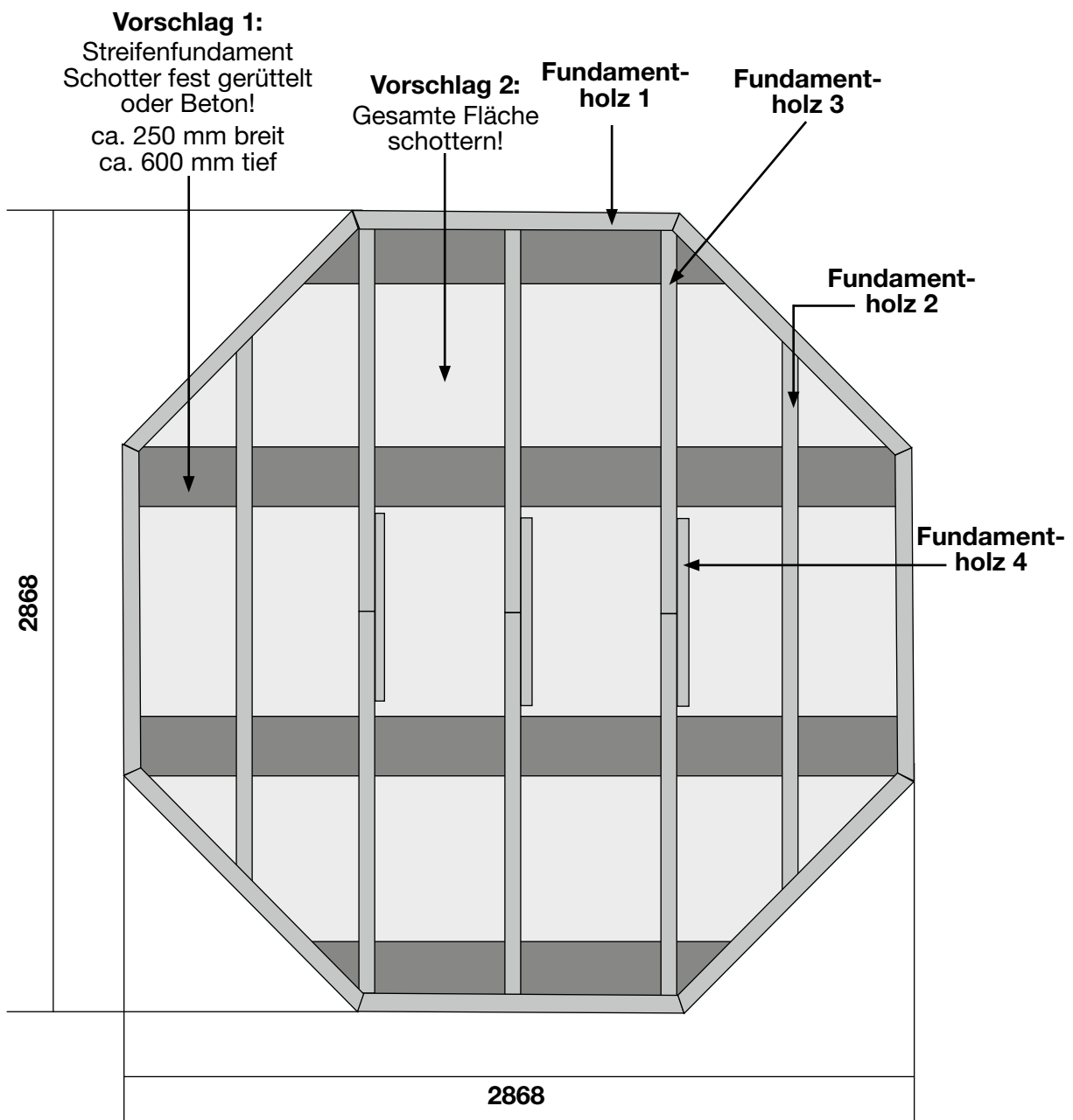

























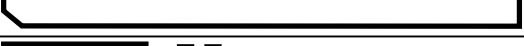

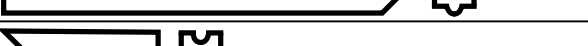





Haustyp	Anzahl der Fundamenthölzer (B x H x L)
Palma	Fundamentholz 1: 8 (45 x 65 x 1188 mm) Fundamentholz 2: 2 (45 x 65 x 1990 mm) Fundamentholz 3: 6 (45 x 65 x 1369 mm) Fundamentholz 4: 3 (45 x 45 x 600 mm)

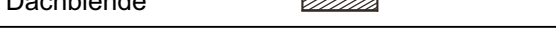

Dieser Fundamentplan ist ein unverbindlicher Vorschlag und kann individuell verändert werden!

Teileliste 1

660007

	Stückliste	pcs	Profil (mm)	Länge (mm)
1	Fundament 	8	45 x 65	1188
2	Fundament 	2	45 x 65	1990
3	Fundament 	6	45 x 65	1369
4	Fundament 	3	45 x 45	600
5	Fussbodenbrett 			
5.1		1	21 x 90	1350
5.2		1	21 x 90	1525
5.3		1	21 x 90	1699
5.4		1	21 x 90	1870
5.5		1	21 x 90	2045
5.6		1	21 x 90	2220
5.7		1	21 x 90	1730
5.7-1		1	21 x 90	660
5.8		1	21 x 90	1815
5.8-1		1	21 x 90	755
5.9		1	21 x 90	1905
5.9-1		1	21 x 90	840
5.10		1	21 x 90	1905
5.10-1		1	21 x 90	840
5.11		13	21 x 90	1965
5.11-1		13	21 x 90	903
5.12		1	21 x 90	1905
5.12-1		1	21 x 90	840
5.13		1	21 x 90	1905
5.13-1		1	21 x 90	840
5.14		1	21 x 90	1815
5.14-1		1	21 x 90	755
5.15		1	21 x 90	1730
5.15-1		1	21 x 90	660
5.16		1	21 x 90	2220
5.17		1	21 x 90	2045
5.18		1	21 x 90	1870
5.19		1	21 x 90	1699
5.20		1	21 x 90	1525
5.21		1	21 x 90	1350
6	Abdeckleiste 	16	16 x 78	2086
7	Dachstützleiste 	8	16 x 90	1076
8	Dachblende 	8	16 x 90	1478





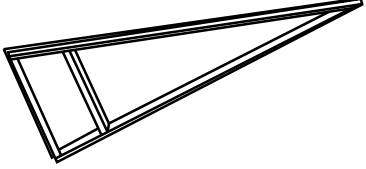
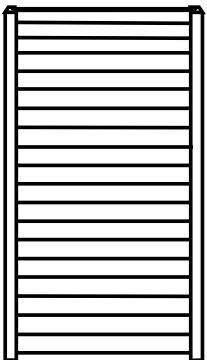
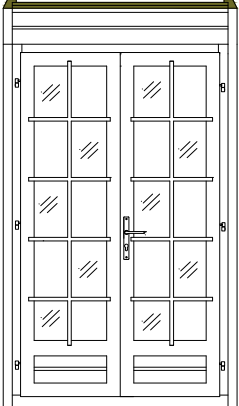
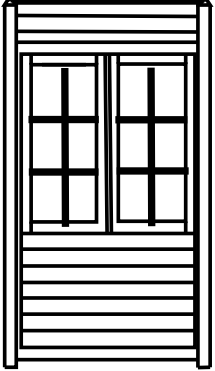









Teileliste 2

660007

	Stückliste	Stk.	Profil (mm)	Länge (mm)
9	Dachelement 	8	62 x 1441	1188
10	Wandelement 	5/3	55 x 1211	2095
11	Türelement 	1	55 x 1211	2095
12	Fensterelement 	2/4	55 x 1211	2035

Teileliste 3

660007

	Stückliste		Stk.	Profil (mm)	Länge (mm)
13	Befestigungsmaterial 		1		
14	Zylinderschloss 		1		
15	Türbeschlag 		1		
16	Fenstergriff 		2		
17	Schraube 3x 25 		2		
18	Schraube 3 x 35 		176		
19	Schraube 4,5 x 70 		12		
20	Schraube 5 x 90 		60		
21	Schraube 6 x 120 		14		
22	Nagel 2,5 x 50 		300		
23	Fensterfeststeller 		2/4		
24	Dachpappnagel 2,5 x 20 		400		
25	Schraube 5 x 80 		24		
26	Schraube 		4		

Türdetail 660007

M 1:8

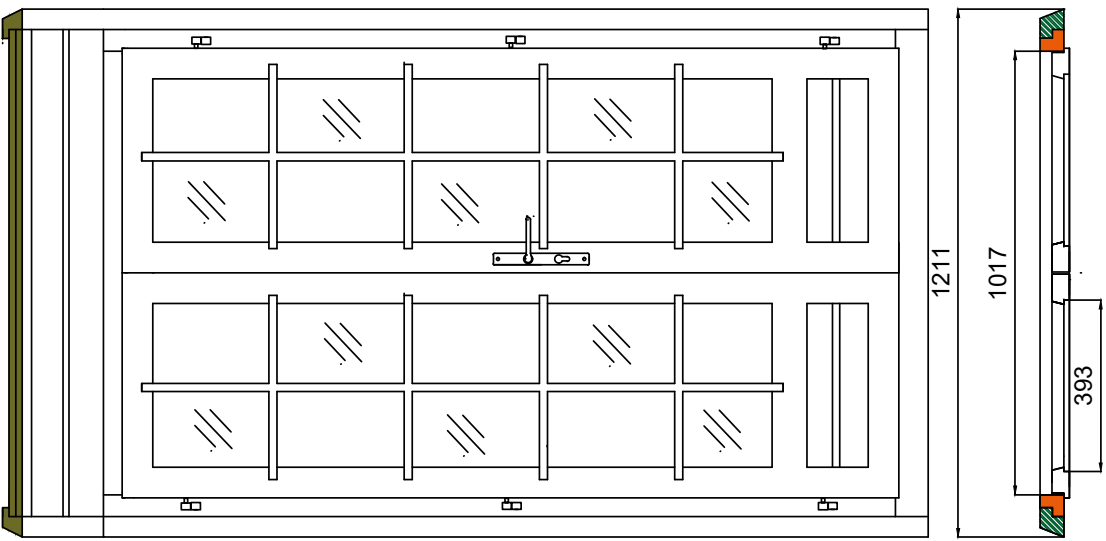
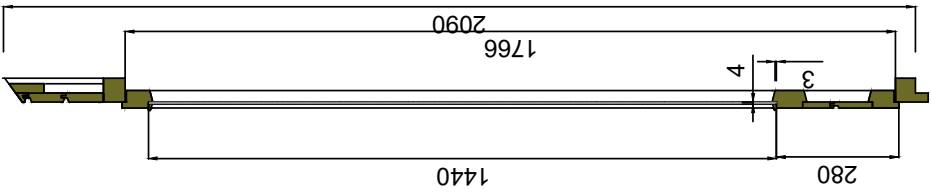
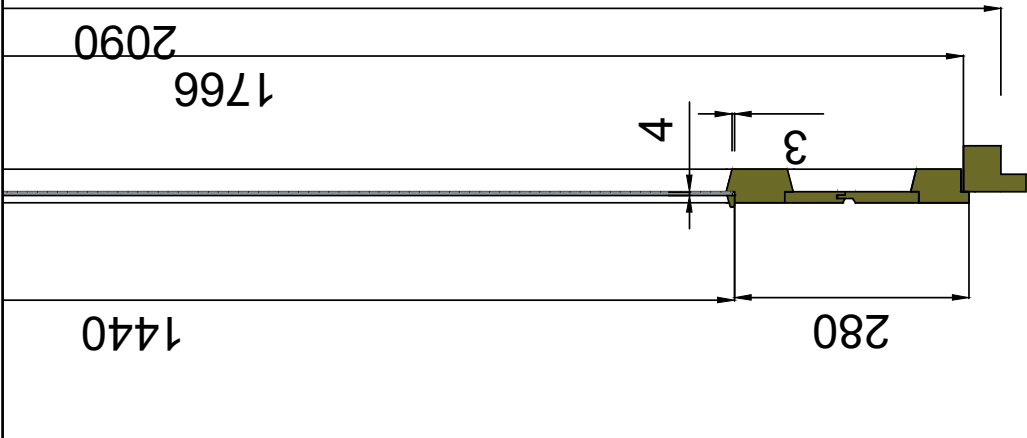

M 1:16