

93389 93390

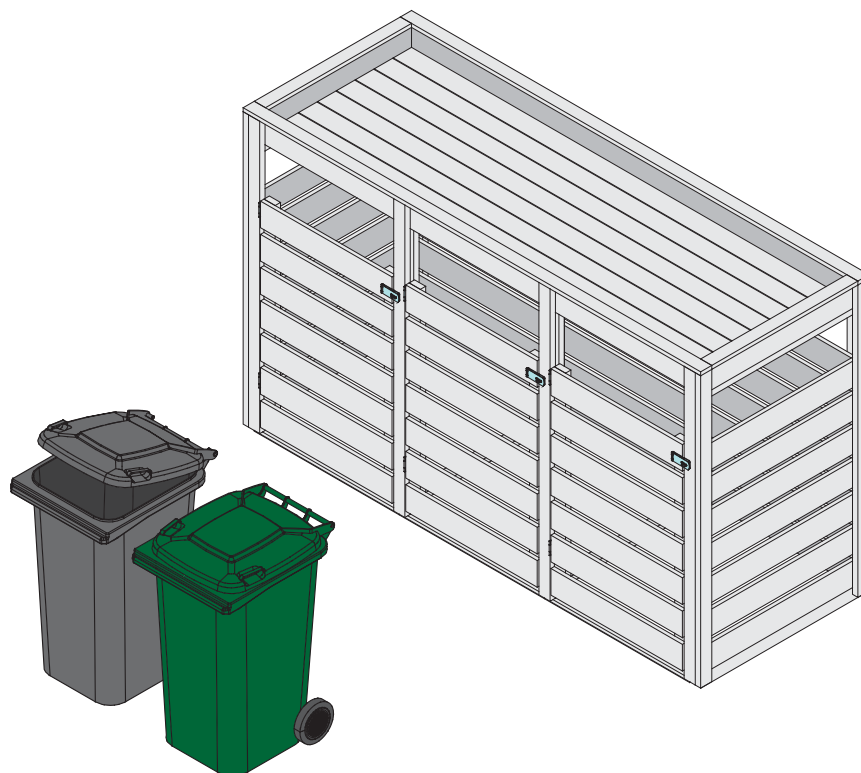

Das komplette
Farbangebot
finden Sie auf:



[www.KARIBU-
FARBESHOP.de](http://www.KARIBU-FARBESHOP.de)

-  **Aufbauanleitung**
-  **Building Instructions**
-  **notice de montage**
-  **montagehandleiding**
-  **Montagevejledning**
-  **Instrucciones de construcción**
-  **Istruzioni per il montaggio**
-  **Montážní návod**





Bitte bewahren Sie die Anleitung und den Garantieschein zur Seriennummer auf.





Vernichten Sie diese erst nach Ablauf der Garantiezeit.





Eventuelle Beanstandungen können mithilfe der Stückliste einfacher zugeordnet werden.





Beigelegte Dokumente

- Informationsheft
- Garantieschein zur Seriennummer
- Typenschild inkl. Warnhinweise (Sauna)
- ggf. Zubehör-Anleitungen in externen Paketen





- *  Nicht im Lieferumfang enthalten
 Not included
 Non comprises dans la livraison
 Niet bijgeleverd

-  No forman parte del suministro
 Non incluso
 V ceně není zahrnuto
 Ikke inkluderet

- 1  Länge muss ermittelt und zugesägt werden
 Length must be determined and sawn
 La longueur doit être déterminée et sciée
 De lengte moet worden bepaald en worden gezaagd

-  La longitud debe ser determinada y aserrada
 La lunghezza deve essere determinata e segata
 Délka musí být určena a rozřezána
 Længden skal bestemmes og savnes





- 2  Nicht gebraucht
 Not needed
 Pas nécessaire
 Niet nodig

-  No es necesario
 Non necessario
 Není nutná
 Ikke nødvendigt





- 3  Mit Zubehör
 With accessories
 Avec accessoires
 Met toebehoren

-  Con accesorios
 Con accessori
 S příslušenstvím
 Med tilbehør

- 4  Fixiert vorübergehend
 Fixed temporarily
 Temporairement fixe
 Tijdelijk vast

-  Temporalmente fijo
 Temporaneamente fisso
 Dočasně pevný
 Midlertidigt rettet

- 5  Bestand vom Haus
 Inventory of the house
 Inventaire de la maison
 Inventaris van het huis

-  Inventario de la casa
 Inventario della casa
 Inventář domu
 Inventar af huset



Vergleichen Sie zuerst die Material-liste mit Ihrem Paketinhalt! Bitte haben Sie Verständnis, dass Beanstandungen nur im nicht aufgebauten Zustand bearbeitet werden können!



Vergelijk eerst de lijst van materialen met de inhoud van uw pakket! Reclamaties kunnen alleen in behandeling worden genomen zolang de onderdelen nog niet zijn gemonteerd!



Confrontate questa distinta materiali prima con il contenuto del pacchetto! Vi preghiamo di comprendere che eventuali reclami possono essere accolti solo prima del montaggio!



First compare the list of materials with your package contents! Please understand that complaints can be processed in the non-built status only!



Start med at kontrollere materialelisten med indholdet af den leverede pakke! Vi gør venligst opmærksom på at reklamationer kun kan behandles for materialer som ikke er blevet bearbejdet!



Nejprve přezkontrolujte obsah balení podle materiálového listu! Mějte pochopení pro to, že případnou reklamaci se můžeme zabývat pouze tehdy, když díly nebudou smontované! Za pomoci tohoto seznamu můžete jednotlivé díly přiřadit k montážnímu návodu.



Commencez par comparer la liste du matériel avec le contenu de votre paquet! Sachez que nous traitons uniquement les réclamations concernant le matériel à l'état non monté!



En primer lugar, compare la lista de material con el contenido del paquete. Rogamos entienda que las reclamaciones sólo pueden ser tramitadas antes de montar el objeto!

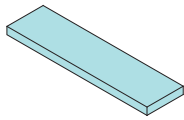
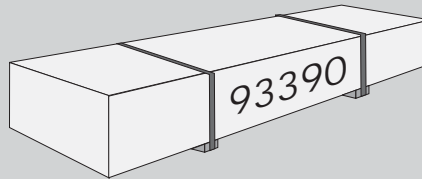
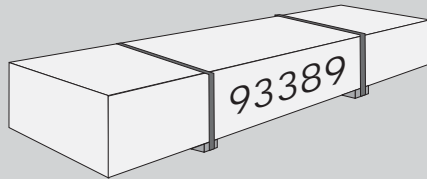

6 x A1	58 x 15 x 2 mm	ID 60125
3 x A2	755 x 15 x 2 mm	ID 93397

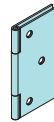

6 x	ID 62231
-----	----------

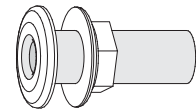

1 x	25 mm	ID 60126
-----	-------	----------



2 x B1	760 x 45 x 18 mm	ID 52603
3 x B2	1020 x 45 x 18 mm	ID 39268
2 x B3	2380 x 45 x 18 mm	ID 16368
2 x B4	1287 x 58 x 18 mm	ID 93397
8 x B5	2288 x 95 x 18 mm	ID 93391
21 x B6	684 x 120 x 18 mm	ID 93395
16 x B7	820 x 120 x 18 mm	ID 48774
9 x B8	2288 x 120 x 18 mm	ID 93393
4 x B9	728 x 58 x 28 mm	ID 48805
2 x B10	820 x 58 x 28 mm	ID 48804
7 x B11	1020 x 58 x 28 mm	ID 15475
4 x B12	1287 x 58 x 28 mm	ID 58725
10 x B13	1408 x 58 x 28 mm	ID 46366

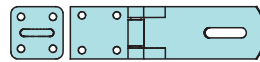

3 x	ID 3724
-----	---------

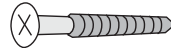

30 x	4 x 16 mm	ID 3690
140 x	4 x 30 mm	ID 3686
230 x	4 x 40 mm	ID 21925
70 x	4 x 70 mm	ID 3689

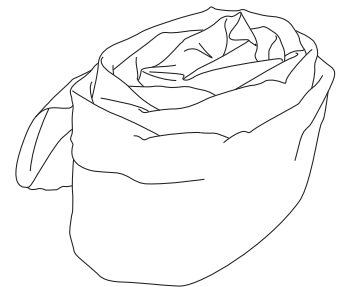

1 x	ID 65384
-----	----------

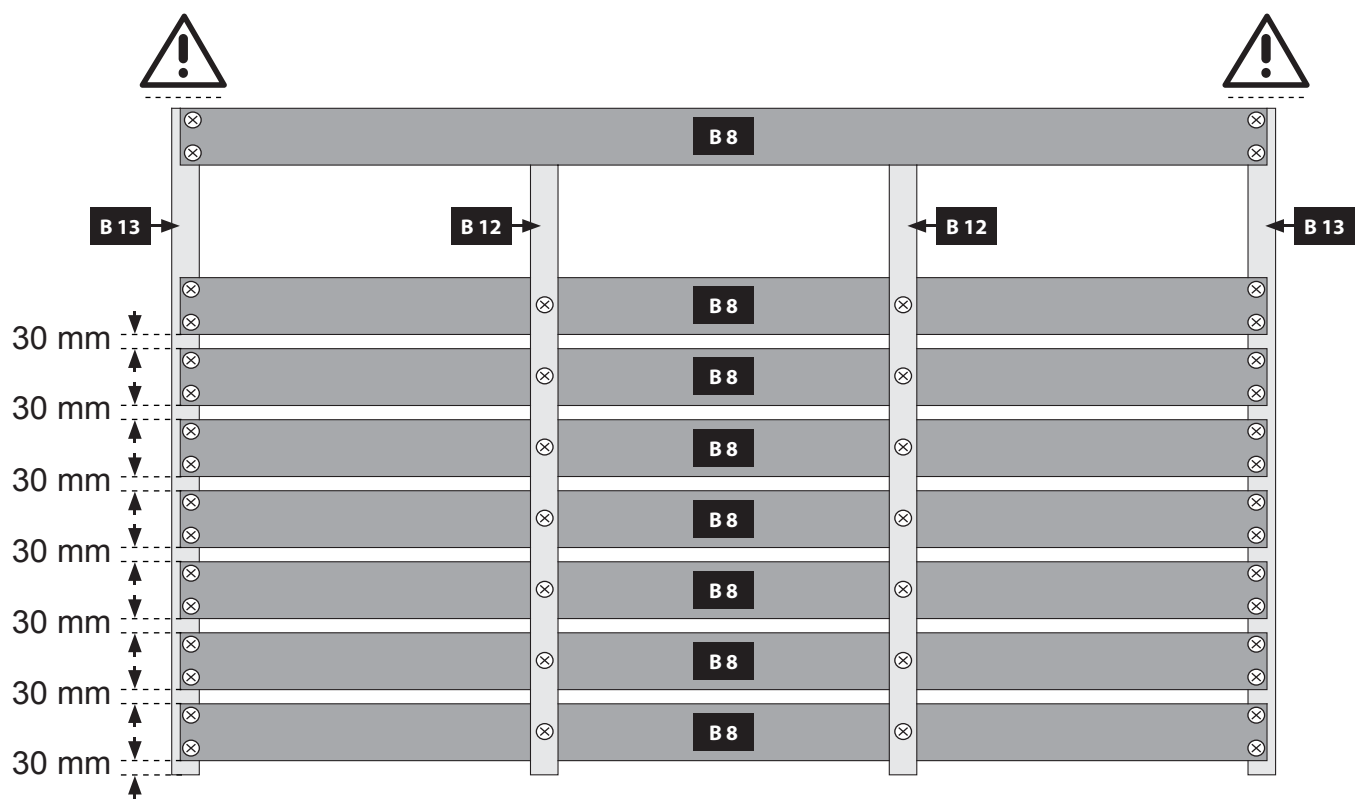
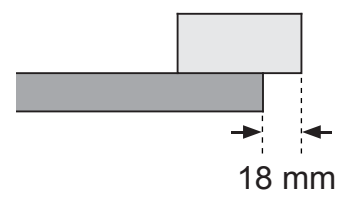
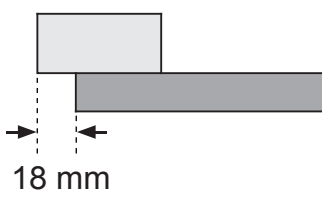
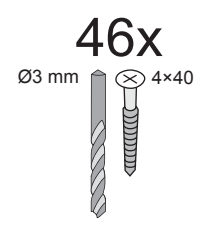



64x

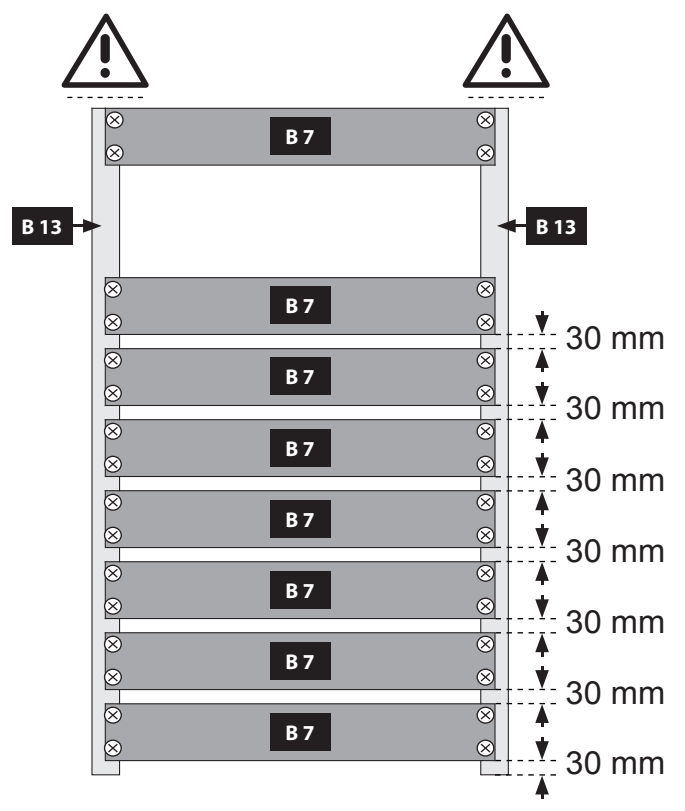
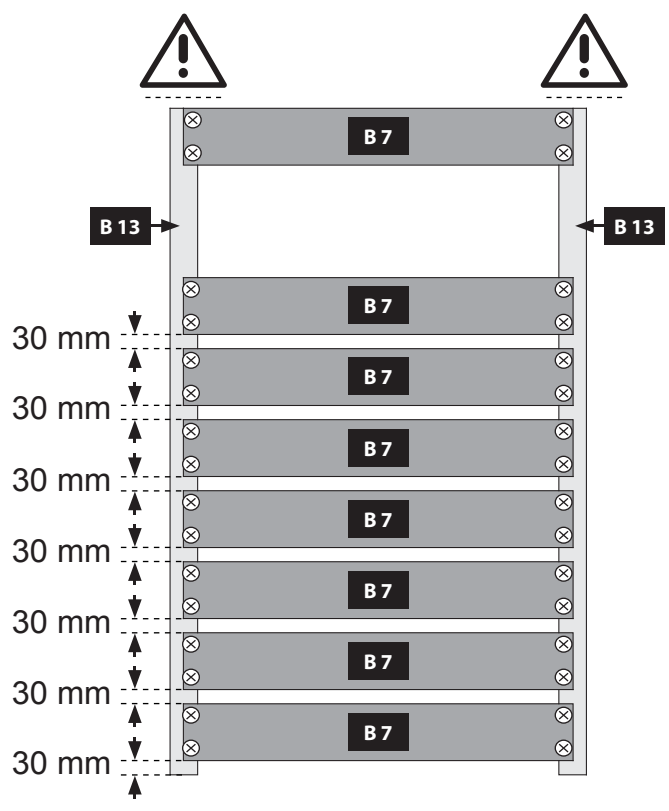
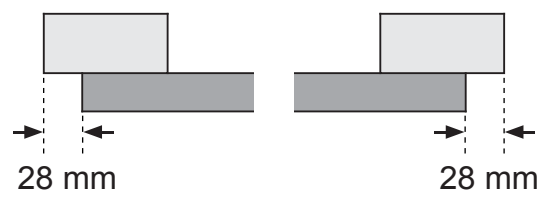
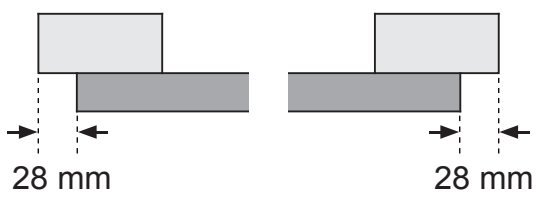
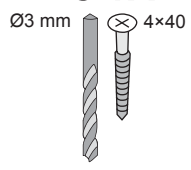

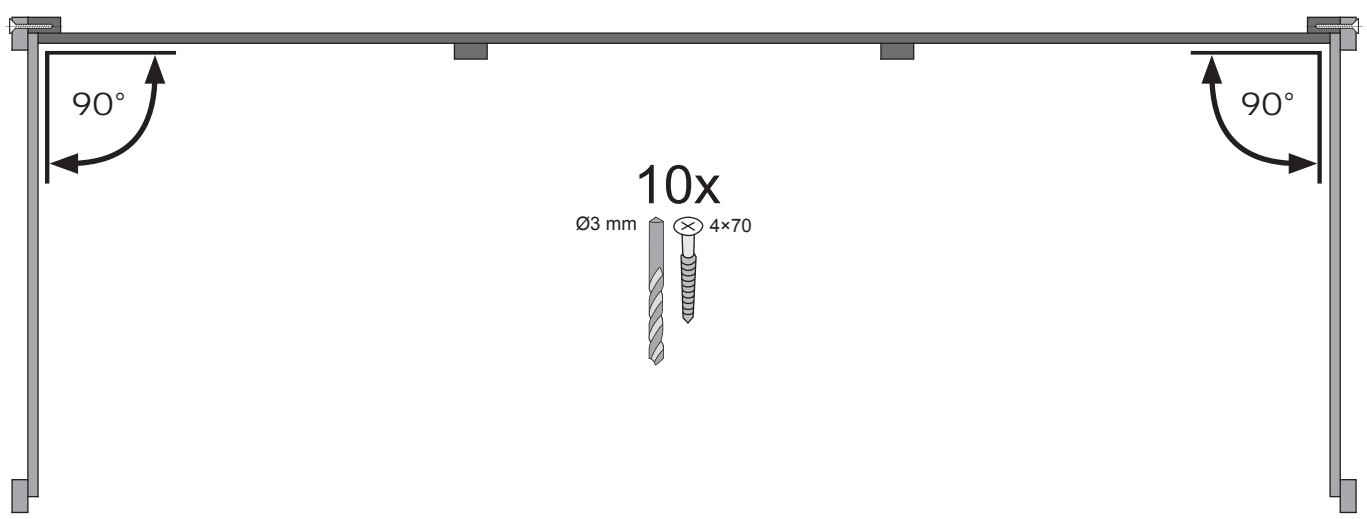
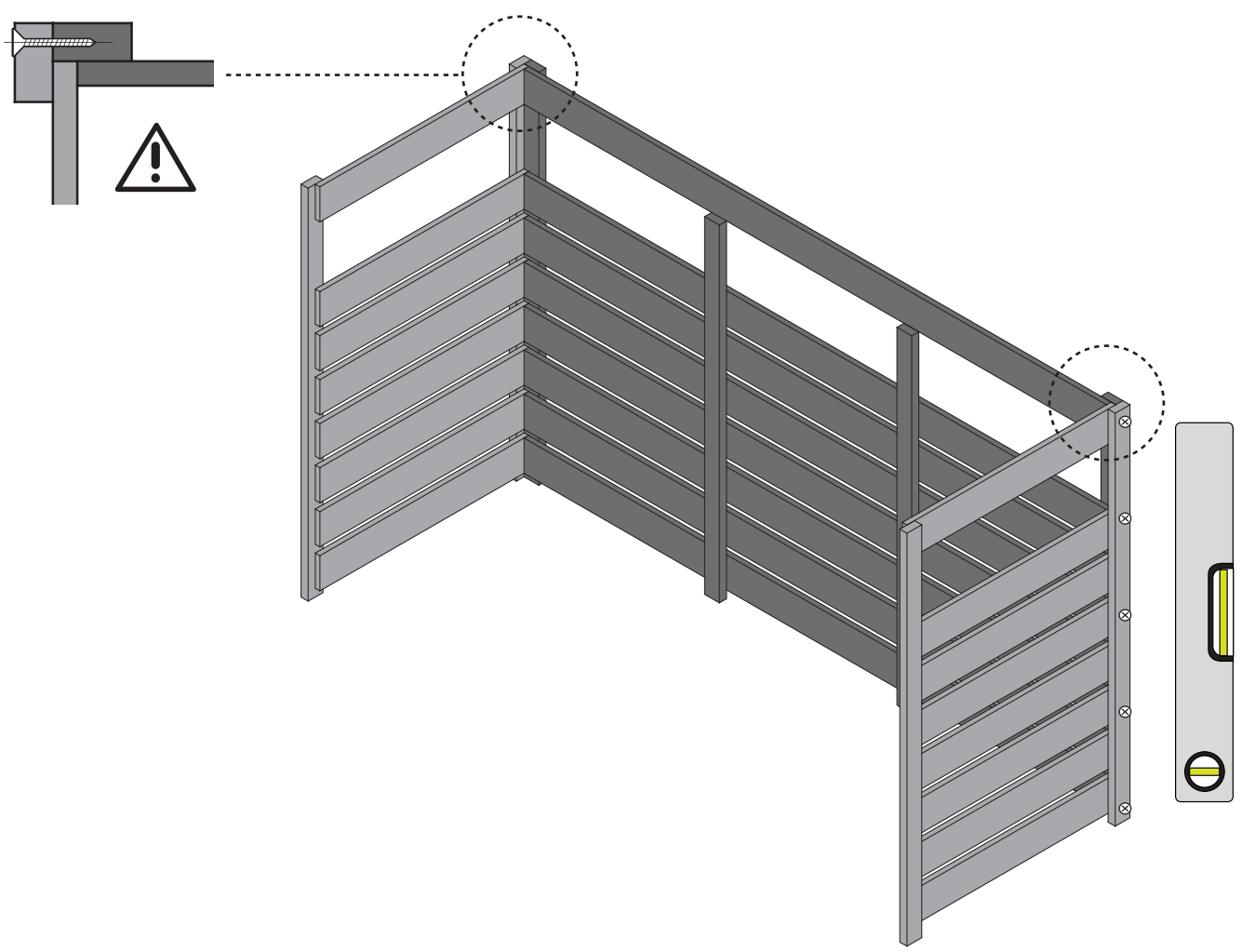

16x
Ø3 mm 4x70

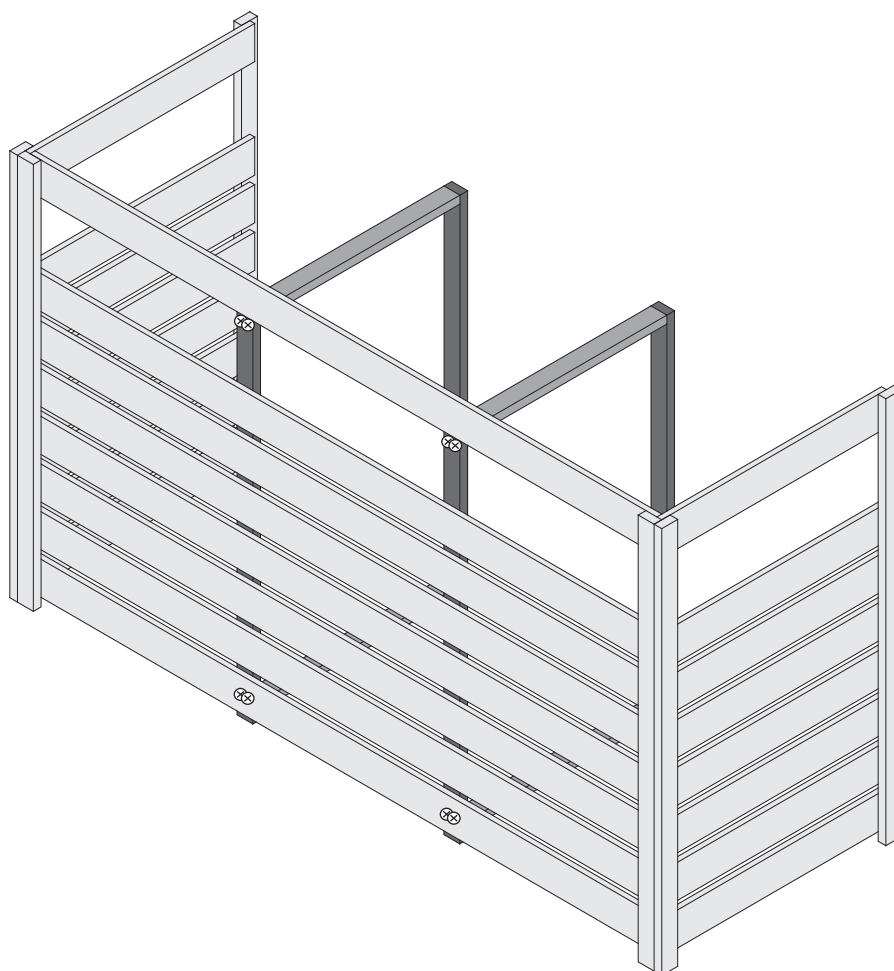
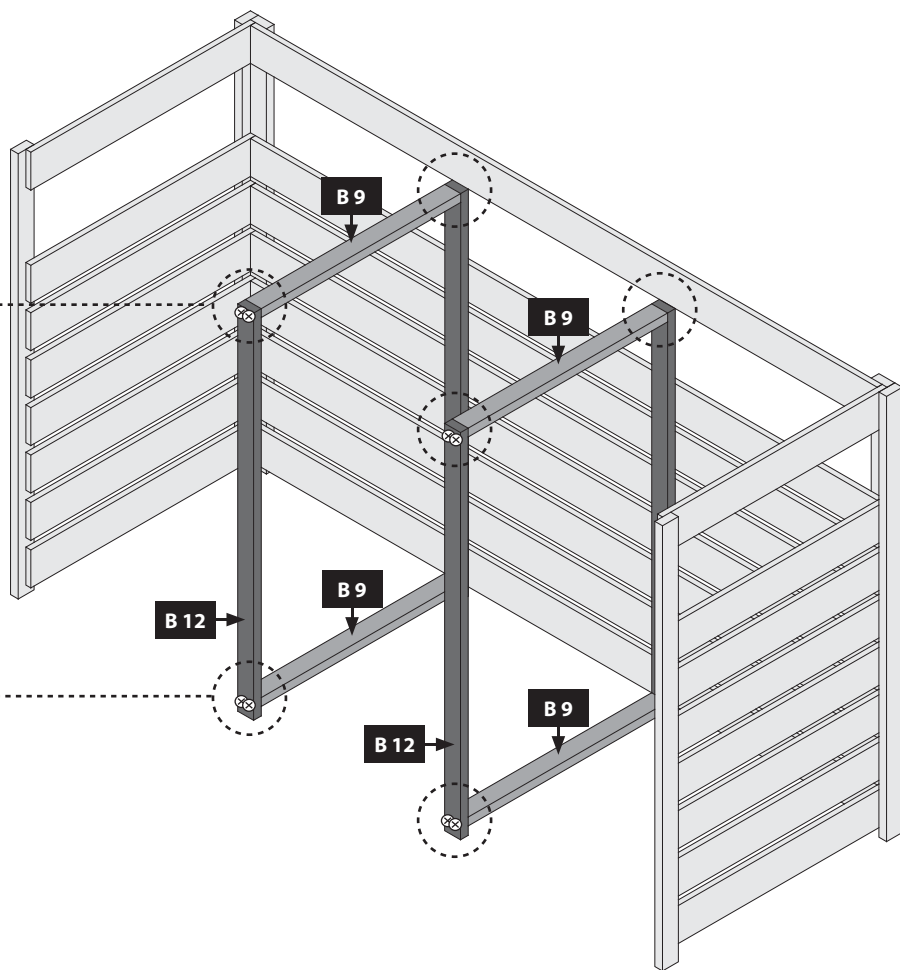
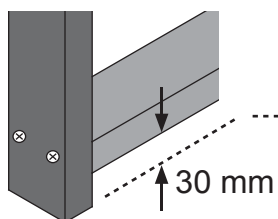
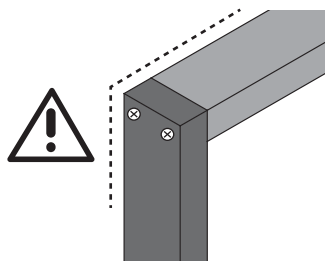

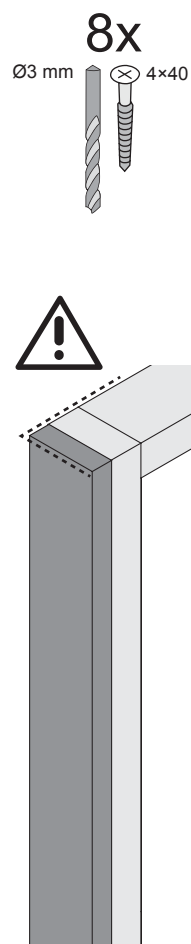
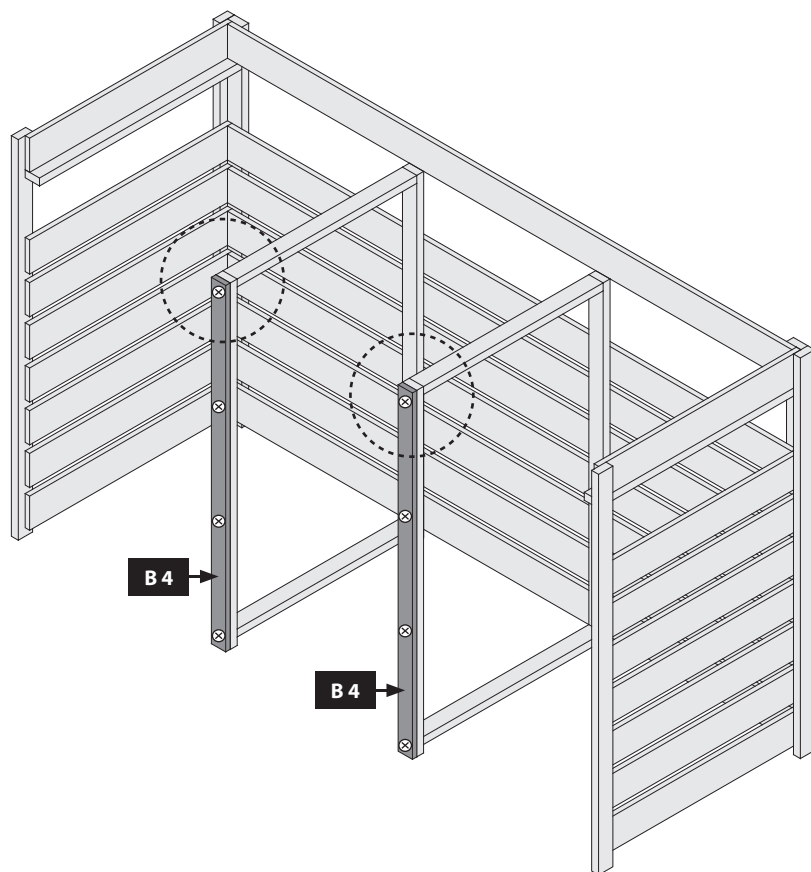
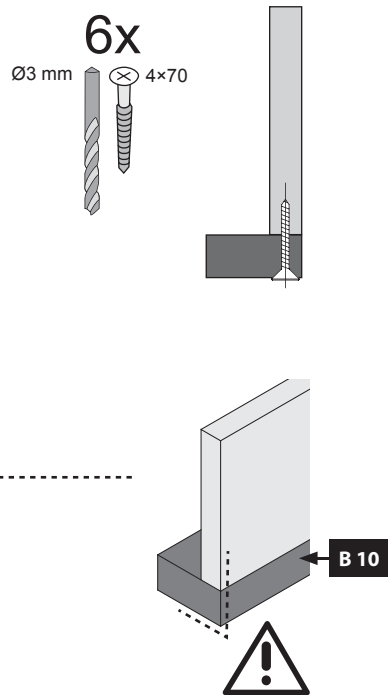
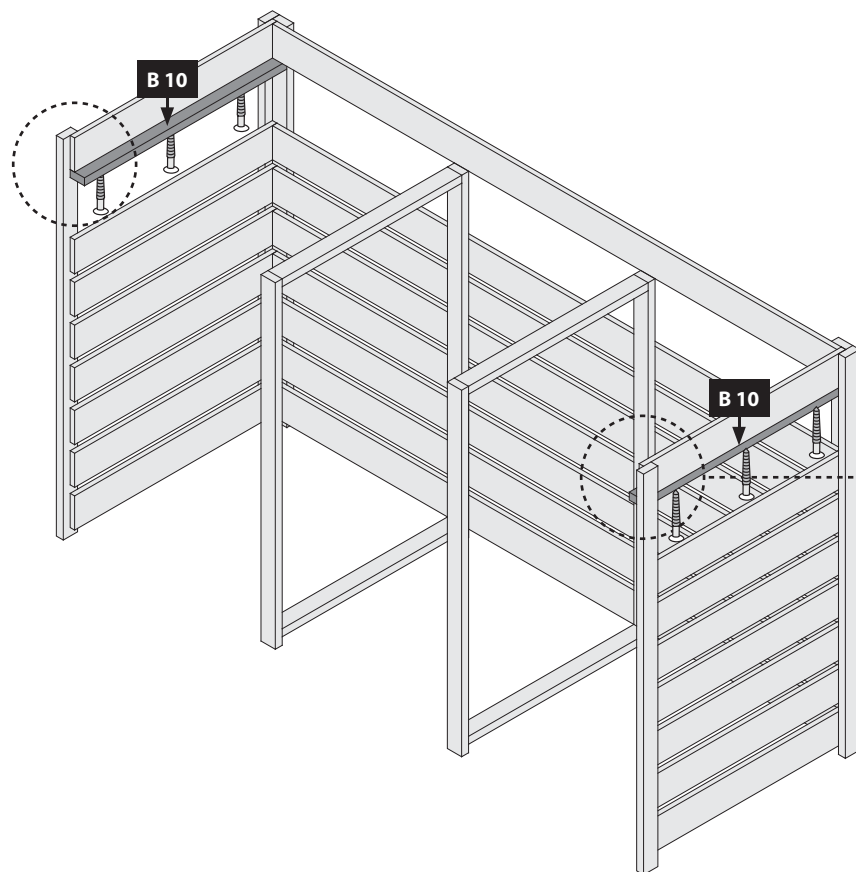

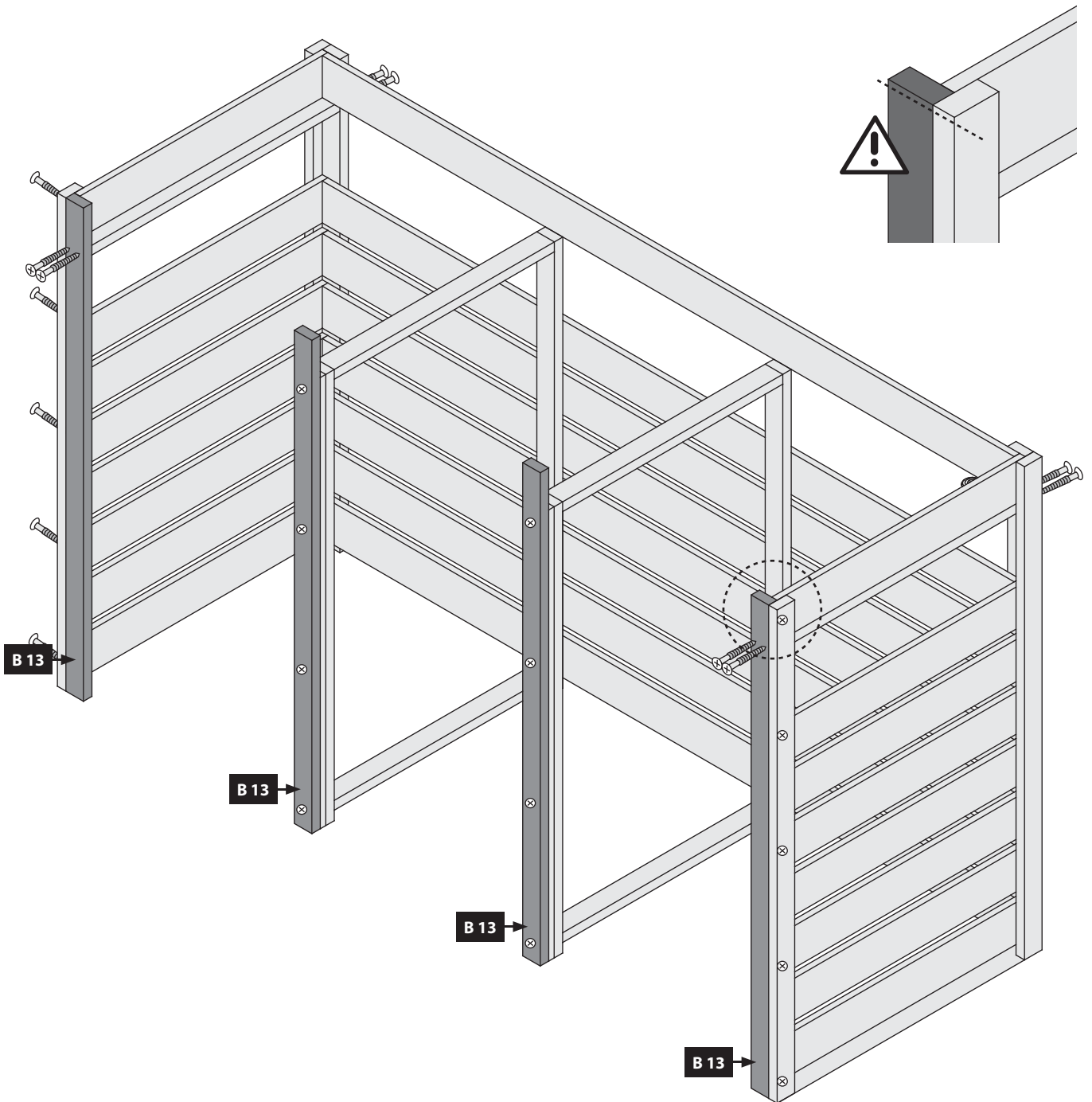
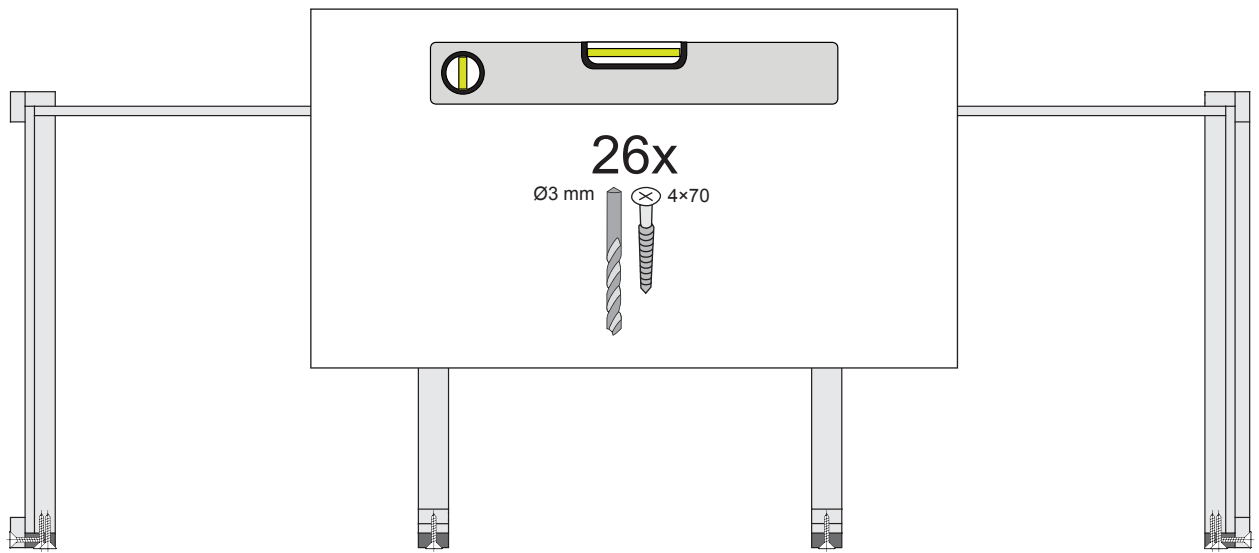

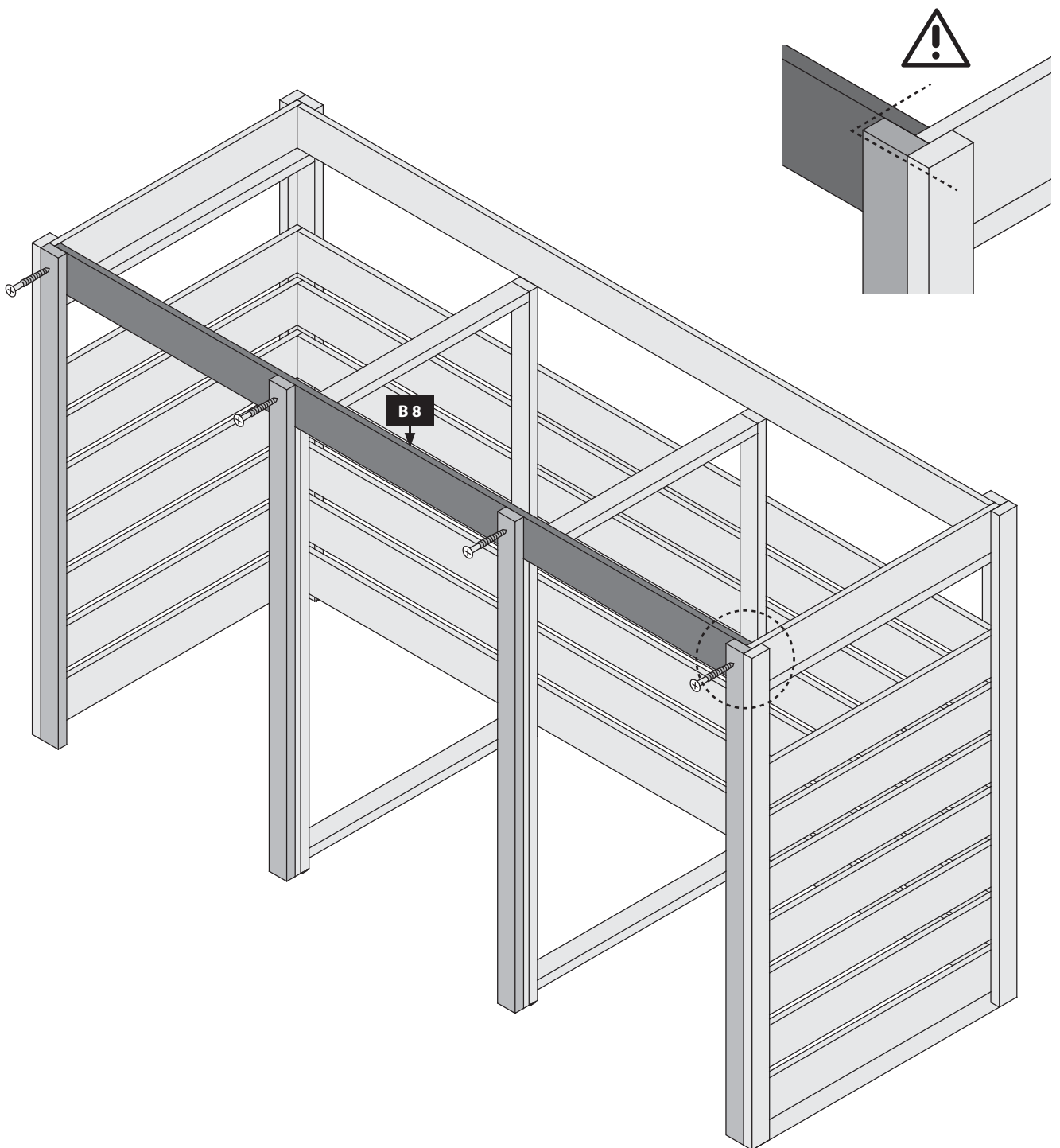
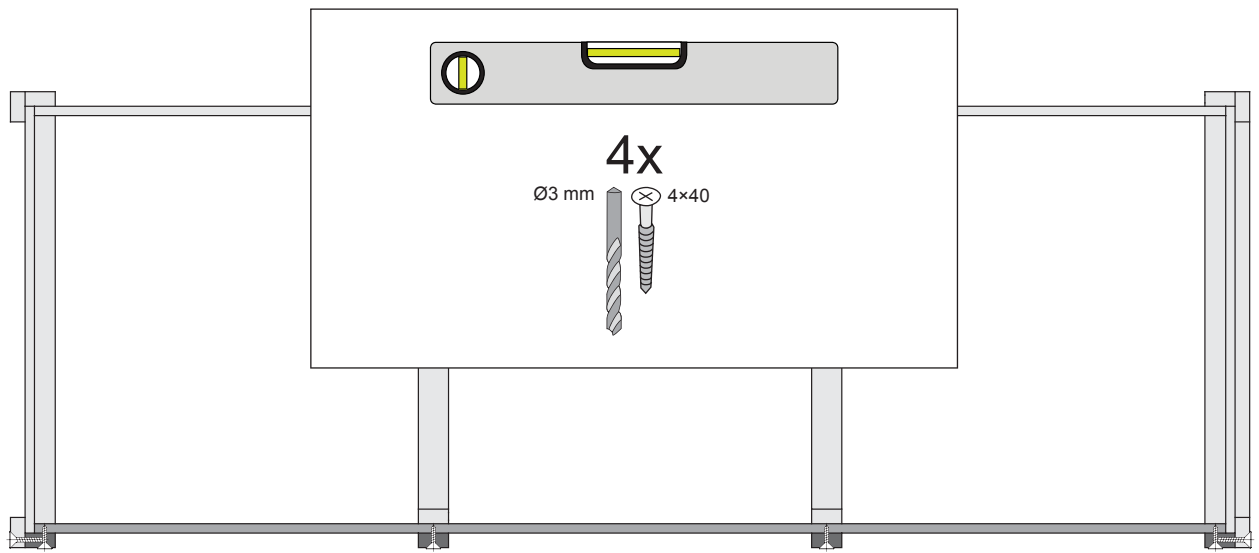



64x
 Ø3 mm 4x30

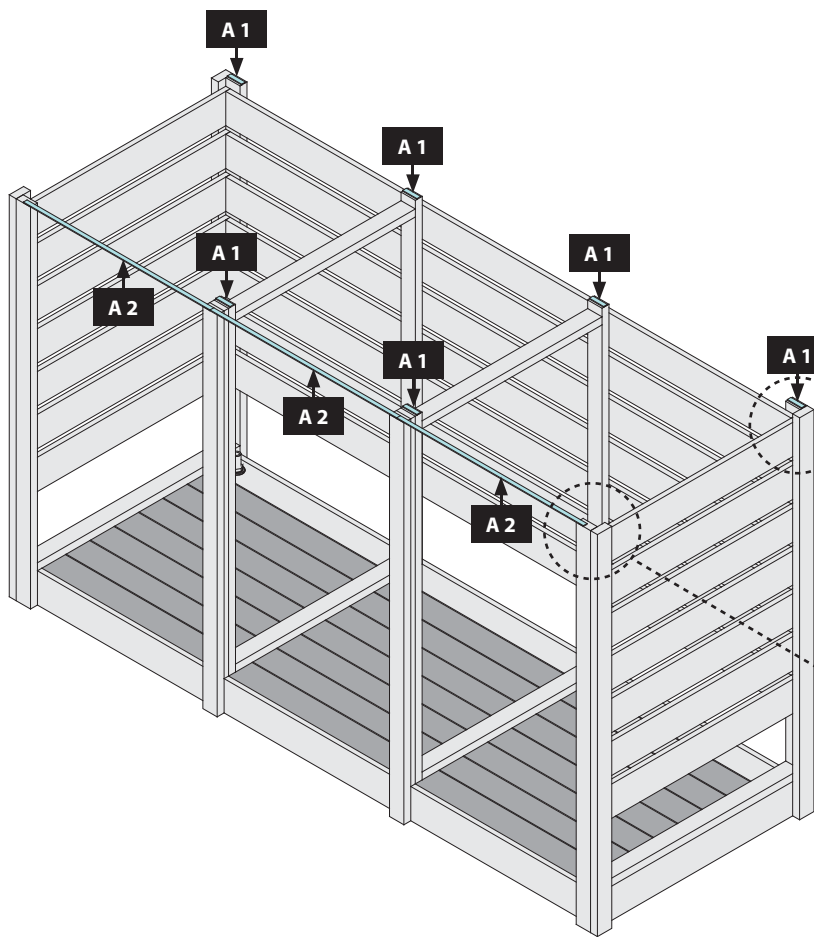
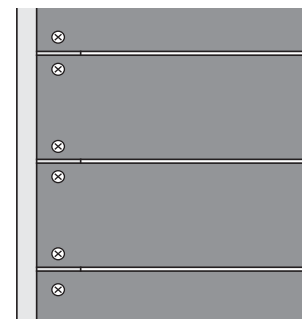

18x
 Ø4 mm 4x30

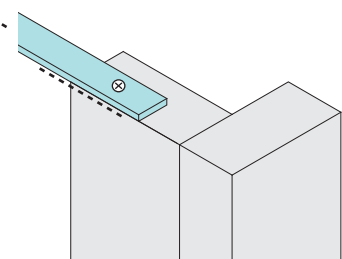
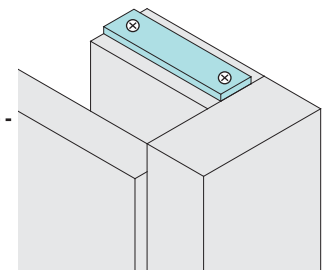
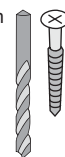



15x

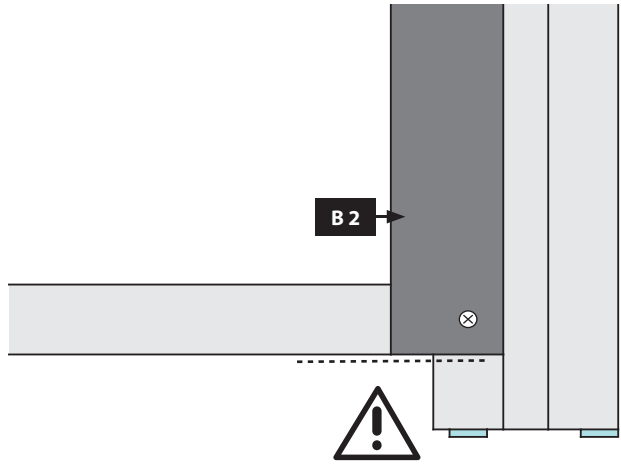
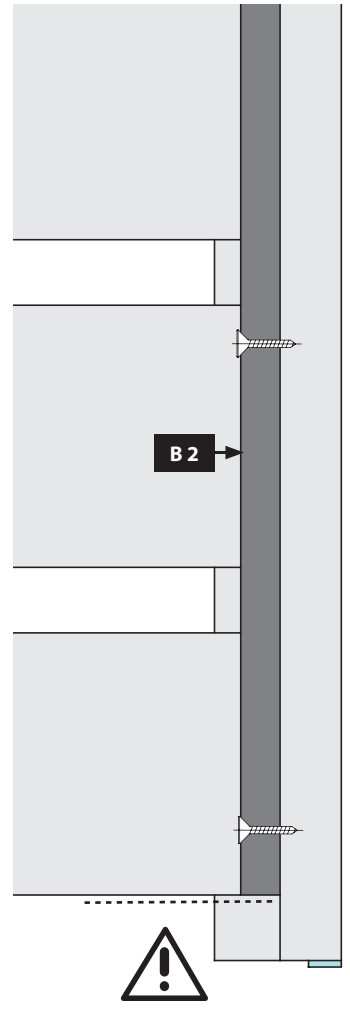
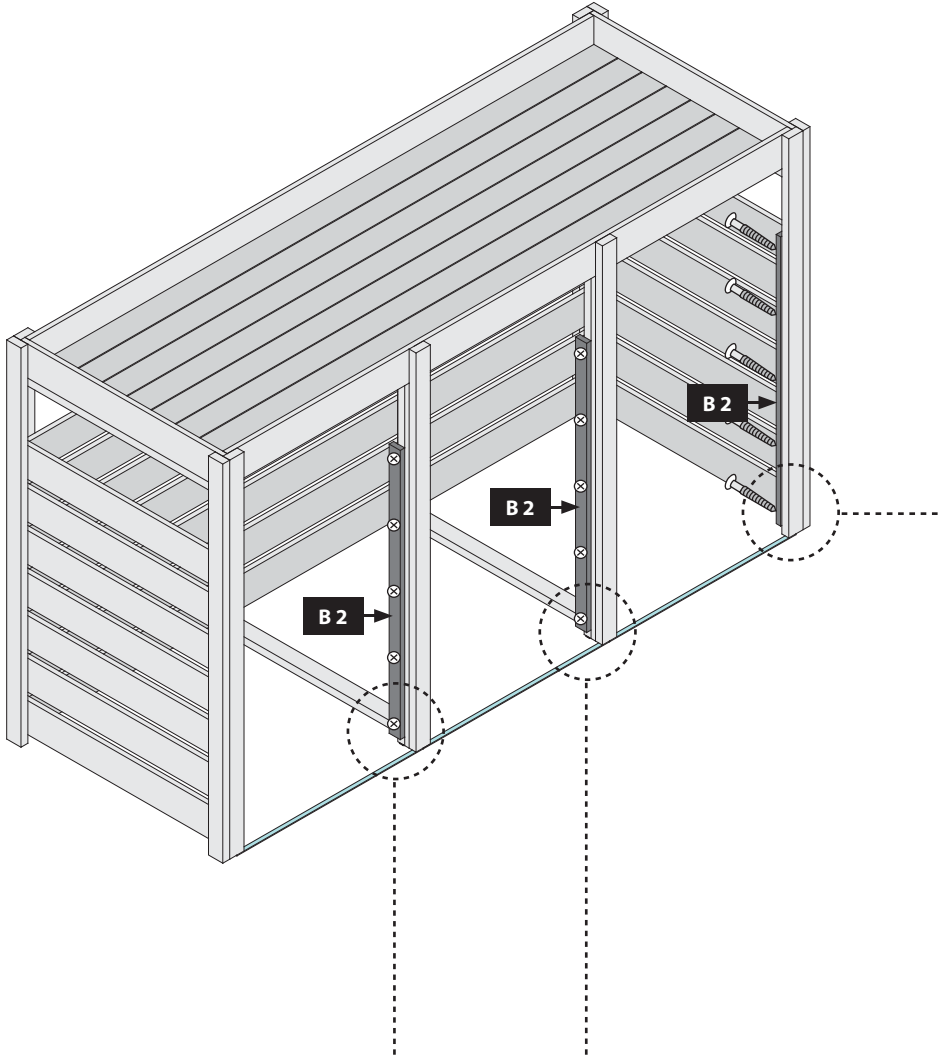
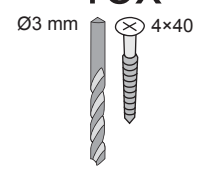



5x
Ø3 mm 4x40

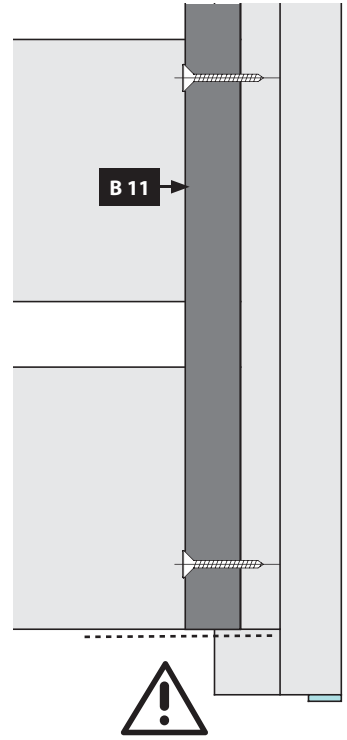
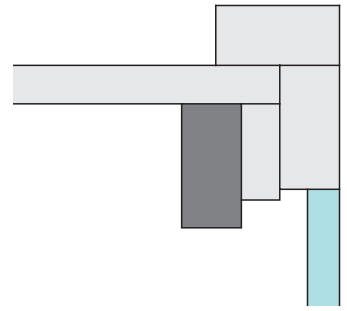
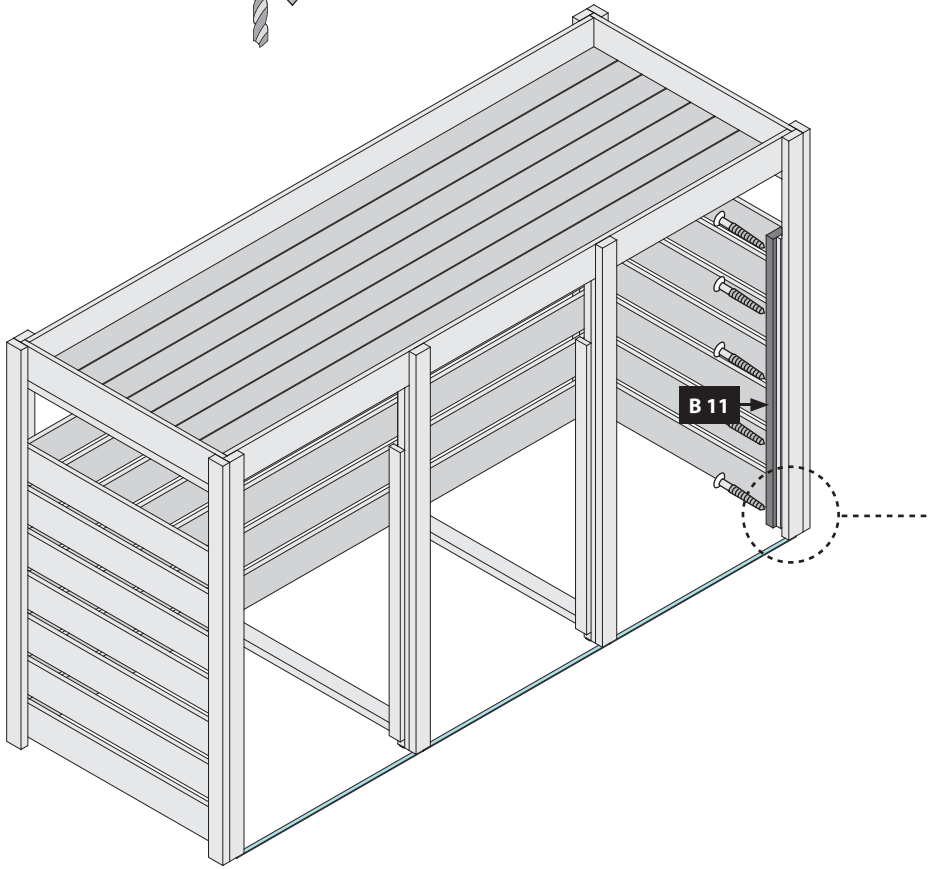

84x
Ø3 mm 4x40

3x

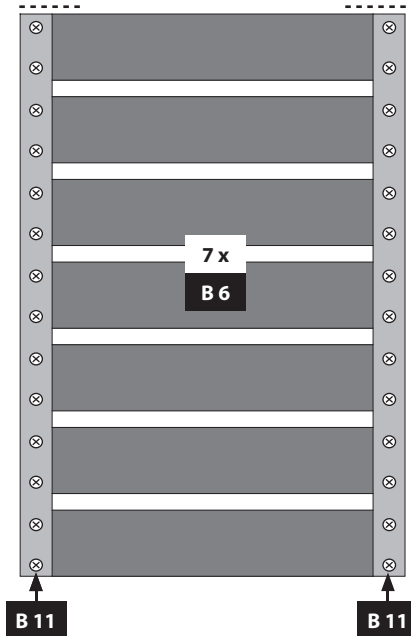

-  Leim!
 -  Glue!
 -  Colle!
 -  Lijm!
 -  Lim!
 -  Pegamento!
 -  Colla!
 -  Klíh!
- * 

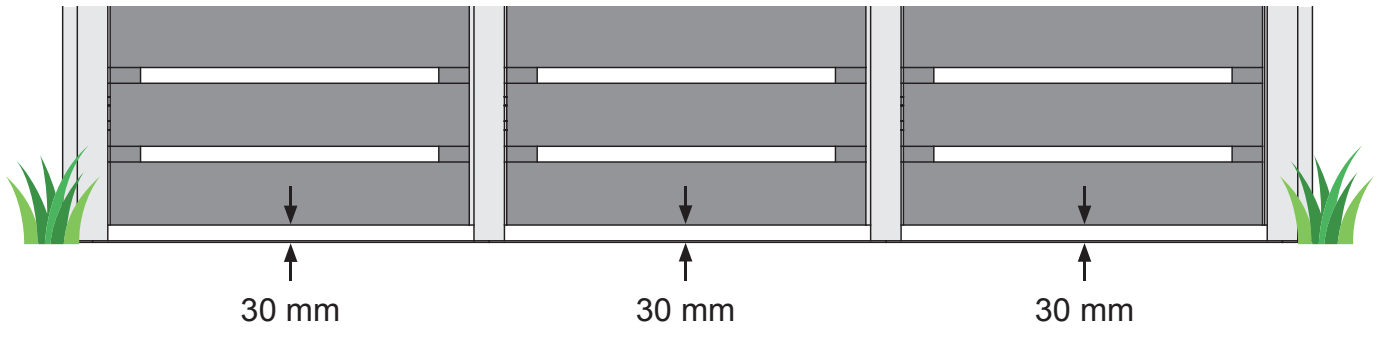
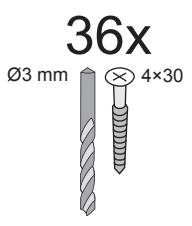
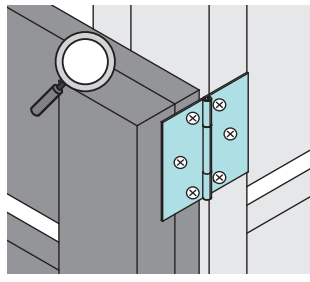
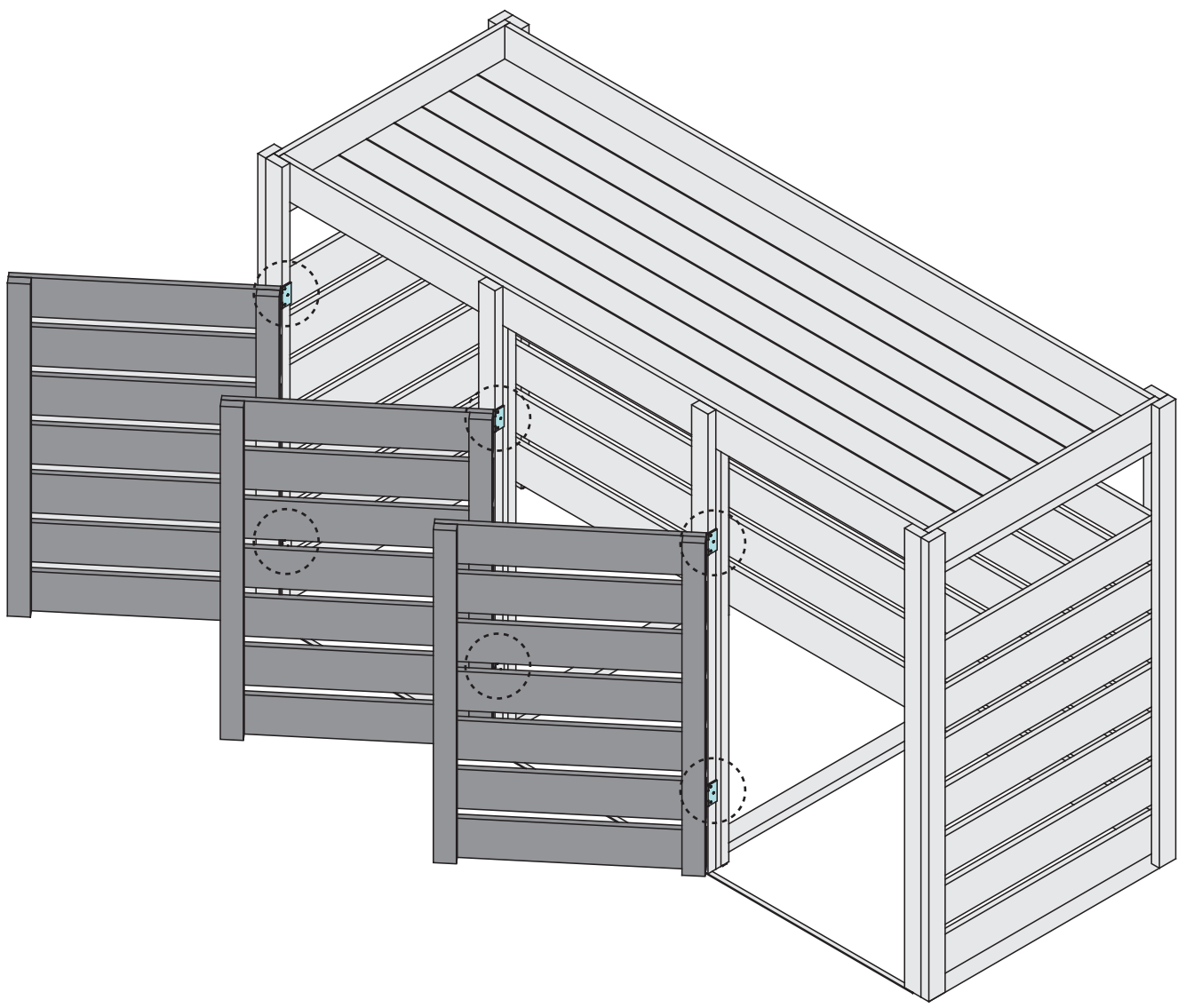

Ø3mm
12x 4x16

Ø3mm
12x 4x16

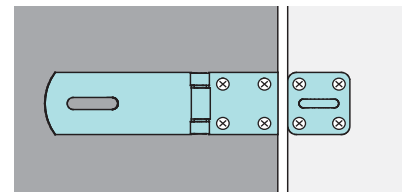
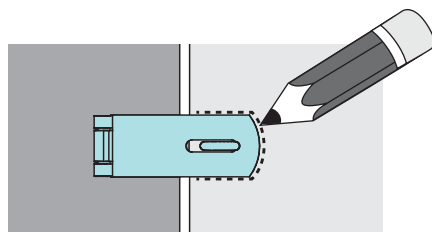
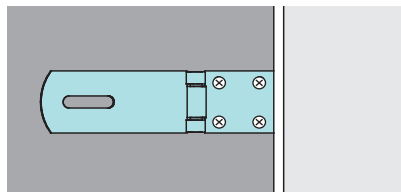

1.

2.

3.

