

Technische Daten Terrasse 70.5

Wandaußenmaß: 500 x 200 cm

Bohlenstärke: 70 mm

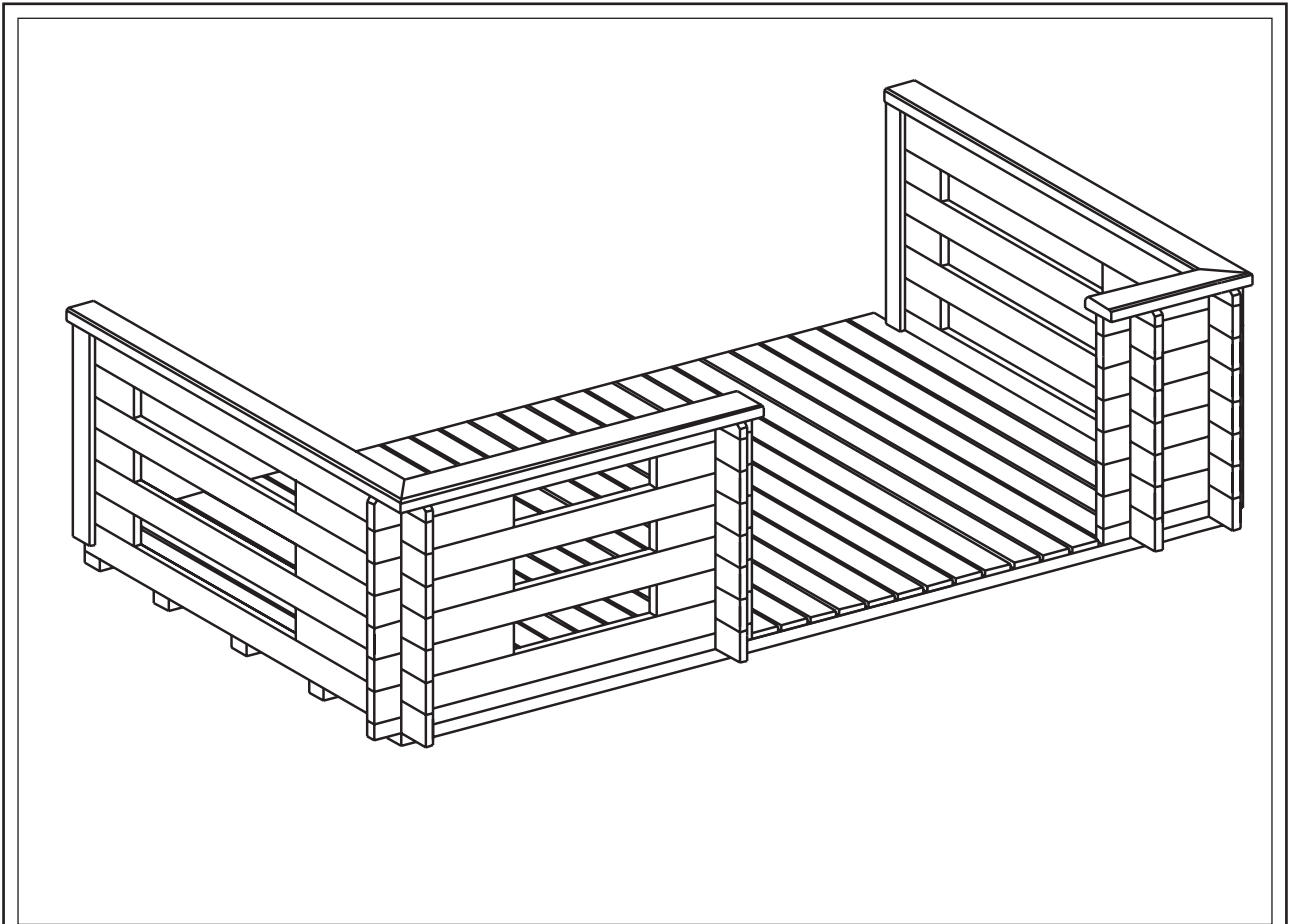

Kontrolliert durch:

Achtung: Alle angegebenen Maße sind ca.-Maße!

Grundriss und Lagerholzplan Terrasse 70.5

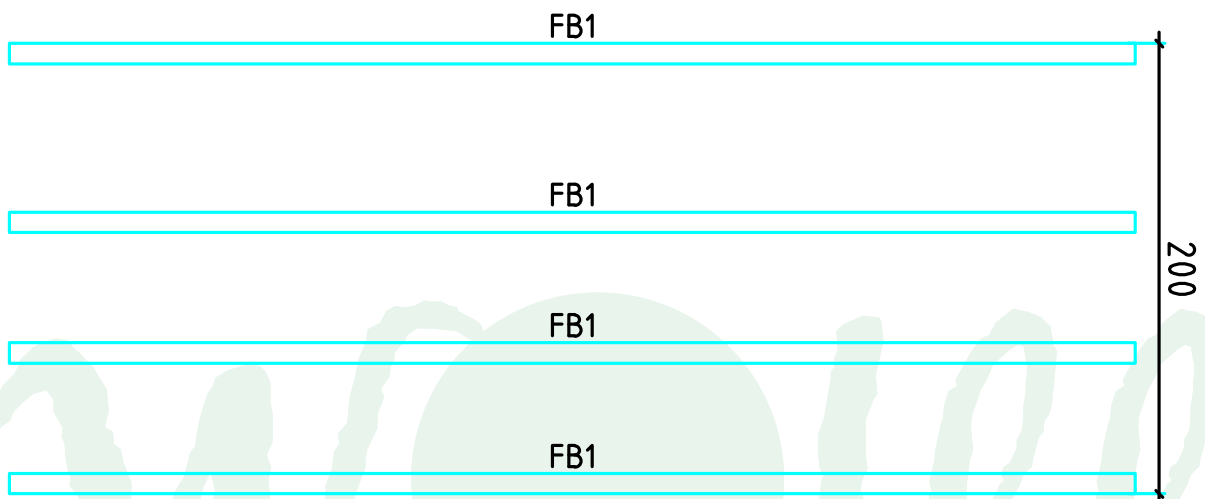
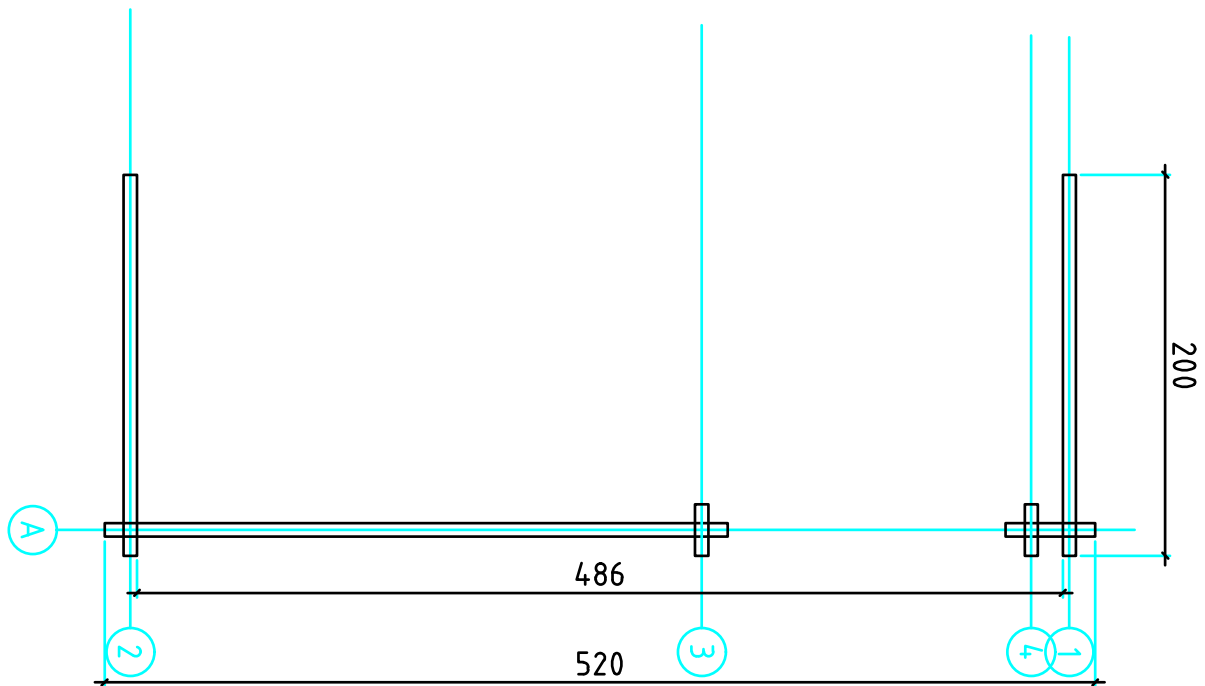

Fundamentplan Terrasse 70.5

Typ	Anzahl der Fundamenthölzer (B x H x L)
Terrasse 70.5	Fundamentholz: 4 (90 x 45 x 5000 mm)

Vorschlag 1:
Streifenfundament
Schotter fest gerüttelt
oder Beton!
ca. 250 mm breit
ca. 600 mm tief

Vorschlag 2:
Gesamte Fläche
schottern!



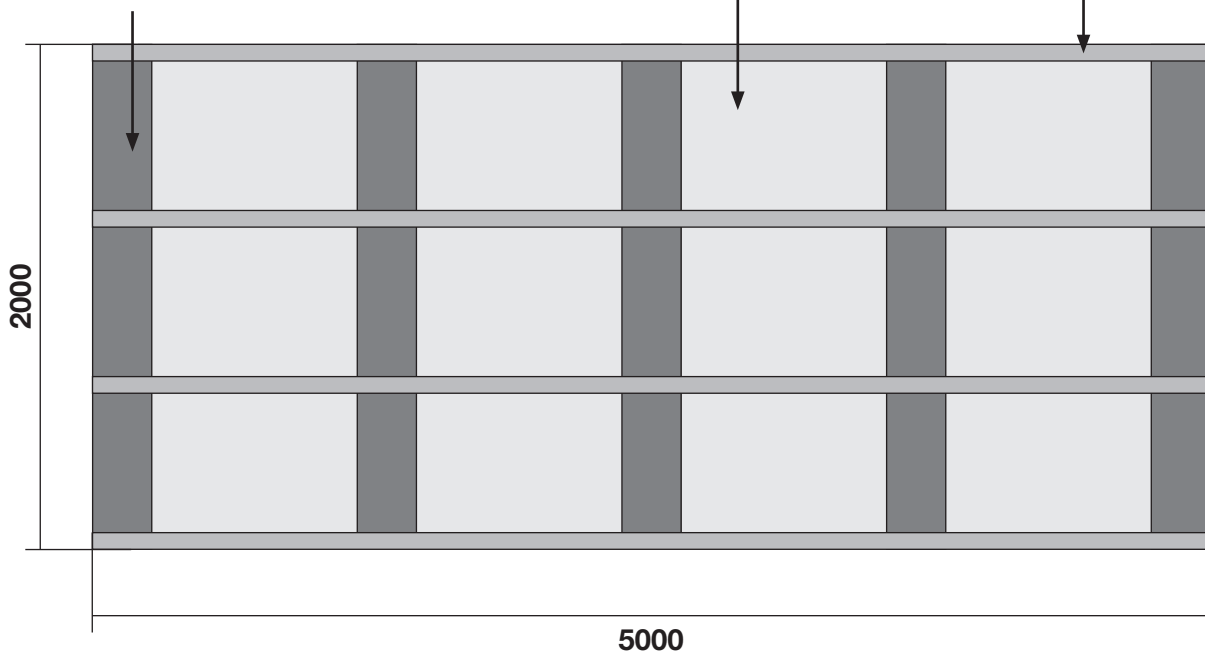





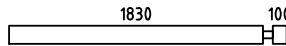

**Fundament-
holz**

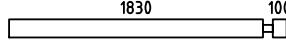

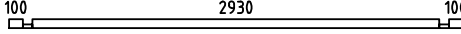
**Dieser Fundamentplan ist ein unverbindlicher Vorschlag und kann
individuell verändert werden!**

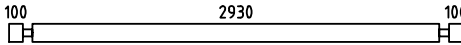
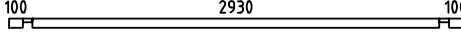
Teileliste 1

Terrasse 70.5

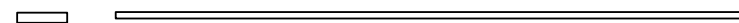
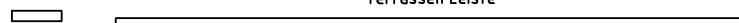
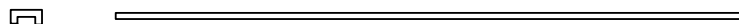
Pos		Arv	Profiil (mm)	LENGHT (mm)
001		2	70x130	2000
002		6	70x130	270
003	100100 	24	70x130	270
004		6	70x130	2000
005	100100 	2	70x130	270
006		1	70x65	3270
007	100 130 100 	1	70x65	470
008	100 130 100 	6	70x130	470
009		3	70x130	3270
010		1	70x65	3270
011	100 130 100 	1	70x65	470
FB1	FLOORBEAMS 	4	90x45	5000
FB2	FLOORBOARDS  8,89 m2		20x...	1830
TL1	Terrassen Leiste 	2	20x120	2100
TL2	Terrassen Leiste 	1	20x120	3350
TL3	Terrassen Leiste 	1	20x120	550
TL 4	Terrassen Leiste 	2	90x45	910

Teileliste 2

Terrasse 70.5

	001 / 2 1. rida
	002 / 6
	003 / 24
	004 / 6
	005 / 2 1. rida
	006 / 1 1. rida
	007 / 1 1. rida
	008 / 6
	009 / 3
	010 / 1

Teilleiste 3 Terrasse 70.5

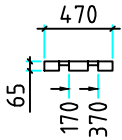

011 / 1

FLOORBEAMS

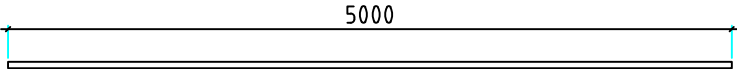

FB1 / 4
90x45



Wandplan 1 und 2 Terrasse 70.5

7
6
5
4
3
2
1
wall¹ 1

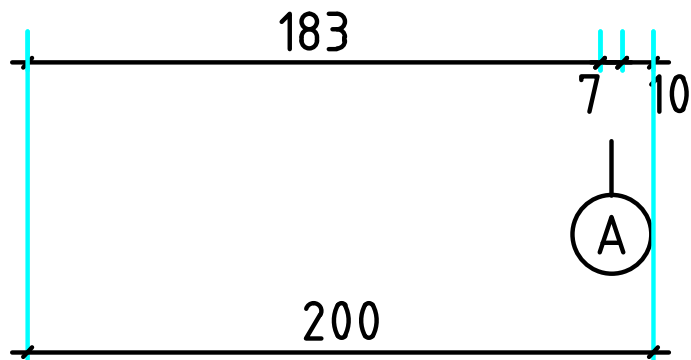
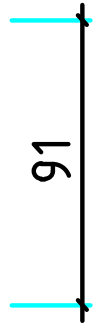

7
6
5
4
3
2
1
wall¹ 2

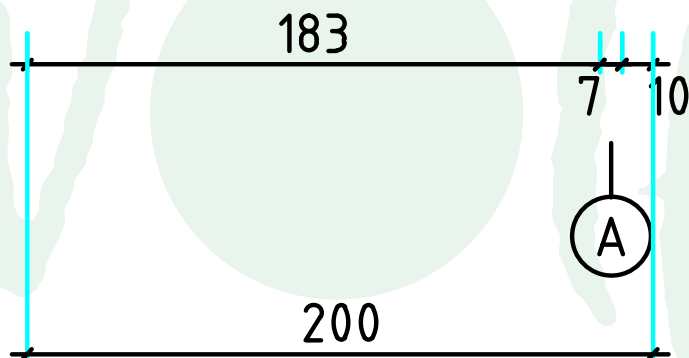
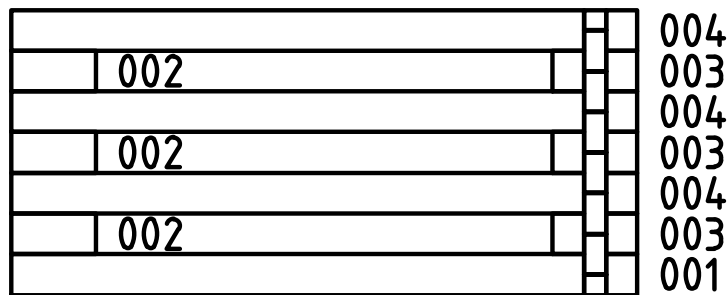

Wandplan 3 und 4 Terrasse 70.5

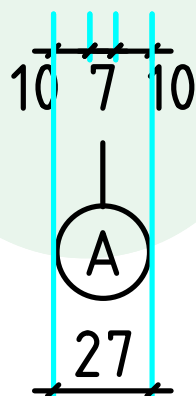
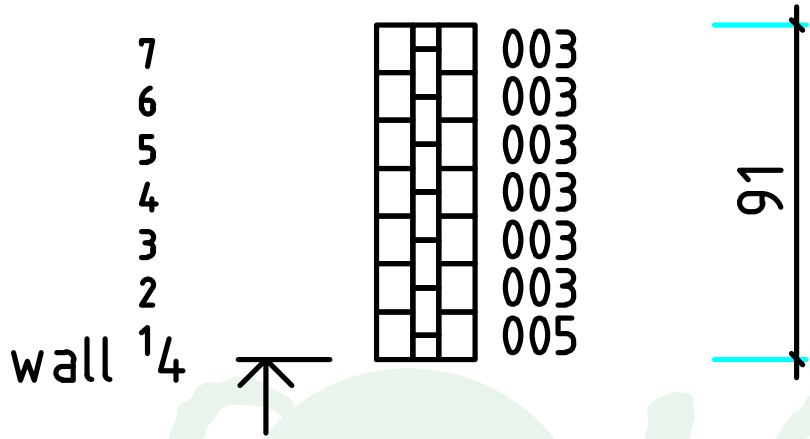
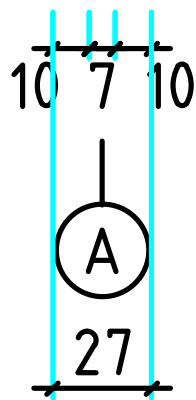
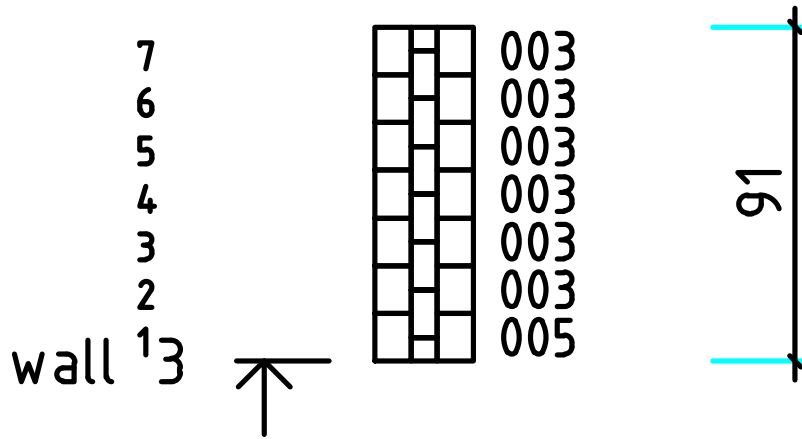

Wandplan A Terrasse 70.5

