

# Technische Daten Terrasse 70.2

Wandaußenmaß: 390 x 200 cm

Bohlenstärke: 70 mm

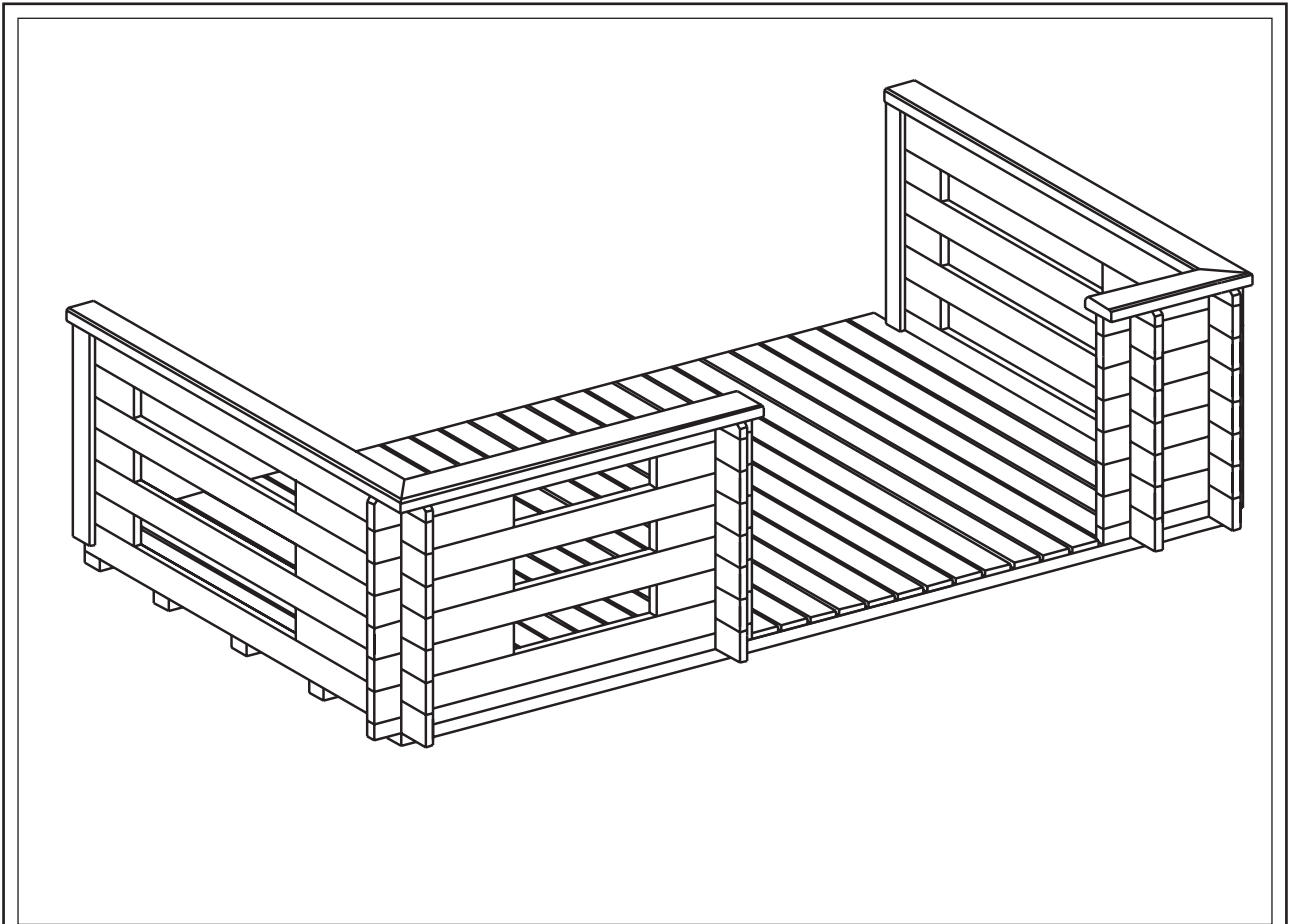

Kontrolliert durch:

Achtung: Alle angegebenen Maße sind ca.-Maße!

# 3-D Darstellung Terrasse 70.2

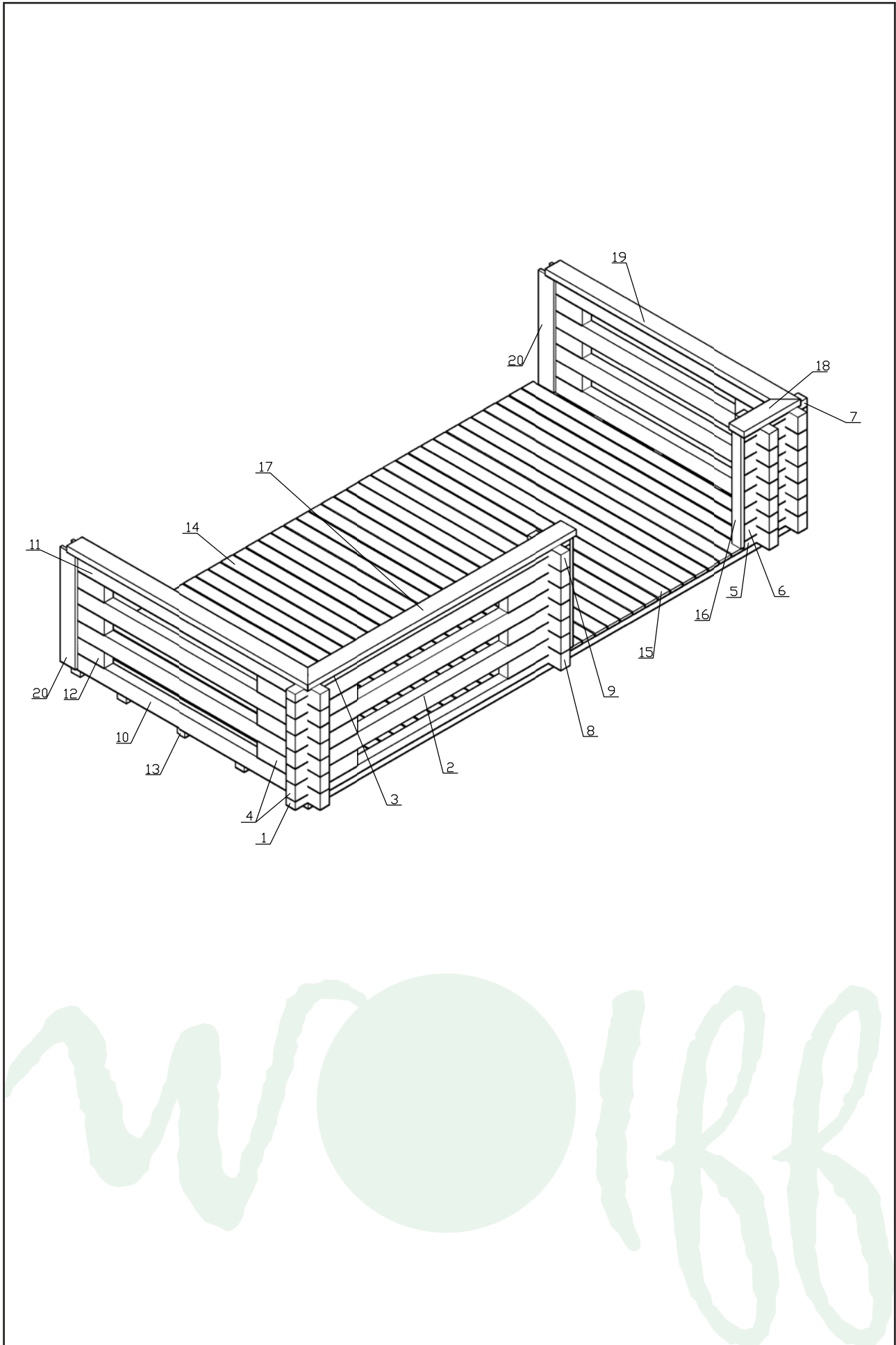

# Grundriss Terrasse 70.2

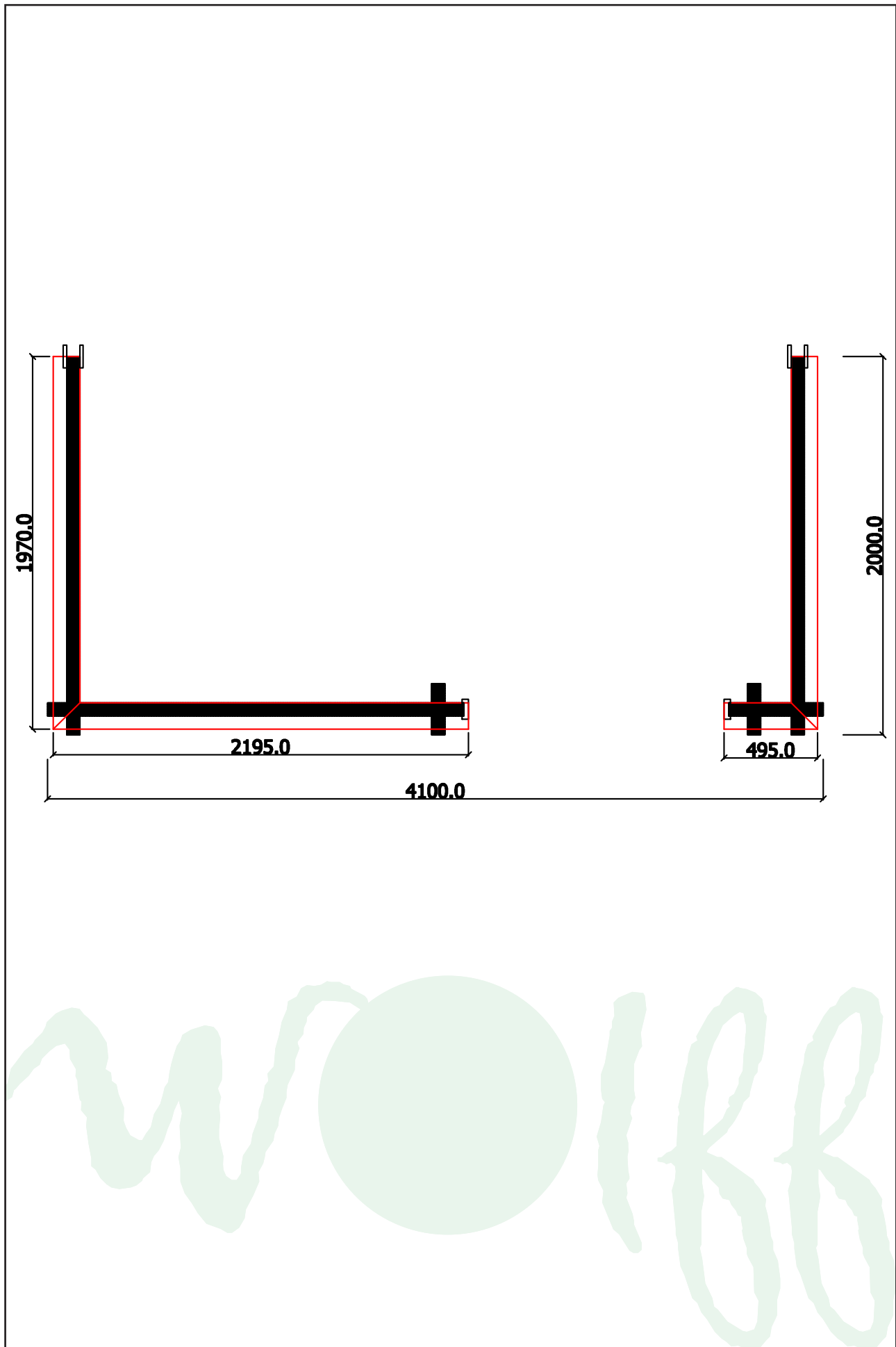

# Fußbodenplan Terrasse 70.2

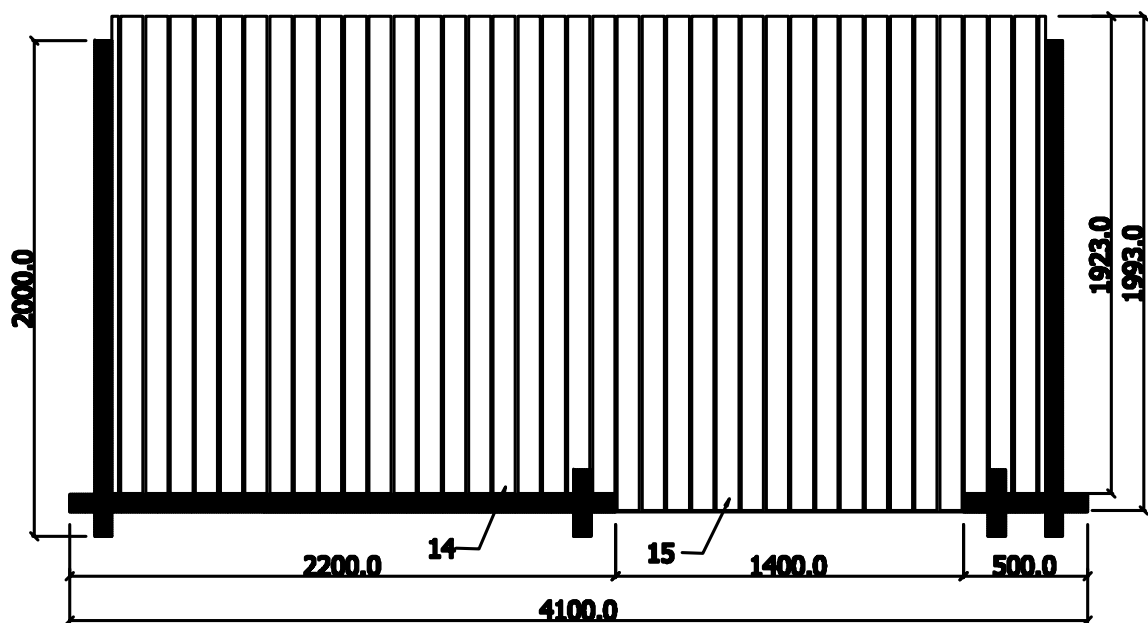

# Lagerholzplan Terrasse 70.2

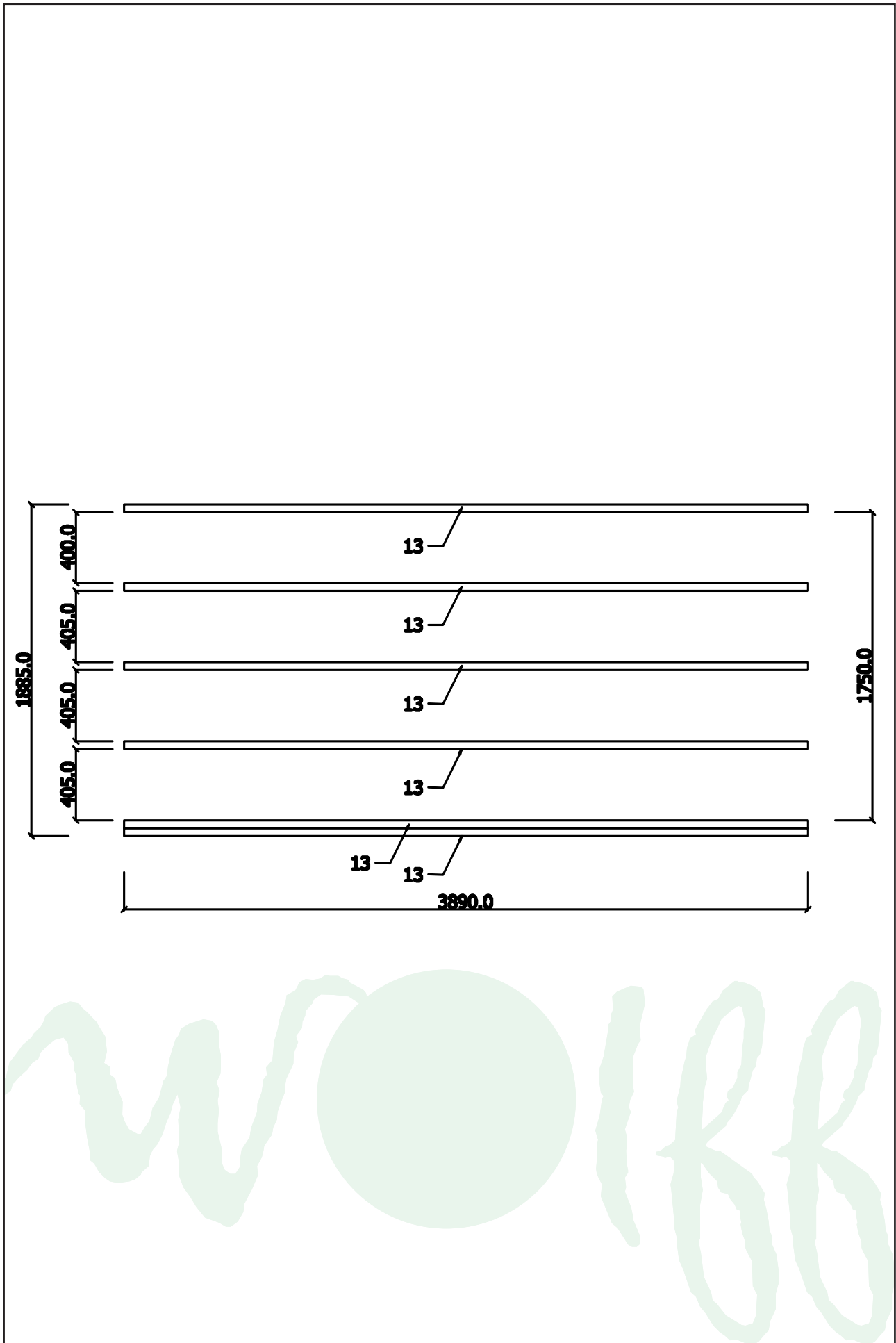

# Fundamentplan Terrasse 70.2

Typ	Anzahl der Fundamenthölzer (B x H x L)
Terrasse 70.2	Fundamentholz: 6 (45 x 70 x 3890 mm)

**Vorschlag 1:**  
Streifenfundament  
Schotter fest gerüttelt  
oder Beton!  
ca. 250 mm breit  
ca. 600 mm tief

**Vorschlag 2:**  
Gesamte Fläche  
schottern!



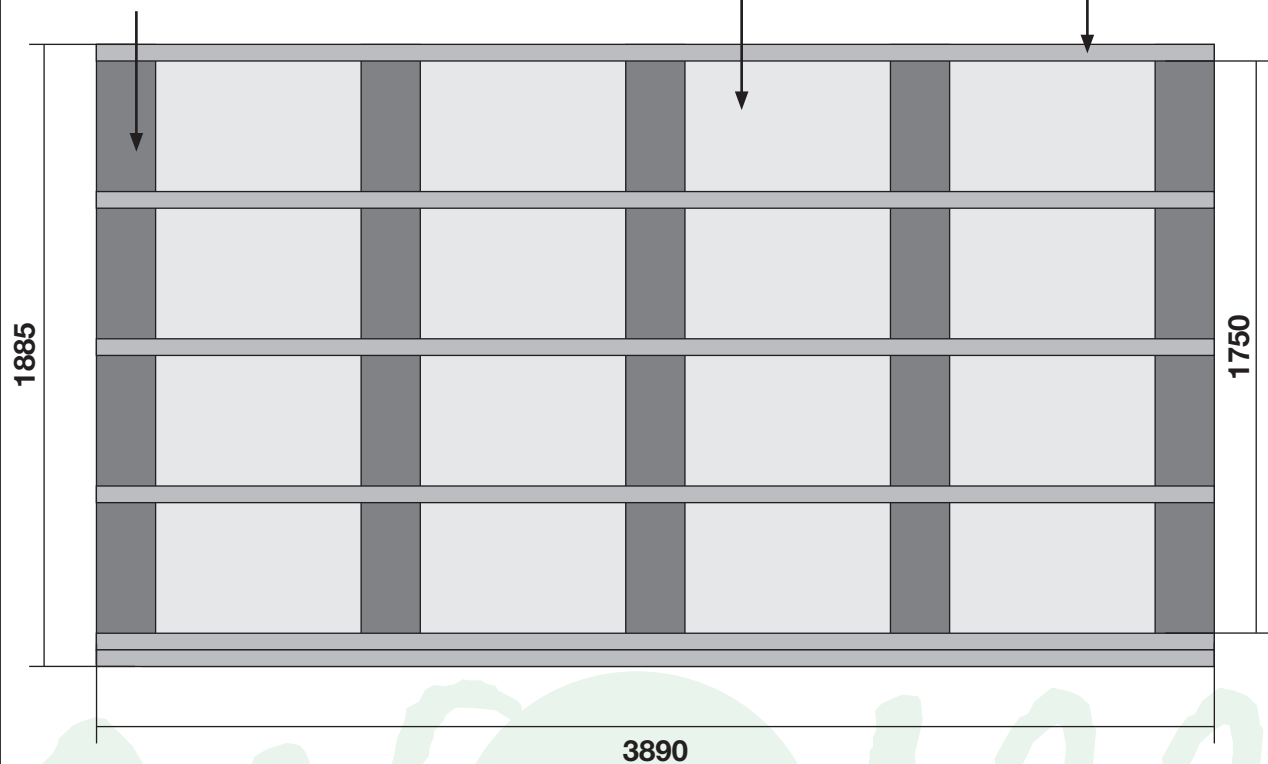





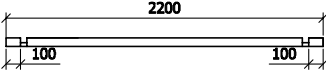
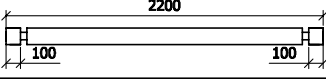
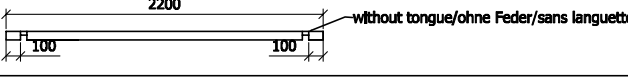
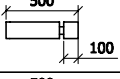
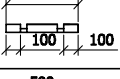
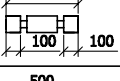
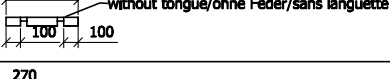

**Fundament-  
holz**

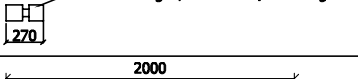
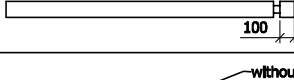
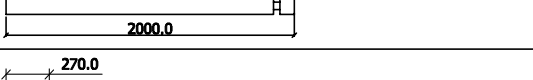
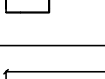
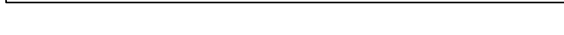



**Dieser Fundamentplan ist ein unverbindlicher Vorschlag und kann  
individuell verändert werden!**

# Teileliste 1

## Terrasse 70.2

Code - Nr.		Pcs - Stück	Profil- Profil(mm)	Length - Länge(mm)
1		1	70X57	2200
2		3	70X114	2200
3		1	70X57	2200
4		12	70X114	500
5		1	70X57	500
6		6	70X114	500
7		1	70X57	500
8		12	70X114	270
9		2	70X114	270
10		6	70X114	2000
11		2	70X114	2000
12		6	70X114	270
13		6	45X70	3890
14		25	18X90	1923
15		14	18X90	1993
16		2	35X70	780
17		1	44X140	2195
18		1	44X140	495
19		2	44X140	1970
20		4	18X120	798

# Teileliste 2 Terrasse 70.2

Code - Nr.			Pcs - Stück	Profile- Profil(mm)	Length - Länge(mm)
21	Screws/Schrauben/Vis 4X50 mm		55		
22	Nails/Nägel/Clous 2.5x50 mm - For fixing floorboards/ Befestigung bodenbretter/pour lame de terrasse		220		
23	Screws/Schrauben/Vis 4X70 mm		20		
24	Hit block/Schlaghölzer		1	70X114	300 - 400



# Wandplan 1 Terrasse 70.2

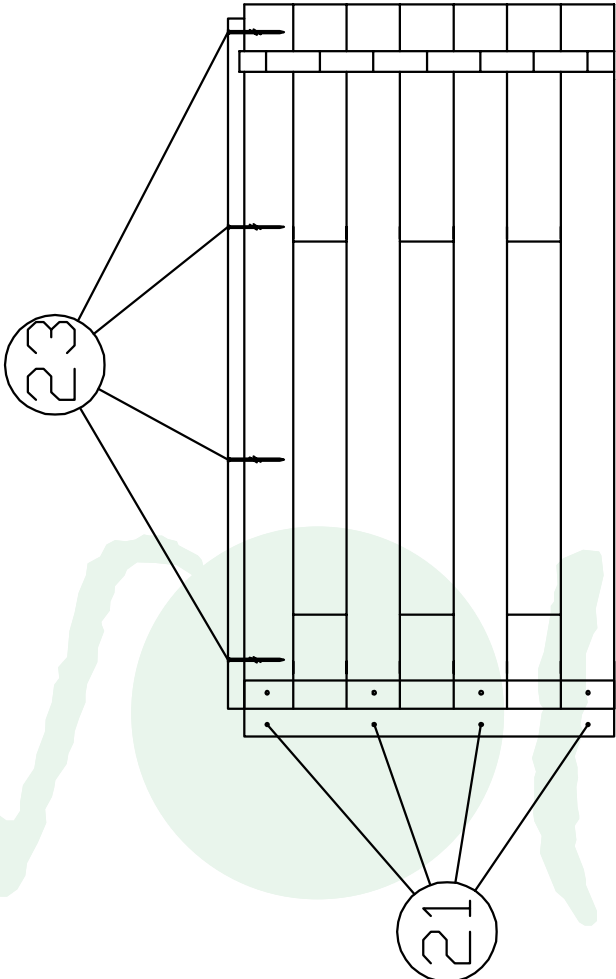
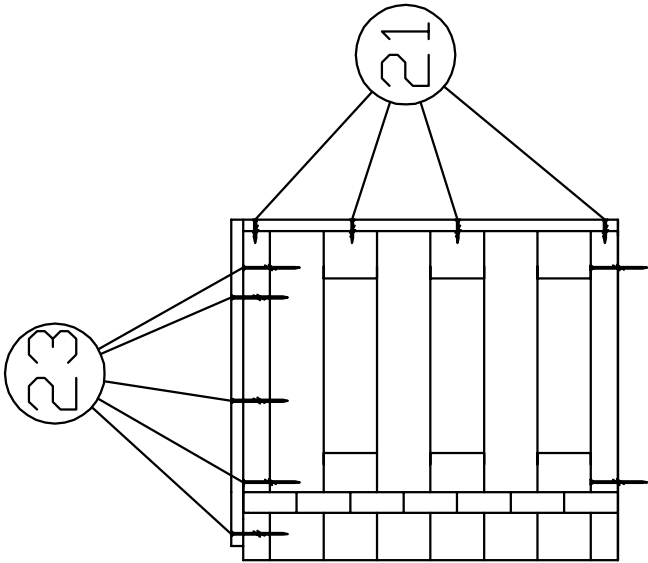

# Wandplan 2 Terrasse 70.2

