

Technische Daten: Art.-Nr.: 580016

Wandaußenmaß: 517 x 607 cm
Bohlenstärke: 70 mm



Kontrolliert durch:

Achtung: Alle angegebenen Maße sind ca.-Maße!

3D-Ansicht 580016

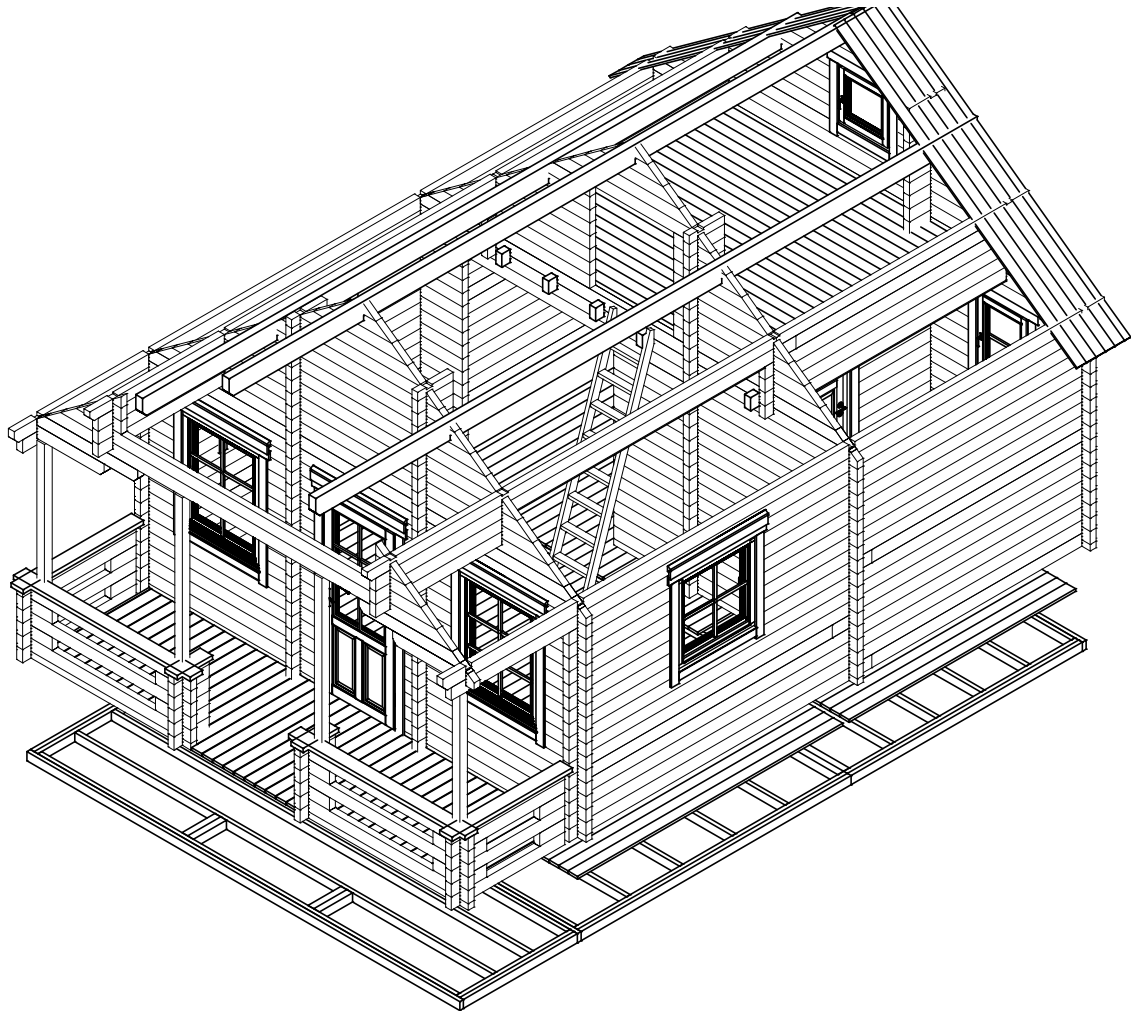

Grundriss 580016

Giebfenster

IV68-1/W105-PC
65x65

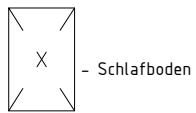
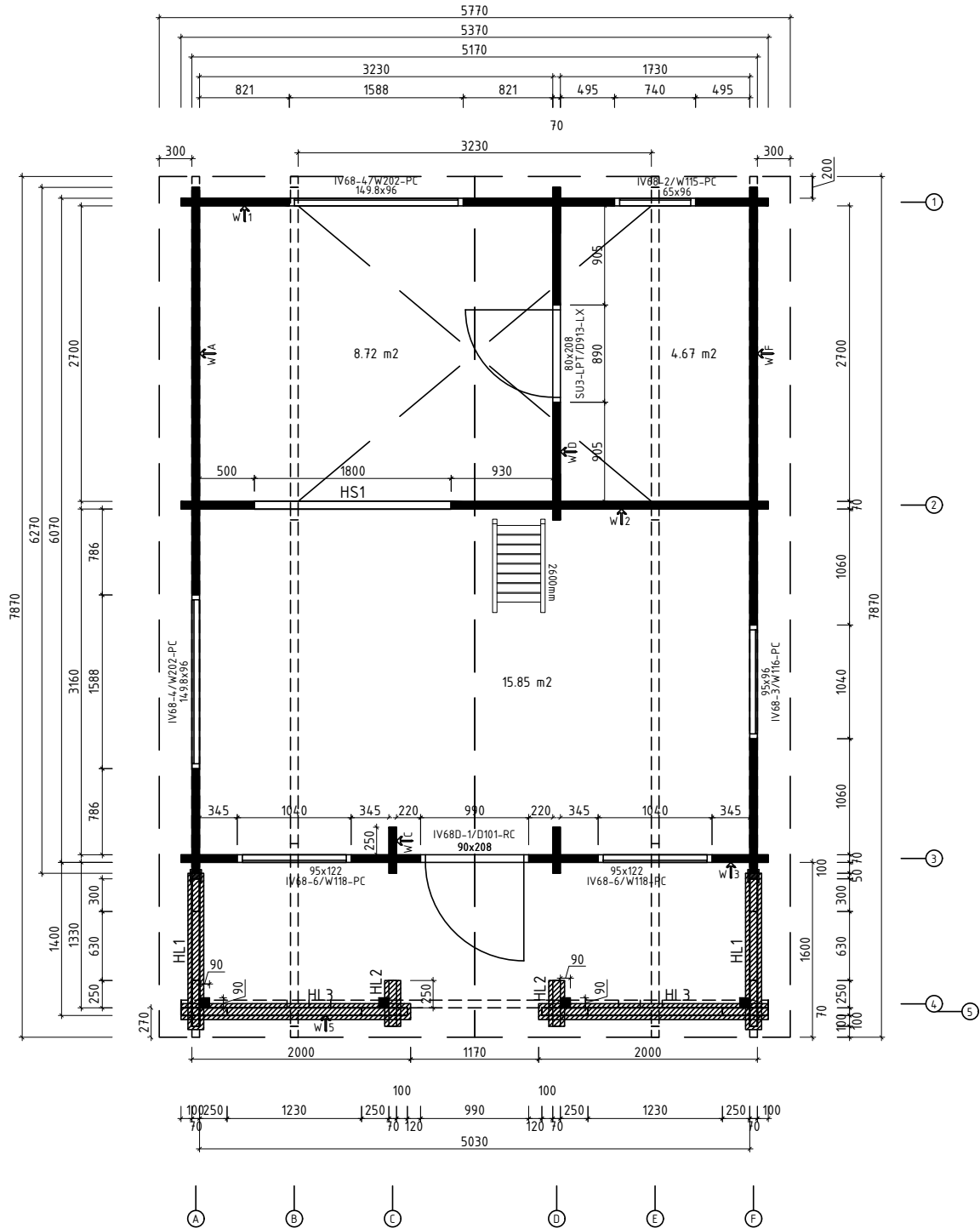

Q6 - Qualitätsklasse für Fenster und Türen
* Fenster und Türen sind mit Sprossen

Lagerholzplan und Fundamentplan 580016

**Wir empfehlen als Fundament für Ihr Gartenhaus eine vollflächig, festgegründete, gepflasterte oder betonierte Fläche.
Wahlweise ist auch ein Punkt- oder Streifenfundament möglich.**

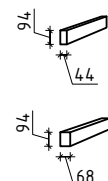
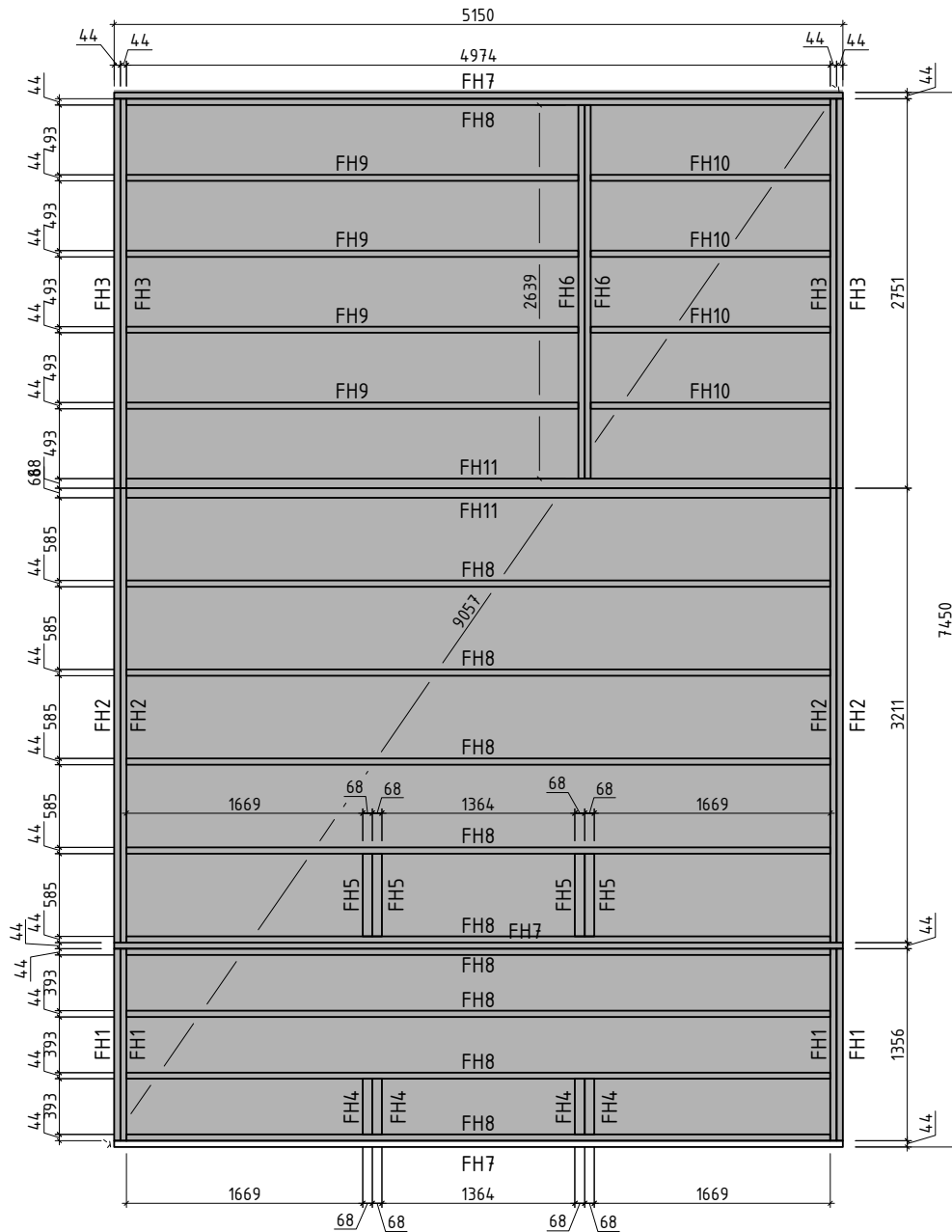











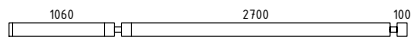
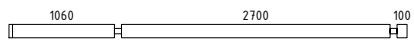

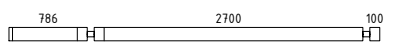
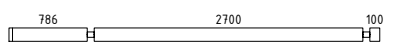
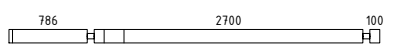
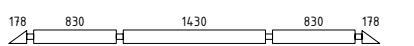
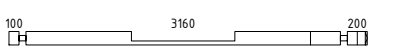
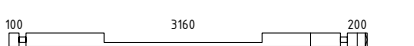
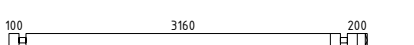
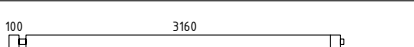
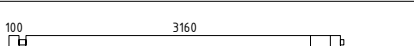
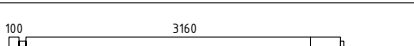
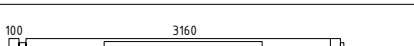
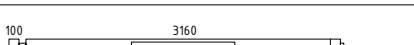
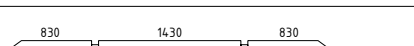
Teilleiste 1

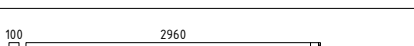
580016

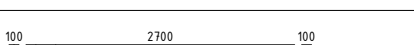
Pos		Stck	Profil (mm)	Länge (mm)
001		1	70x135	5370
002		1	70x135	5370
003		1	70x135	5370
004		1	70x135	5370
005		1	70x135	5370
006		8	70x135	5370
007		1	70x135	5370
008		1	70x68	5370
009		1	70x135	5216
010		1	70x135	5216
011		1	70x135	5216
012		2	70x135	5000
013		1	70x135	4865
014		1	70x112	4865
015		1	70x135	4865
016		1	70x112	4865
017		1	70x135	4844
018		1	70x135	4844
019		1	70x135	4844
020		2	70x135	4765
021		1	70x135	4471
022		1	70x135	4471
023		1	70x135	4471
024		1	70x135	4099
025		1	70x135	4099

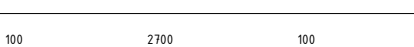

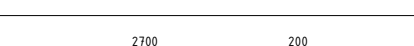





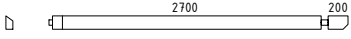
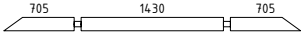
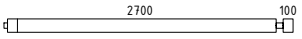
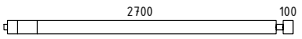
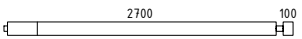
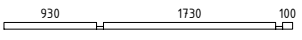
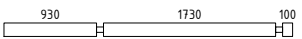
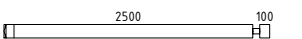
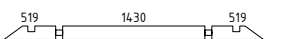
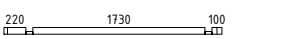

Teilleiste 2

580016

Pos		Stck	Profil (mm)	Länge (mm)
026		1	70x135	4000
027		4	70x135	4000
028		1	70x135	4000
029		1	70x135	3726
030		4	70x135	3726
031		1	70x135	3726
032		1	70x135	3726
033		1	70x135	3600
034		1	70x135	3600
035		2	70x135	3600
036		4	70x135	3365
037		4	70x135	3365
038		4	70x135	3365
039		1	70x135	3365
040		1	70x135	3365
041		1	70x135	3230
042		2	70x135	3140
043		2	70x135	3130
044		7	70x135	3040
045		2	70x135	3040
046		1	70x135	3040
047		1	70x135	3040
048		1	70x112	3005
049		1	70x135	3005
050		1	70x112	3005

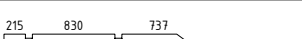
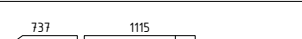
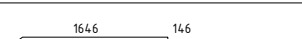

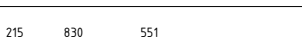

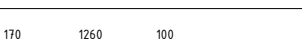
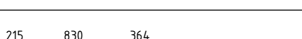

Teilleiste 3

580016

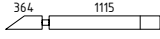
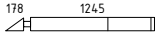
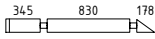
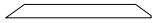
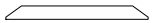
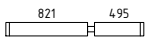
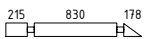
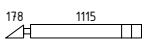
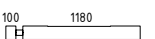
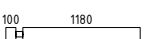
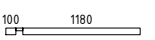
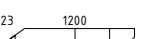
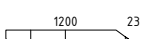
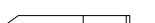
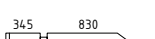
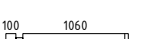
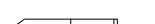
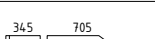
Pos		Stck	Profil (mm)	Länge (mm)
051		1	70x135	3005
052		1	70x135	2981
053		6	70x135	2905
054		8	70x135	2905
055		2	70x135	2905
056		1	70x68	2900
057		15	70x135	2900
058		6	70x135	2670
059		1	70x135	2608
060		2	70x68	2190
061		10	70x135	2190
062		2	70x135	2190
063		2	70x135	2070
064		4	70x135	2070
065		2	70x68	2070
066		1	70x135	1990
067		1	70x135	1922
068		1	70x135	1922
069		1	70x135	1863
070		1	70x135	1863
071		1	70x135	1863
072		1	70x135	1736
073		1	70x135	1736
074		4	70x135	1670
075		1	70x135	1549

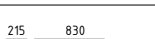

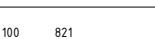
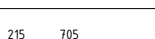



Teilleiste 4

580016

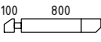
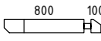
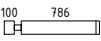
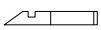
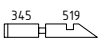
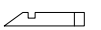
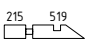
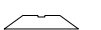
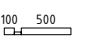
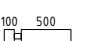
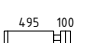
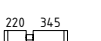
Pos		Stck.	Profil (mm)	Länge (mm)
076		1	70x135	1549
077		1	70x135	1493
078		1	70x135	1493
079		2	70x135	1460
080		1	70x135	1430
081		7	70x135	1386
082		1	70x135	1363
083		1	70x135	1363
084		4	70x135	1350
085		2	70x135	1350
086		2	70x68	1350
087		1	70x135	1293
088		1	70x135	1293
089		1	70x135	1245
090		1	70x135	1245
091		6	70x135	1230
092		1	70x135	1120
093		1	70x135	1120
094		3	70x135	1118
095		1	70x135	1115
096		1	70x135	1115
097		30	70x135	1075
098		7	70x135	991
099		1	70x135	990
100		1	70x135	990

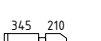
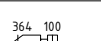
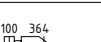
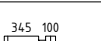

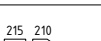
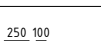

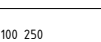
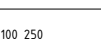
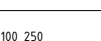
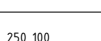











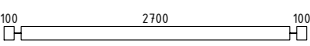





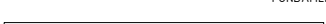



Teilleiste 5

580016

Pos		Stck	Profil (mm)	Länge (mm)
101		1	70x135	970
102		1	70x135	970
103		6	70x135	956
104		1	70x135	934
105		1	70x135	934
106		1	70x135	804
107		1	70x135	804
108		3	70x135	745
109		1	70x68	670
110		15	70x135	670
111		7	70x135	665
112		18	70x135	635
113		1	70x135	625
114		1	70x135	625
115		1	70x135	534
116		1	70x135	534
117		18	70x135	515
118		1	70x135	495
119		1	70x135	495
120		12	70x135	420
121		2	70x89	420
122		26	70x135	420
123		18	70x135	420
124		28	70x135	420
125		2	70x89	420











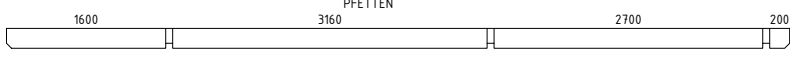
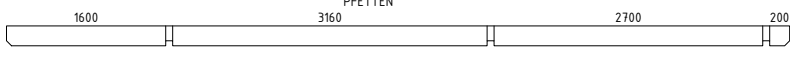
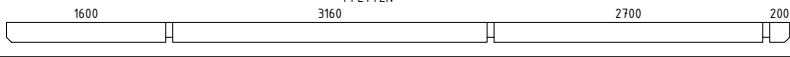

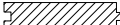

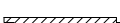





Teilleiste 6

580016

Pos		Stck	Profil (mm)	Länge (mm)
126		2	70x68	420
127		10	70x135	420
128		2	70x135	348
129		4	70x135	300
130		6	70x110	151
131		2	70x117	100
132		6	70x38	53
ÜT1	 _KANT_TALA	5	70x135	3040
FH11	 FUNDAMENTHÖLZER (imprägniert)	2	68x94	4974
FH5	 FUNDAMENTHÖLZER (imprägniert)	4	68x94	585
FH4	 FUNDAMENTHÖLZER (imprägniert)	4	68x94	393
FH7	 FUNDAMENTHÖLZER (imprägniert)	3	44x94	5150
FH8	 FUNDAMENTHÖLZER (imprägniert)	10	44x94	4974
FH2	 FUNDAMENTHÖLZER (imprägniert)	4	44x94	3211
FH9	 FUNDAMENTHÖLZER (imprägniert)	4	44x94	3193
FH3	 FUNDAMENTHÖLZER (imprägniert)	4	44x94	2751
FH6	 FUNDAMENTHÖLZER (imprägniert)	2	44x94	2639
FH10	 FUNDAMENTHÖLZER (imprägniert)	4	44x94	1693
FH1	 FUNDAMENTHÖLZER (imprägniert)	4	44x94	1356
HL3	 HANDLAUF 	✓ 2	145x44	2100
HL1	 HANDLAUF 	✓ 2	145x44	1430
HL2	 HANDLAUF 	✓ 2	145x44	420
HS1	 HOLZSCHWELLE	1	75x28	1800
LE1	 LEISTE	2	58x18	2960
LE2	 LEISTE	2	58x18	2700



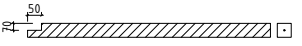





















Teilleiste 7

580016

Pos		Stck.	Profil (mm)	Länge (mm)
DLZ1	 WASSERSCHUTZBRETT	5	18x145	100
PF3	 1	1	80x200	7870
PF1	 1	1	80x200	7870
PF2	 1	1	80x200	7870
	DACHBRETTER 	14.0+2	113x18	3565
	FUSSBODENBRETTER 	45+1	113x28	3155
	FUSSBODENBRETTER 	45	113x28	2695
	SCHLAFBODENBRETTER 	24+1	113x18	3225
	TERRASSENBRETTER (imprägniert) 	10+1	120x28	1395
	TERRASSENBRETTER (imprägniert) 	31	120x28	1325
	ABDECKLEISTEN  ✓		15x28	77,0 lfdm
	FUSSBODENLEISTEN  ✓		14x55	40,0 lfdm
	SCHLAFBODENLEISTEN  ✓		18x40	12,0 lfdm
A70-1	ADAPTER 70  ✓	2	120x106	775
G02-1	GIEBELBRETTER 18x120  35,9° ✓	4	18x120	3643
G01-1	GIEBELBRETTER 18x90  35,9° ✓	4	18x90	3643
G06-1	GIEBELDECKLEISTEN 18x58  ✓	4	18x58	3643
G08-1	GIEBELLEISTEN 18x58  35,9° ✓	4	18x58	3643
T01-1	TRAUFBRETTER 18x90 	4	18x90	3935
T06-1	TRAUFBREITENLEISTEN 18x40  ✓		18x40	17,0 lfdm
GS	Giebelsegment 	2		
TP90-1	STÜTZPFOSTEN 90x90  ✓	2	90x90	2210
TP90-2	STÜTZPFOSTEN 90x90  ✓	2	90x90	2480
TL70-1	T-LEISTE 70 	2	45x70	625
TL70-2	T-LEISTE 70 	4	45x70	760











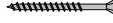
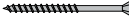
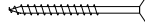
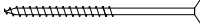







Teilleiste 6

580016

Pos			Stck	Profil (mm)	Länge (mm)
TL7 0-3	T-LEISTE 70		4	45x70	895
TL7 0-4	T-LEISTE 70		4	45x70	1165
TL7 0-5	T-LEISTE 70		2	45x70	1975
TL7 0-6	T-LEISTE 70		2	45x70	2045
UP6-1	U-PROFIL 70	 ✓	2	44x94	1060
UP6-2	U-PROFIL 70	 ✓	2	44x94	1140
UP6-3	U-PROFIL 70	 ✓	1	44x94	1860
UP6-4	U-PROFIL 70	 ✓	2	44x94	2155
ML1	Metallstange		10	D10	1040
ML2	Metallstange		11	D10	770
ML3	Metallstange		4	D10	500
ML4	Metallstange		4	D10	450
ML5	Metallstange		4	D10	360
ML6	Metallstange		6	D10	340
SH	Schlaghölzer		3		
KP-1	DACHPAPPE	 ✓		7,9m-8st.	68,0 lfdm
NG01	DACHPAPPNÄGEL 2.8x15		1264		
NG04	NÄGEL 2.5x50	Dachbretter Schlafbodenbretter		1408	
SR32	SCHRAUBEN 3.0x30	Abdeckleisten 28x15 FBleisten Traufenleiste 40x18		312	
SR37	SCHRAUBEN 3.5x45	LE1, LE2, U-profil Verbindungsstreifen		132	
SR3 550	SCHRAUBEN 3.5x45 C3	Handlauf		26	
SR3 550	SCHRAUBEN 3.5x45 C3	Fenster- und Türleisten		212	
SR4 060	SCHRAUBEN 4.0x60 C3	Wasserleisten		24	
SR4 060	SCHRAUBEN 4.0x60 C3	Wasserschutzbretter		5	

Teilleiste 7

580016

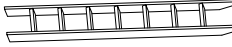
Pos			Stck	Profil (mm)	Länge (mm)
SR4 210	SCHRAUBEN 4.2x55 C2	28mm Fussbodenbretter		546	
SR4 220	SCHRAUBEN 4.2x65 C3	28mm Terrassenbretter		328	
SR55	SCHRAUBEN 5.0x70	Stützpfeosten		40	
SR57	SCHRAUBEN 5.0x100	Fundamenthölzer		180	
HK2	HOLZ-KLOTZEN für verbinden der Wandbohlen (122mm)		8		
VS	VERBINDUNGSSTREIFEN für verbinden der Wandbohlen		20		
VP2	Verstellbare Pfostenstütze M16		4		
KN01	die Fliese mit Nagel 2.0x40 (für Zapfenfüllung)		18		
DBA ND-1	DICHTUNGSBAND (letzte Bohlenkranz Seitenwänder)				16,0 lfdm
KL1	Gewindestange M8		4		2000
KL2	Gewindestange M8		2		792
KL3	Gewindestange M8		2		743
KL4	Gewindestange M8		2		675
KL5	Gewindestange M8		4		517
KL6	Gewindestange M8		4		393
KL7	Gewindestange M8		4		270
KL8	Gewindestange M8		2		247
KV M UT M8	Mutter M8		40		
KV S EIB M8X25	U-Scheibe M8 Ø25		40		
KV MU TJ M8	Befestigungsmutter M8		4		
LMT01	Schlagmutter M8		2		
TR02-1	LEITER 2600mm		1		2600

Teilleiste 6

580016

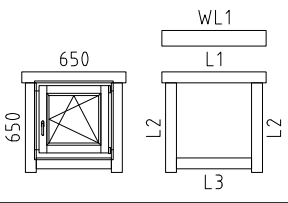
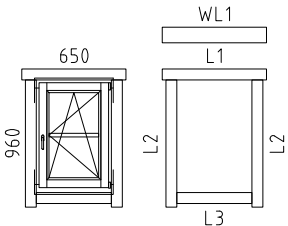
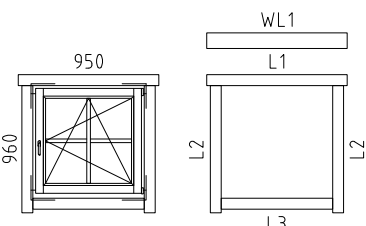
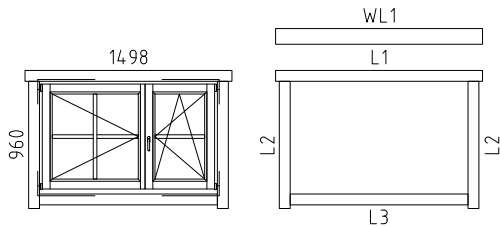
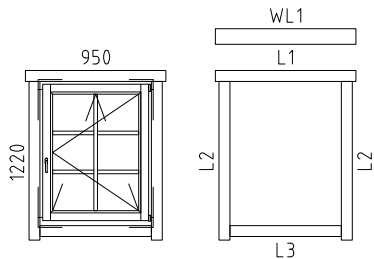
Pos		Stck	Profil (mm)	Länge (mm)
	<p>FENSTER <u>Q6</u> W6-S70P-0XC-06500650</p>  <p>IV68-1/W105-PC</p> <p>L1 18x90 L=860mm 2 Stck. L2 18x90 L=740mm 4 Stck. L3 18x90 L=620mm 2 Stck. ✓ WL1 36x129 L=860mm 1 Stck.</p>	1		
	<p>FENSTER <u>Q6</u> W6-S70P-02C-06500960</p>  <p>IV68-2/W115-PC</p> <p>L1 18x90 L=860mm 2 Stck. L2 18x90 L=1050mm 4 Stck. L3 18x90 L=620mm 2 Stck. ✓ WL1 36x129 L=860mm 1 Stck.</p>	1		
	<p>FENSTER <u>Q6</u> W6-S70P-04C-09500960</p>  <p>IV68-3/W116-PC</p> <p>L1 18x90 L=1160mm 2 Stck. L2 18x90 L=1050mm 4 Stck. L3 18x90 L=920mm 2 Stck. ✓ WL1 36x129 L=1160mm 1 Stck.</p>	1		
	<p>FENSTER <u>Q6</u> W6-D70P-0BC-14980960</p>  <p>IV68-4/W202-PC</p> <p>L1 18x90 L=1710mm 2 Stck. L2 18x90 L=1050mm 4 Stck. L3 18x90 L=1470mm 2 Stck. ✓ WL1 36x129 L=1710mm 1 Stck.</p>	2		
	<p>FENSTER <u>Q6</u> W6-S70P-06C-09501220</p>  <p>IV68-6/W118-PC</p> <p>L1 18x90 L=1160mm 2 Stck. L2 18x90 L=1310mm 4 Stck. L3 18x90 L=920mm 2 Stck. ✓ WL1 36x129 L=1160mm 1 Stck.</p>	2		

Wandplan 1

580016

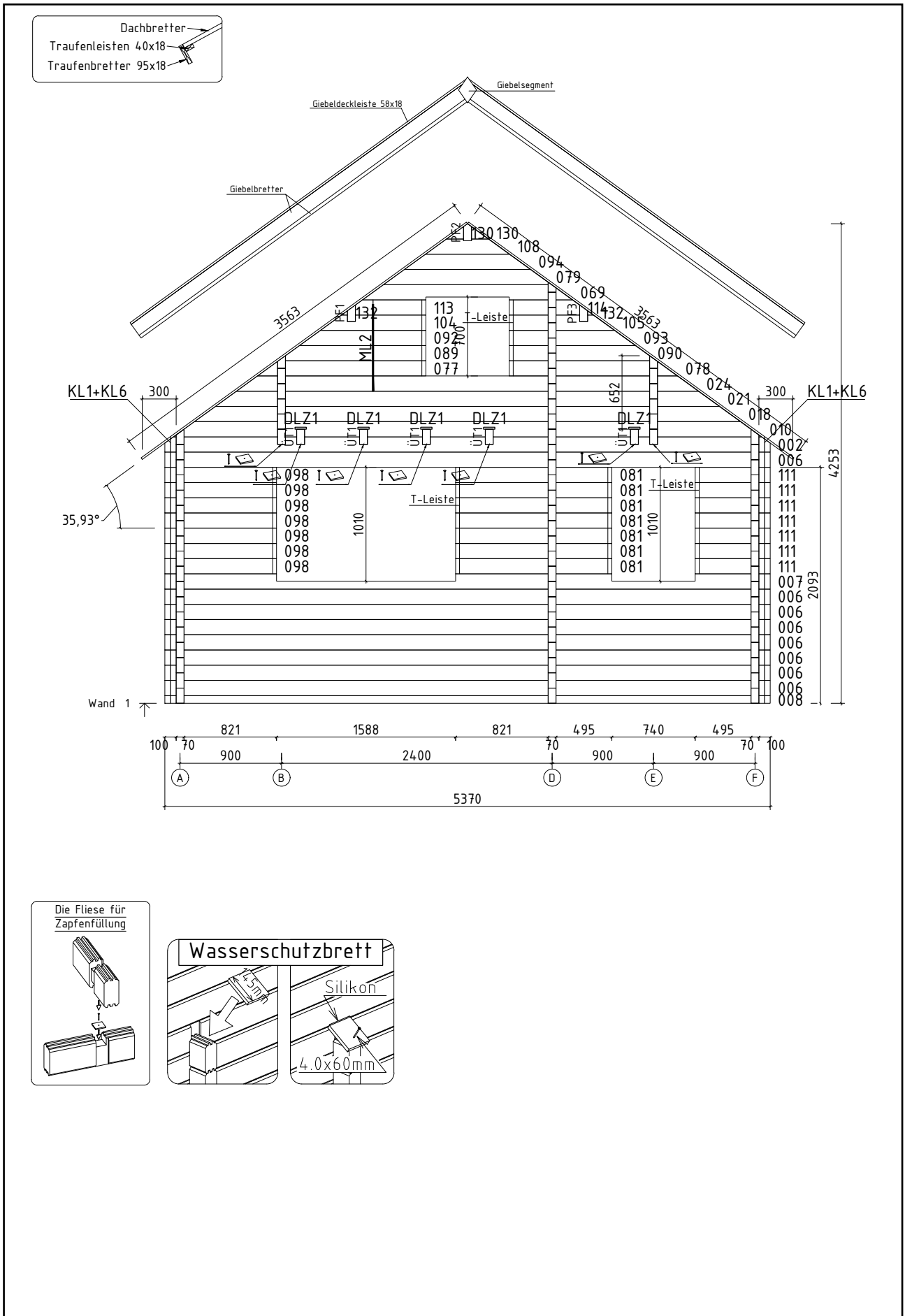

Wandplan 2

580016

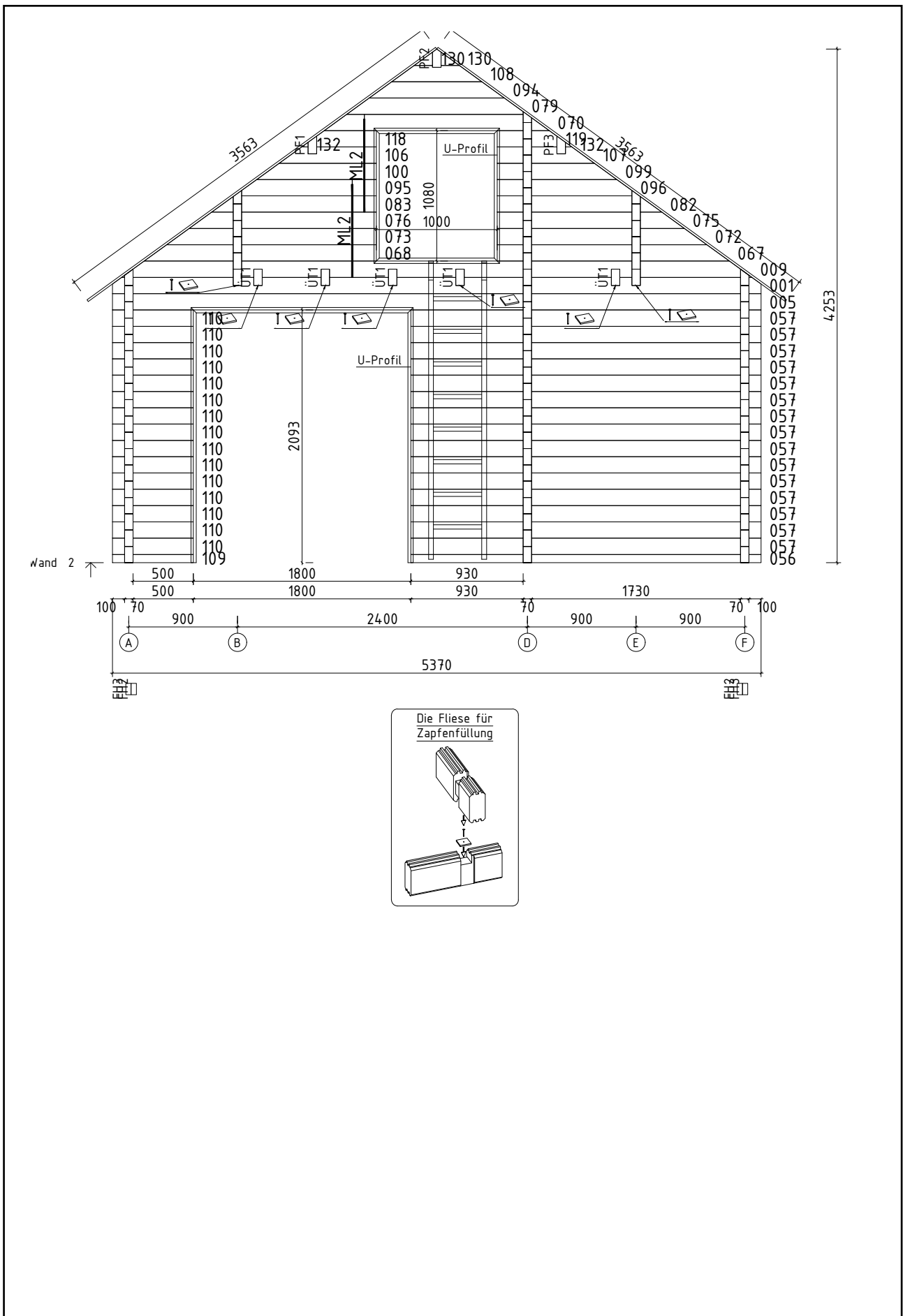

Wandplan 3 580016

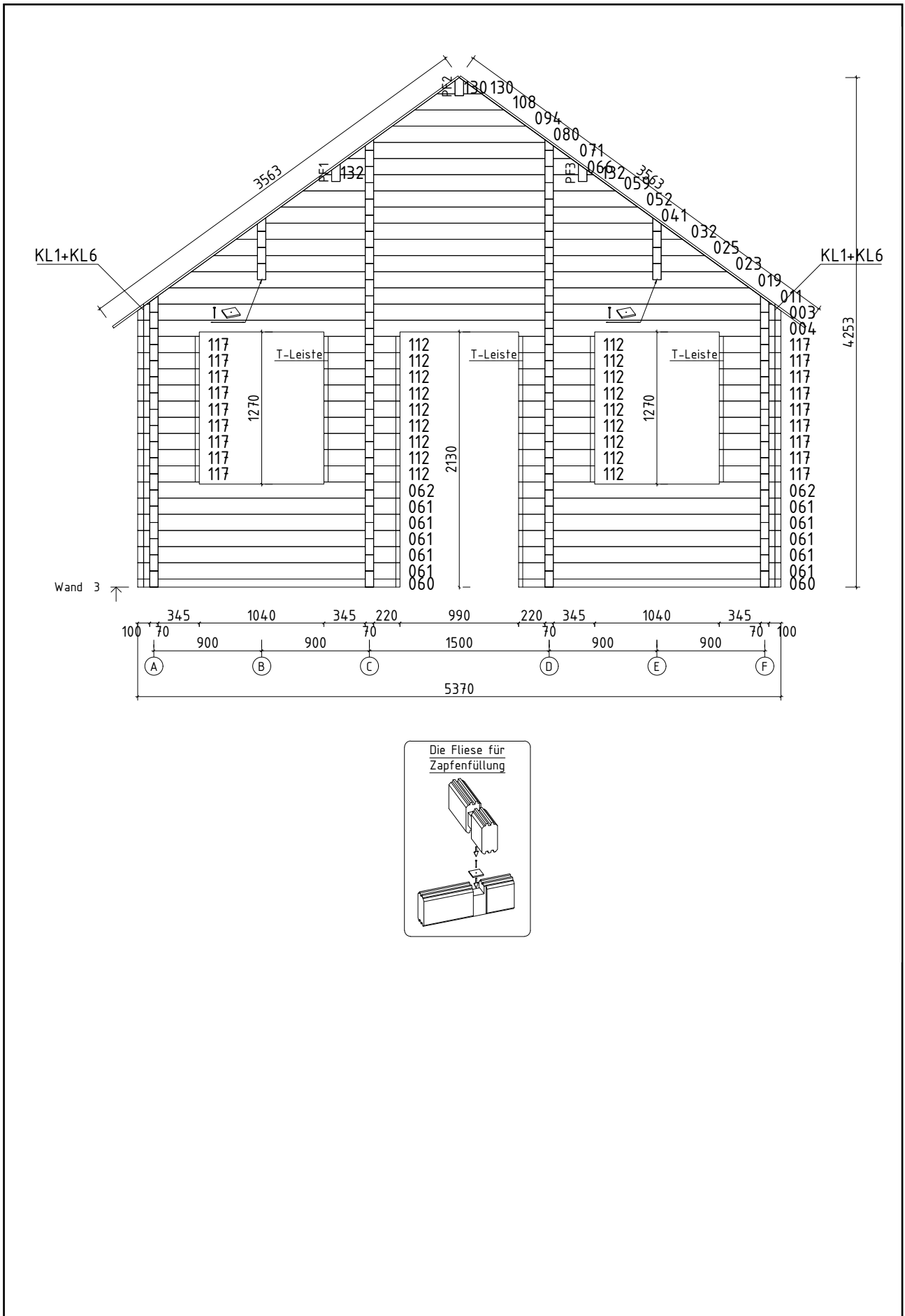

Wandplan 4 580016

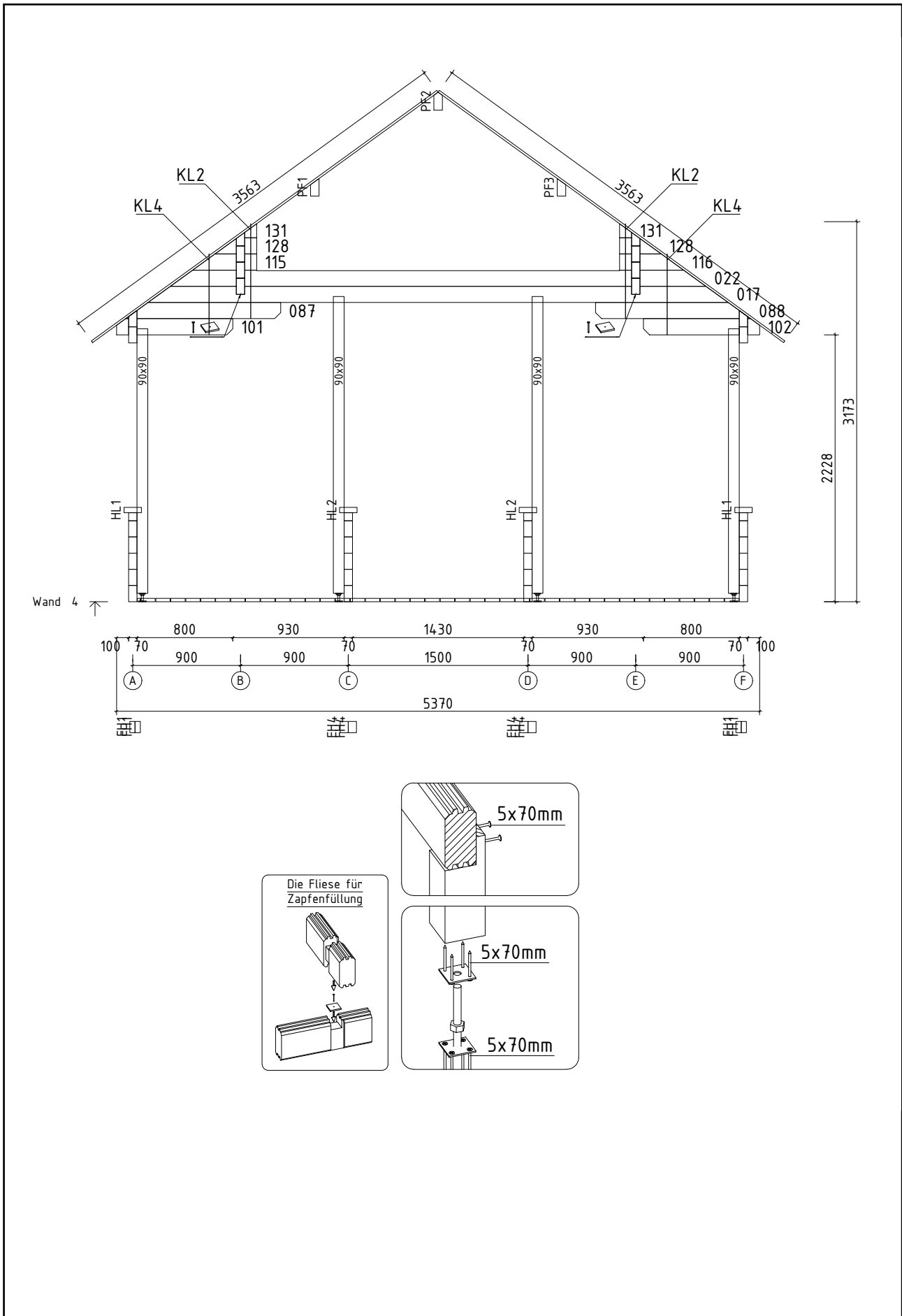

Wandplan 5 580016

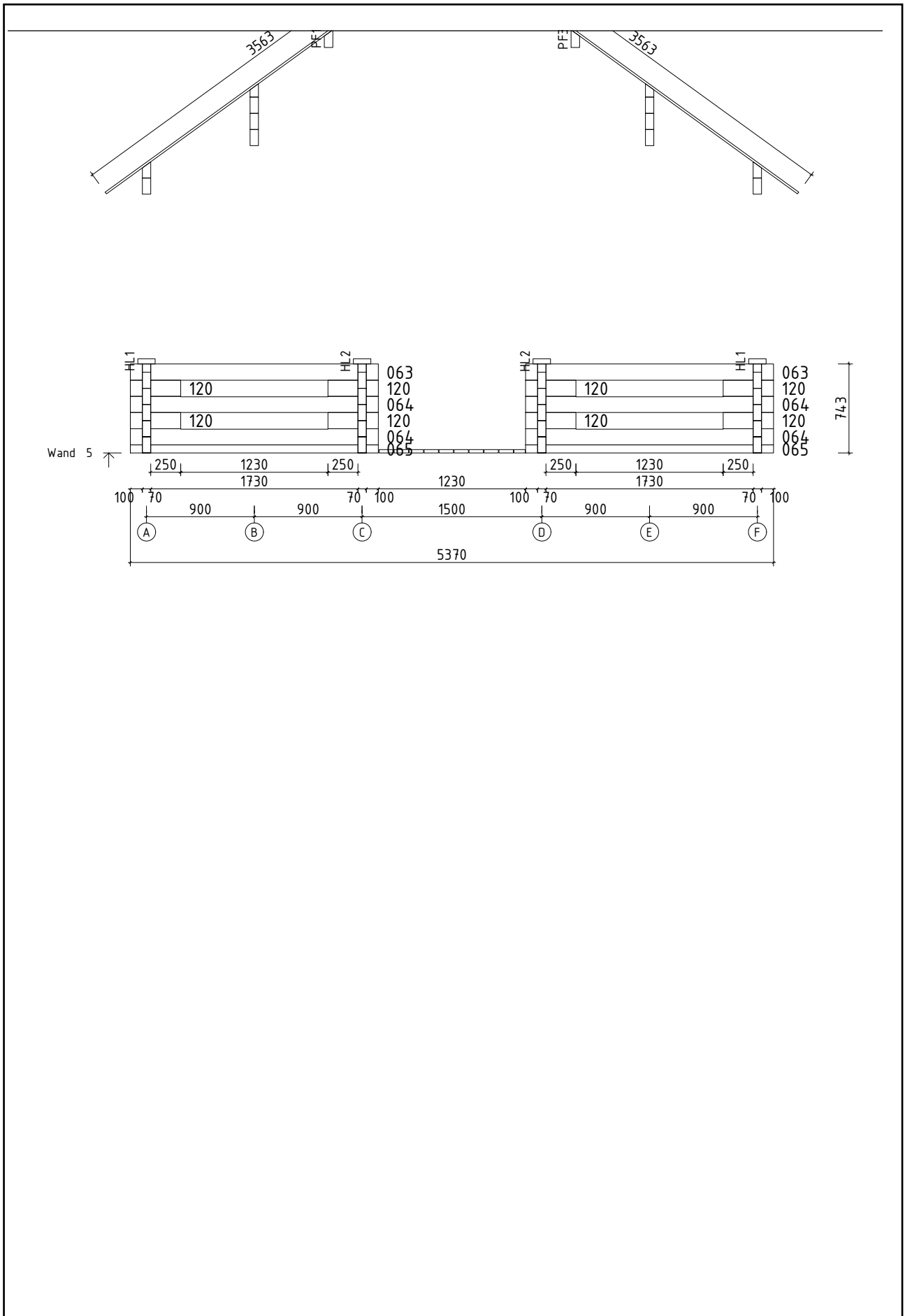

Wandplan A 580016

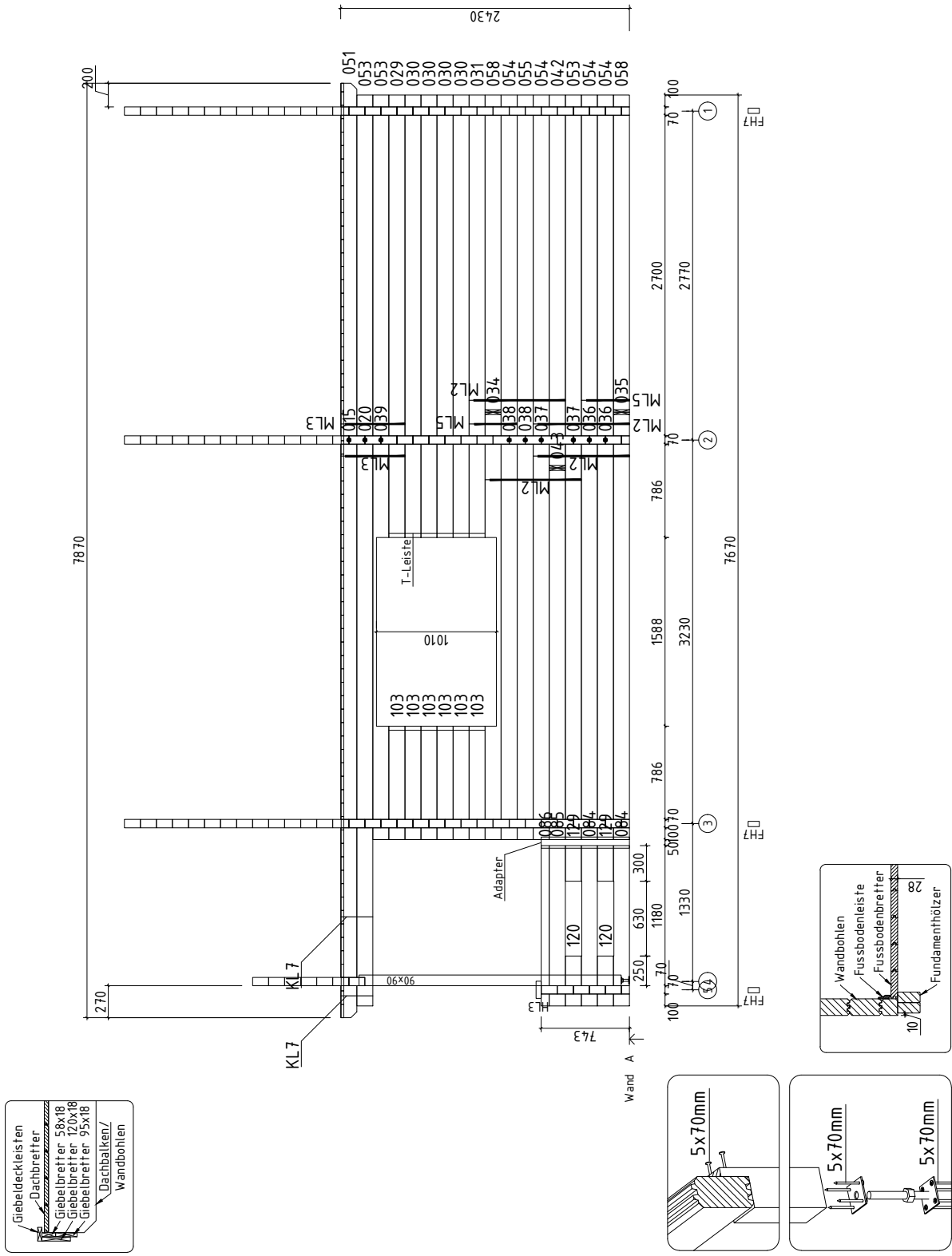

Wandplan B 580016

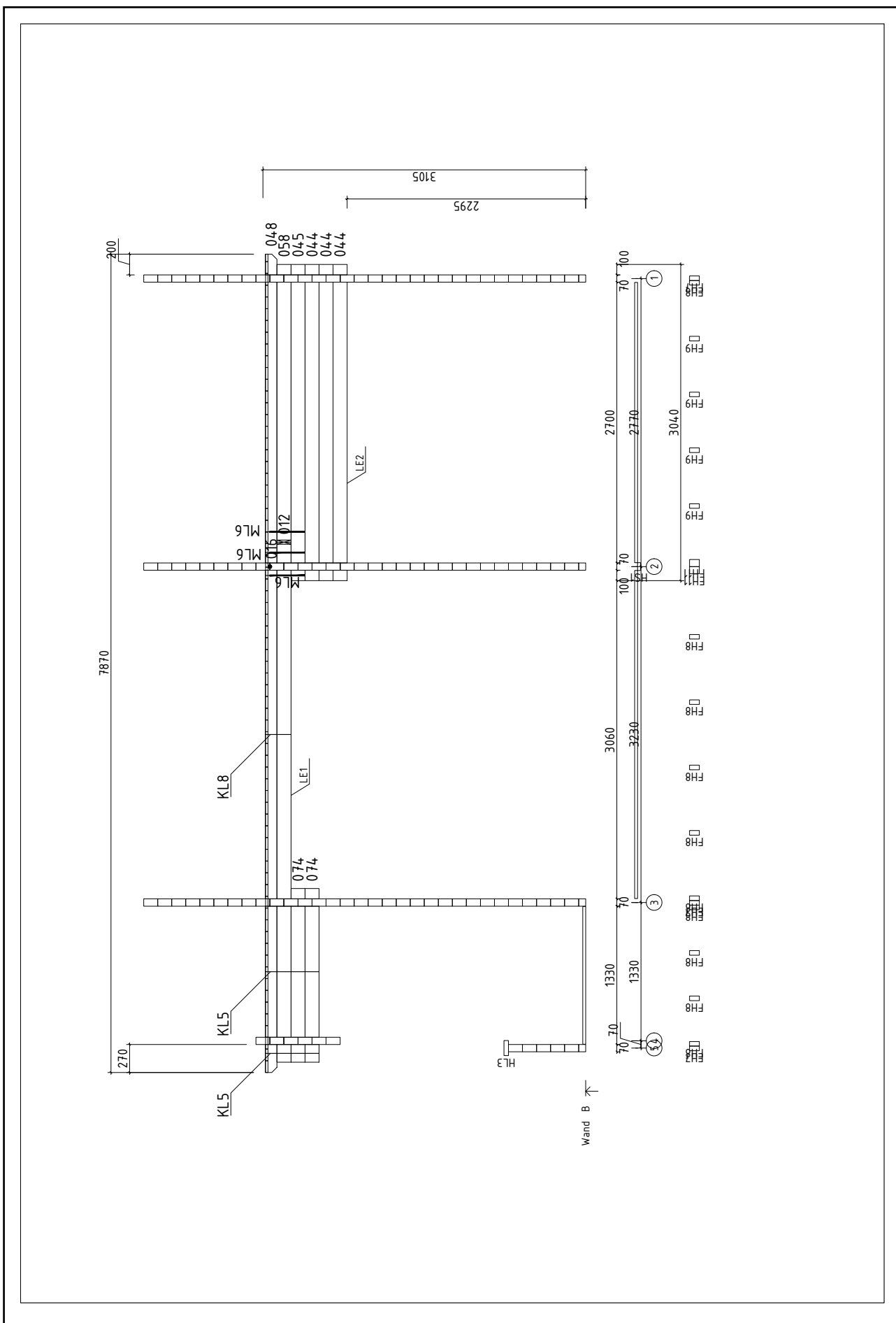

Wandplan C

580016

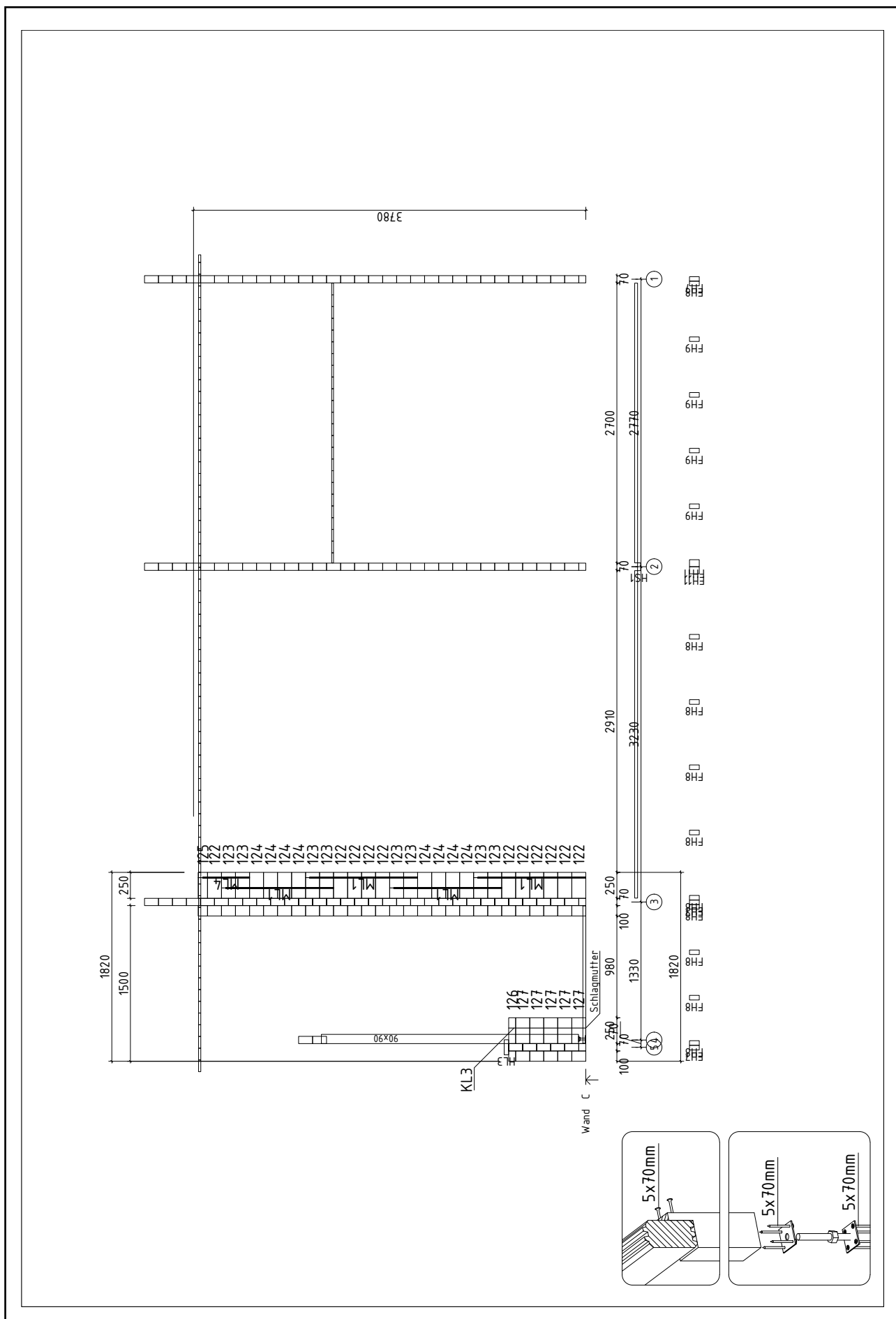

Wandplan D 580016

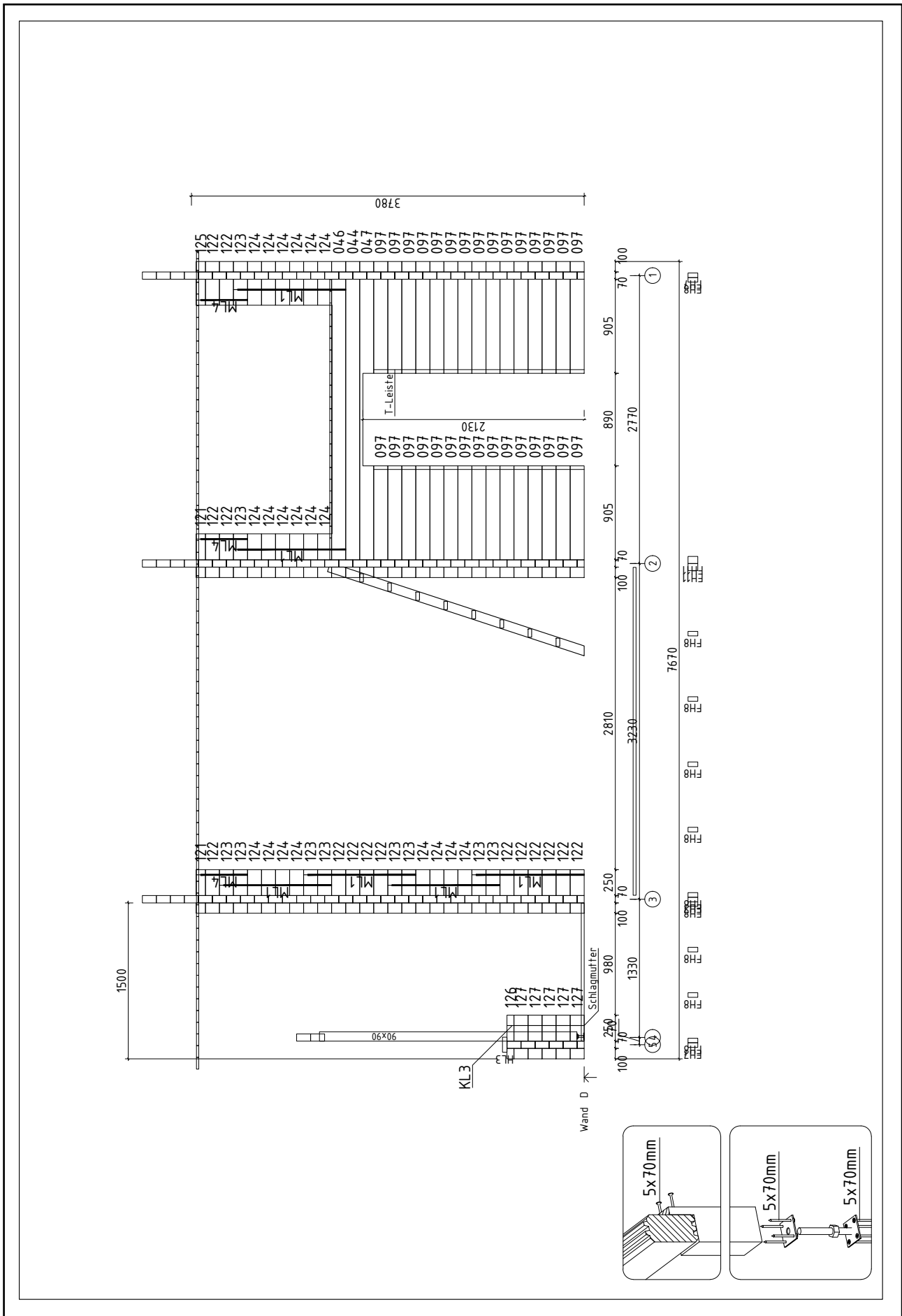

Wandplan E

580016

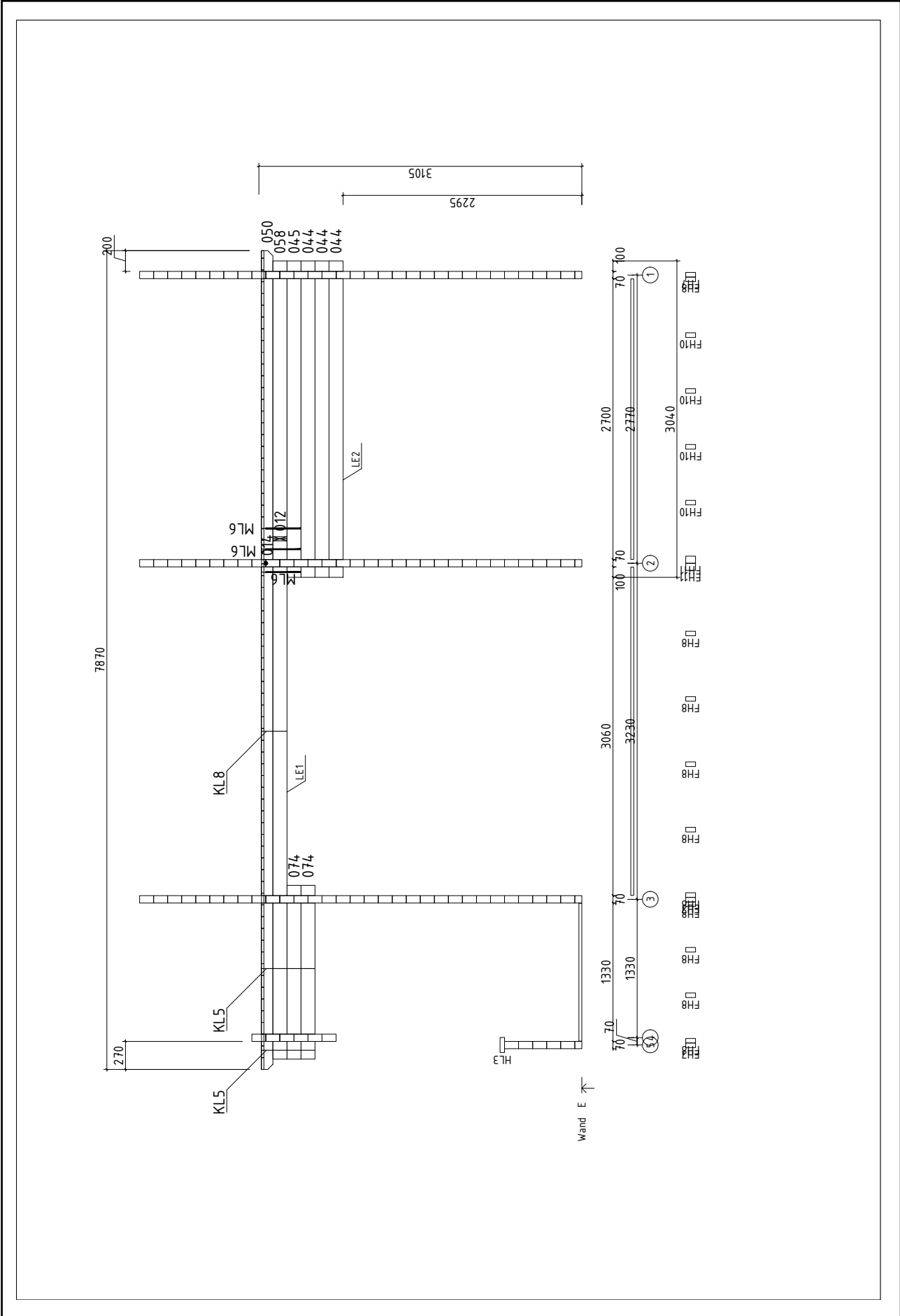

Wandplan F 580016

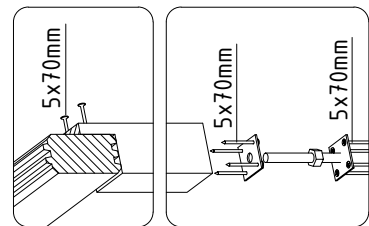
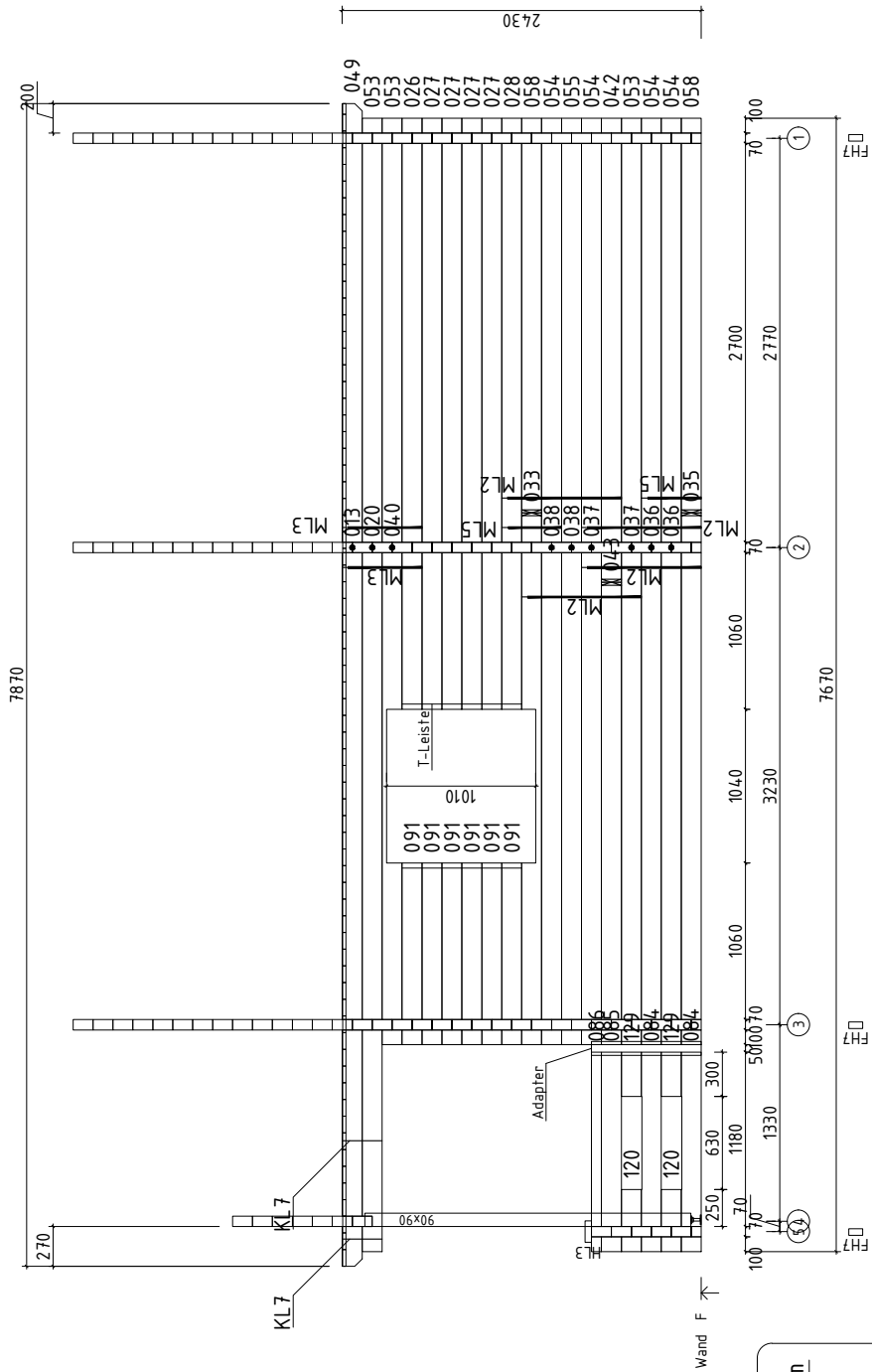

Details 580016

Montageanleitung für T-Leisten / Installing the door and window supports / Tenderliistu paigaldusjuhend.

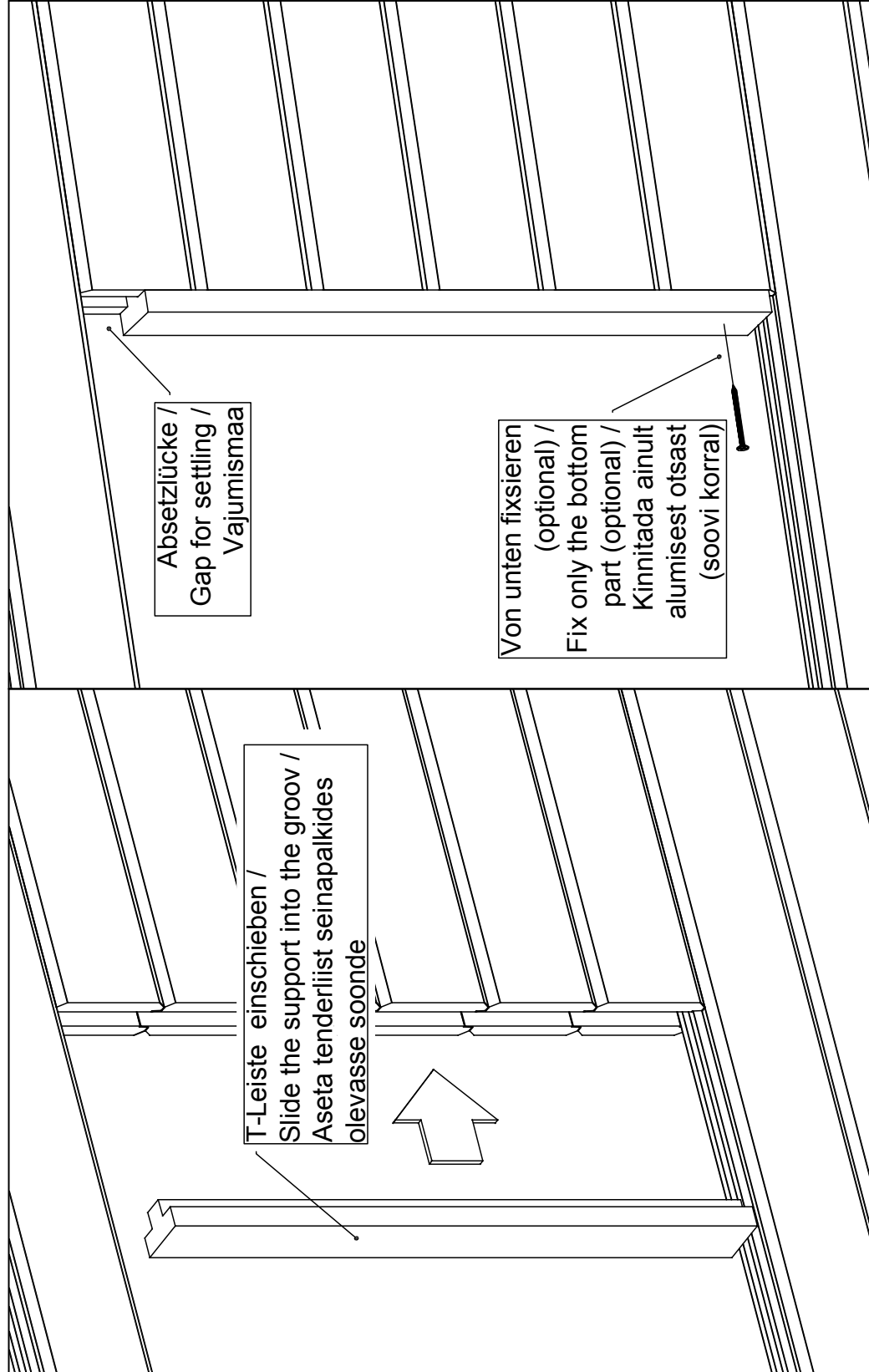

Details

580016

Vihmaliist / Rain strip / Wasserleiste

Q5-Q6

*Silikoon
*Silicon
*Silikon

*Vajumispilu
*Settling gap
*Senkungs spalt

ca 40-50mm

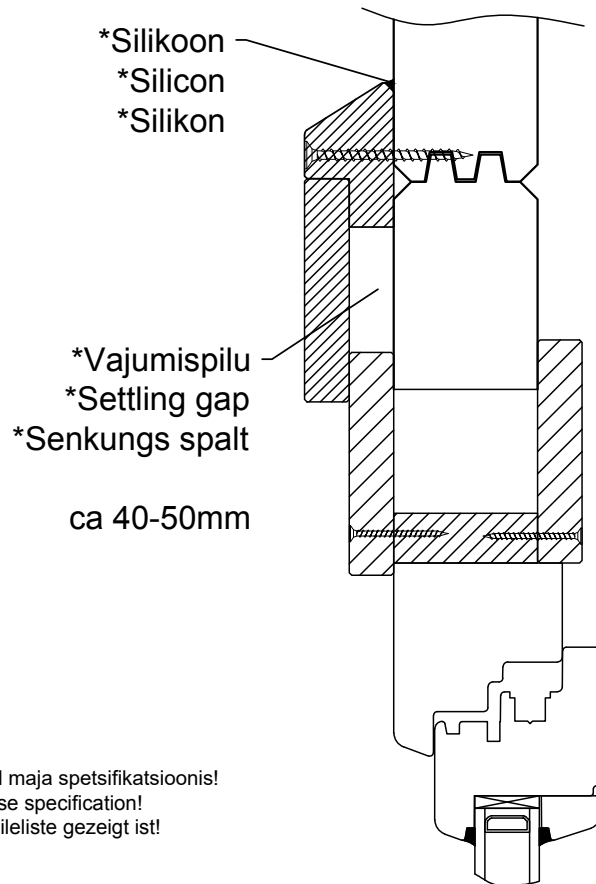
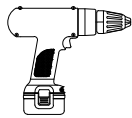

NB!

- Monteerida juhul kui ese on välja toodud maja spetsifikatsioonis!
- Install only if the item is listed in the house specification!
- Nur montieren wenn die Leiste in der Teilleiste gezeigt ist!

Veeplekk / Window sill / Fensterbank

4,2x16

