

Technische Daten: Art.-Nr.: 570240

Wandaußenmaß: 414 x 571 cm
Bohlenstärke: 70 mm



Göteborg 70-C Klassik

Kontrolliert durch:

Achtung: Alle angegebenen Maße sind ca.-Maße!

3D-Darstellung und Grundriss

570240

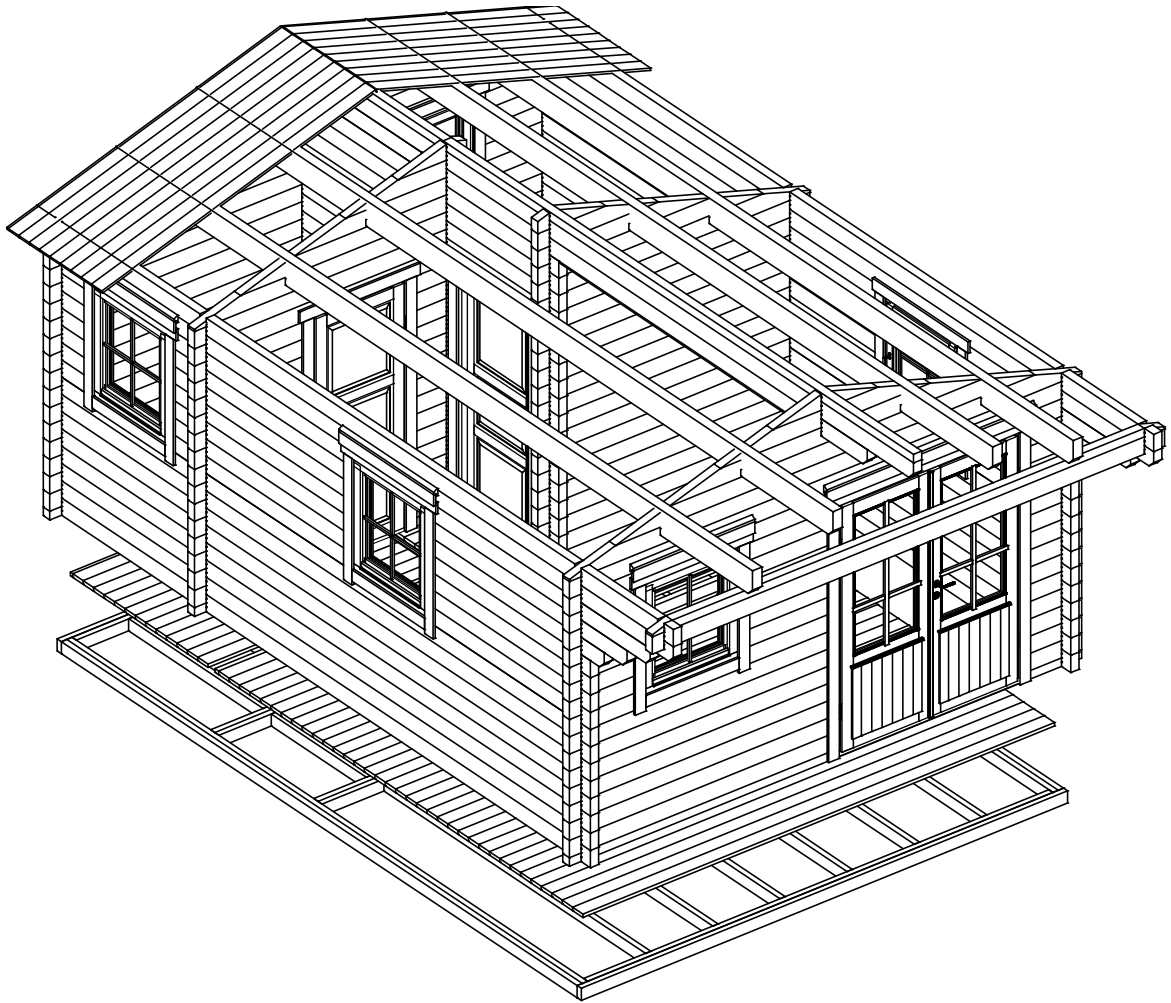

Grundriss 570240

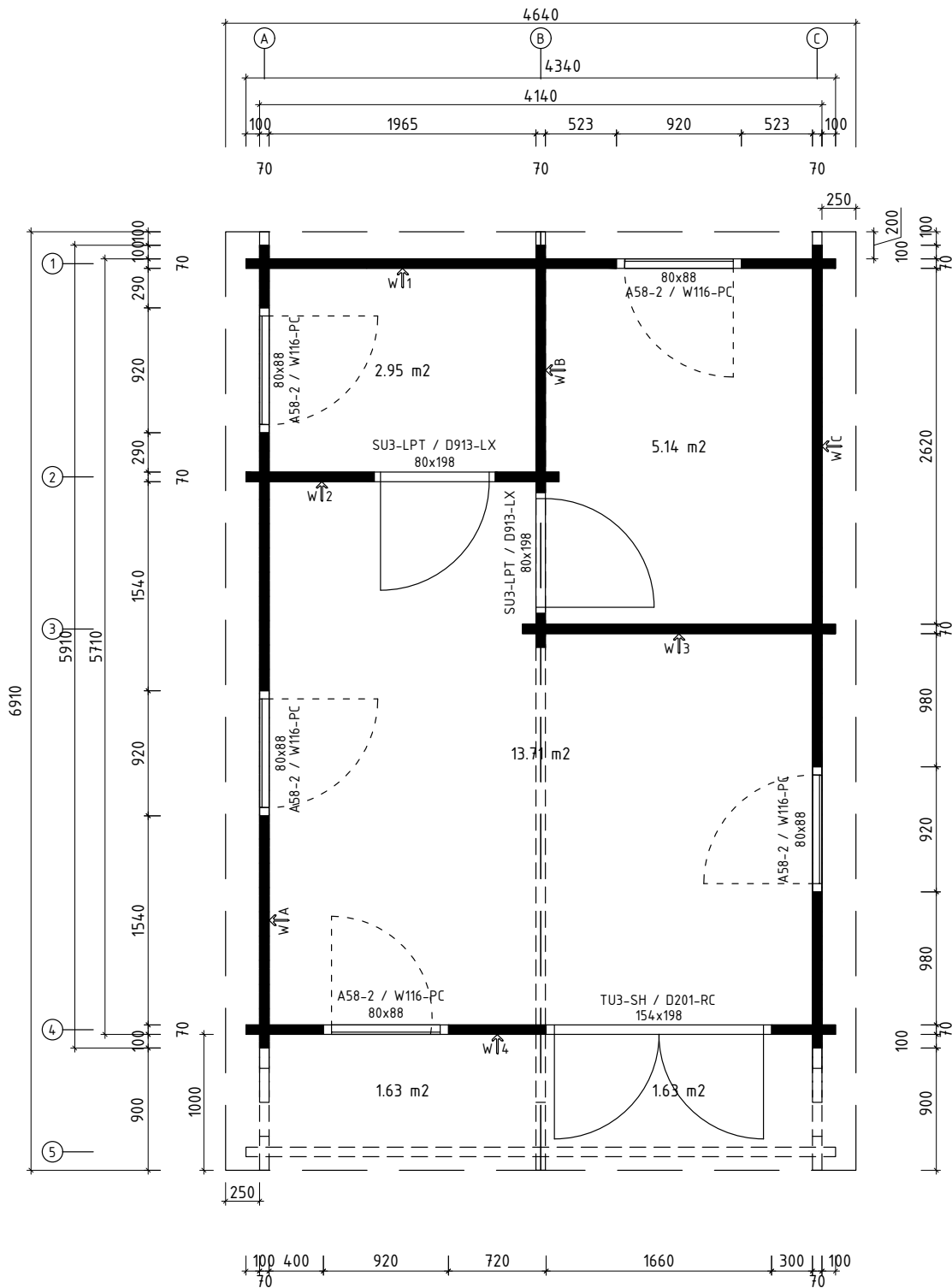

Lagerholzplan und Fundamentplan 570240

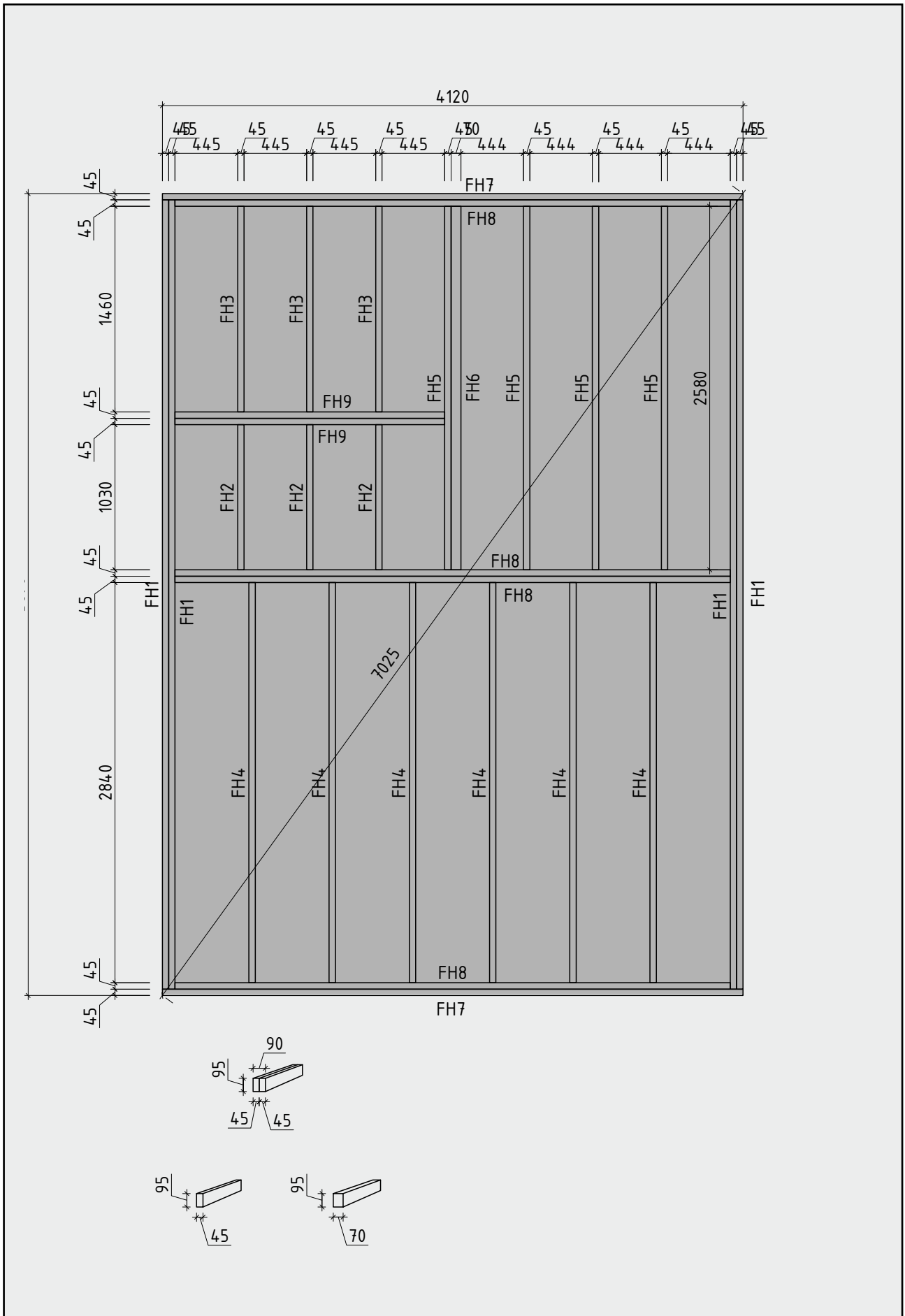





Teileliste 1

570240

Pos		Stck	Profil (mm)	Länge (mm)
001		8	70x135	5910
002		8	70x135	5910
003		1	70x135	5105
004		1	70x67	5105
005		1	70x135	5105
006		1	70x135	5105
007		1	70x135	4840
008		1	70x68	4340
009		1	70x135	4340
010		1	70x135	4340
011		2	70x135	4340
012		1	70x135	4340
013		8	70x135	4340
014		1	70x135	4340
015		1	70x135	4340
016		1	70x68	4340
017		1	70x135	3985
018		1	70x135	3985
019		1	70x135	3840
020		6	70x135	3840
021		3	70x135	2960
022		1	70x135	2960
023		1	70x135	2925
024		1	70x135	2925
025		6	70x135	2728

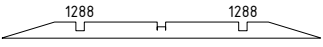
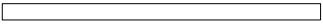
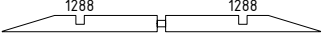
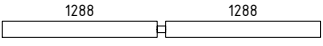

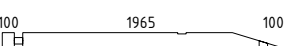
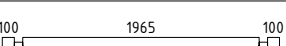
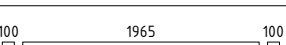
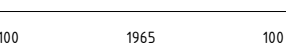
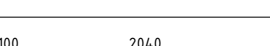
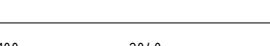
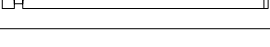
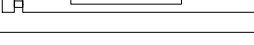
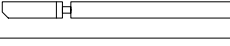
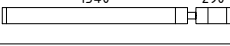
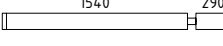
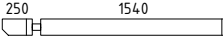
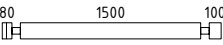
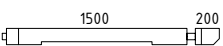
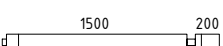
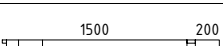
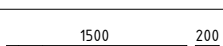

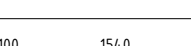
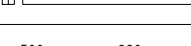





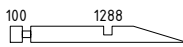
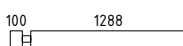
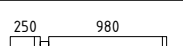

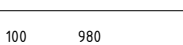
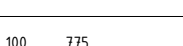
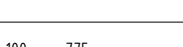

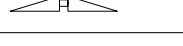
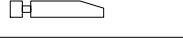
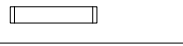
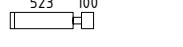

Teileliste 2

570240

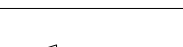
Pos		Stck	Profil (mm)	Länge (mm)
026		1	70x135	2647
027		1	70x135	2647
028		1	70x135	2647
029		1	70x135	2647
030		1	70x135	2360
031		2	70x135	2305
032		17	70x135	2305
033		1	70x68	2305
034		1	70x135	2305
035		1	70x68	2210
036		7	70x135	2210
037		1	70x135	2210
038		1	70x135	2110
039		1	70x135	1900
040		6	70x135	1900
041		1	70x135	1860
042		15	70x135	1820
043		1	70x135	1805
044		1	70x135	1805
045		1	70x67	1805
046		1	70x135	1805
047		1	70x135	1800
048		4	70x135	1710
049		1	70x135	1550
050		1	70x135	1470



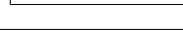
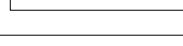
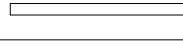







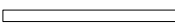









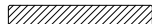



Teileliste 3

570240

Pos		Stck	Profil (mm)	Länge (mm)
051		2	70x135	1458
052		2	70x135	1458
053		1	70x135	1300
054		2	70x135	1283
055		4	70x135	1150
056		1	70x68	945
057		14	70x135	945
058		2	70x124	889
059		2	70x135	777
060		6	70x135	720
061		6	70x135	693
062		2	70x124	579
063		6	70x135	570
064		2	70x68	470
065		28	70x135	470
066		7	70x135	460
067		6	70x117	384
068		15	70x135	250
069		6	70x54	177
FH6	FUNDAMENTHÖLZER (imprägniert) 	1	70x95	2580
FH1	FUNDAMENTHÖLZER (imprägniert) 	4	45x95	5600
FH7	FUNDAMENTHÖLZER (imprägniert) 	2	45x95	4120
FH8	FUNDAMENTHÖLZER (imprägniert) 	4	45x95	3940
FH4	FUNDAMENTHÖLZER (imprägniert) 	6	45x95	2840
FH5	FUNDAMENTHÖLZER (imprägniert) 	4	45x95	2580











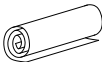
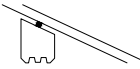



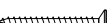





Teilleiste 4

570240

Pos		Stck	Profil (mm)	Länge (mm)
FH9	FUNDAMENTHÖLZER (imprägniert) 	2	45x95	1914
FH3	FUNDAMENTHÖLZER (imprägniert) 	3	45x95	1460
FH2	FUNDAMENTHÖLZER (imprägniert) 	3	45x95	1030
LE1	LEISTE 	1	58x18	2780
PF2	PFETTEN 	2	80x200	6910
PF1	PFETTEN 	2	80x200	6910
	DACHBRETTER 	124+1	113x18	2425
	FUSSBODENBRETTER 	26+1	113x28	3995
	FUSSBODENBRETTER 	48	113x28	1960
	ABDECKLEISTEN  ✓		15x28	46.0lfm
	FUSSBODENLEISTEN  ✓		14x55	35.0lfm
G02-1	GIEBELBRETTER 18x120  16.9° ✓	4	18x120	2505
G01-1	GIEBELBRETTER 18x95  16.9° ✓	4	18x95	2505
G06-1	GIEBELDECKLEISTEN 18x58  ✓	4	18x58	2505
G08-1	GIEBELBRETTER 18x58  16.9° ✓	4	18x58	2505
T01-1	TRAUFENBRETTER 18x95 	4	18x95	3455
T06-1	TRAUFENLEISTEN 18x40  ✓		18x40	14.0lfm
TL70-1	T-LEISTE 70 	4	45x70	760
TL70-2	T-LEISTE 70 	6	45x70	895
TL70-3	T-LEISTE 70 	4	45x70	1905
TL70-4	T-LEISTE 70 	2	45x70	1975
GS	Giebelsegment 	2		
SH	Schlaghölzer 	3		
HK2	HOLZ-KLOTZEN für verbinden der Wandbohlen (122mm) 	1		
VS	VERBINDUNGSSSTREIFEN für verbinden der Wandbohlen 	6		

Teileliste 5

570240

Pos			Stck	Profil (mm)	Länge (mm)
KP-1	DACHPAPPE		✓	6,91m-6st	42.5lfm
DBA ND-1	DICHTUNGSBAND (letzte Bohlenkranz Seitenwänder)		✓	6,91m-2st	14.0lfm
NG01	DACHPAPPNÄGEL 2.8x15		690		
NG04	NÄGEL 2.5x50 Dachbretter		992		
SR32	SCHRAUBEN 3.0x30 Fussbodenleisten, Abdeckleisten Traufenleiste 4.0x18		190		
SR37	SCHRAUBEN 3.5x45 Leiste LE1, Verbindungsstreifen Türleiste SU3-LPT		75		
SR3 550	SCHRAUBEN 3.5x45 C3 Fenster- und Türleisten		14.4		
SR3 550	SCHRAUBEN 3.5x45 C3 Giebelbretter		72		
SR3 550	SCHRAUBEN 3.5x45 C3 Giebeldeckleisten		24		
SR3 550	SCHRAUBEN 3.5x45 C3 Giebelsegment		4		
SR3 550	SCHRAUBEN 3.5x45 C3 Traufenbretter		28		
SR4 060	SCHRAUBEN 4.0x60 C3 Wasserleisten		19		
SR4 210	SCHRAUBEN 4.2x55 C2 28mm Fussbodenbretter		4.78		
SR57	SCHRAUBEN 5.0x100 Fundamenthölzer		116		
KL1	Gewindestange M8		4		2000
KL2	Gewindestange M8		2		338
KL3	Gewindestange M8		4		325
KV M UT M8	Mutter M8		12		
KV S EIB M8X25	U-Scheibe M8 Ø25		12		
KV MU TJ M8	Befestigungsmutter M8		4		
ML1	Metallstange		3	D10	430
ML2	Metallstange		4	D10	360

Teileliste 6

570240

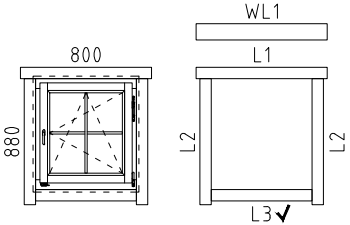
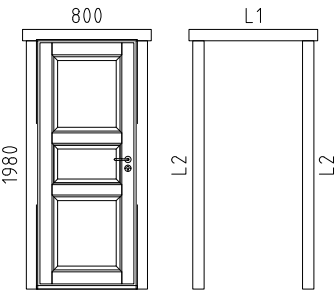
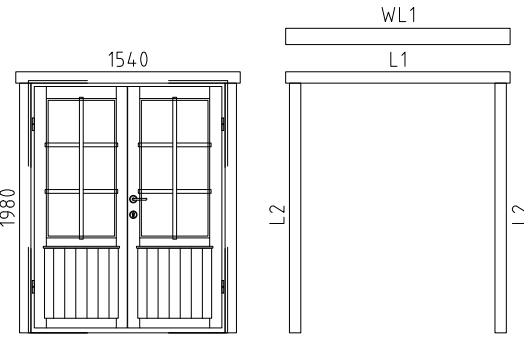
Pos		Stck	Profil (mm)	Länge (mm)
	<p>FENSTER Q4 W4-S70P-04C-08000880</p>  <p>A58-2 / W116-PC</p> <p>L1 18x90 L=1040mm 2x L2 18x90 L=1000mm 4x L3 18x90 L=800mm 2x ✓ WL1 36x129 L=1040mm 1x</p>	5		
	<p>TÜR D0-I70L-XXX-08001980</p>  <p>SU3_LPT / D913-LX</p> <p>L1 18x90 L=1020mm 2 Stck. L2 18x90 L=1970mm 4 Stck. ✓</p> <p>DIN 2xlinks</p>	2		
	<p>TÜR Q4 D4-D70R-56C-15401980</p>  <p>TU3-SH / D201-RC</p> <p>L1 18x90 L=1780mm 2 Stck. L2 18x90 L=1980mm 4 Stck. ✓ WL1 36x129 L=1780mm 1 Stck.</p> <p>DIN rechts</p>	1		
	<p>✓ - bitte selber anpassen (falls nötig!)</p>			

Wandplan 1 und 2

570240

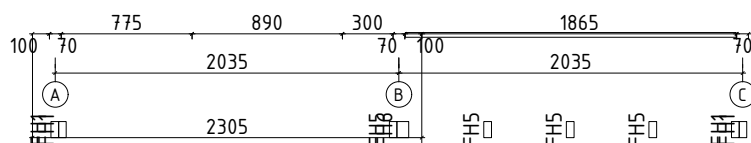
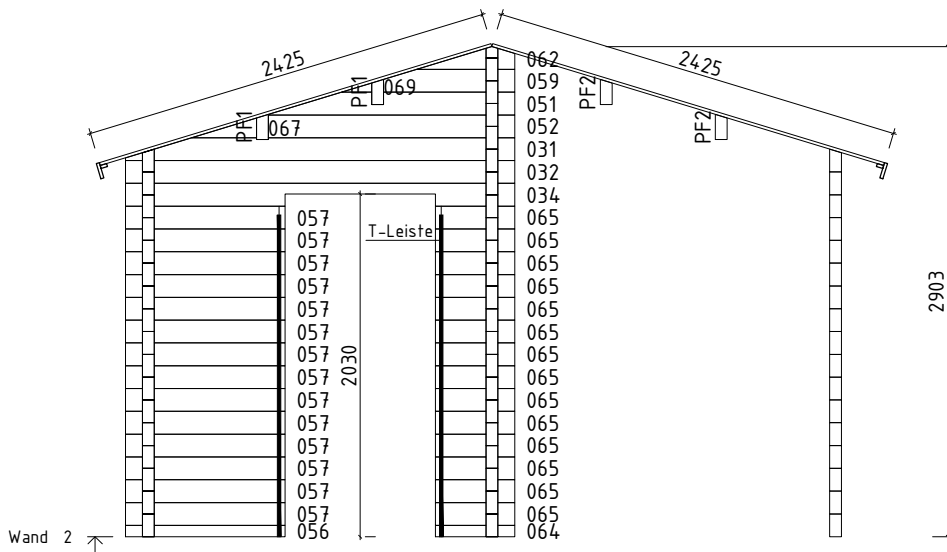
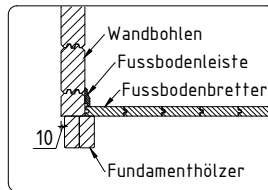
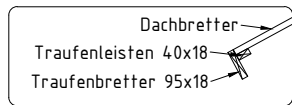
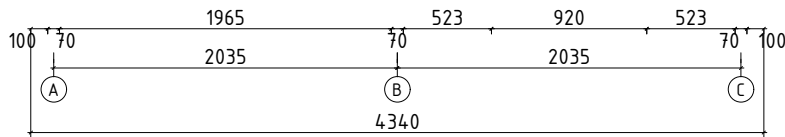
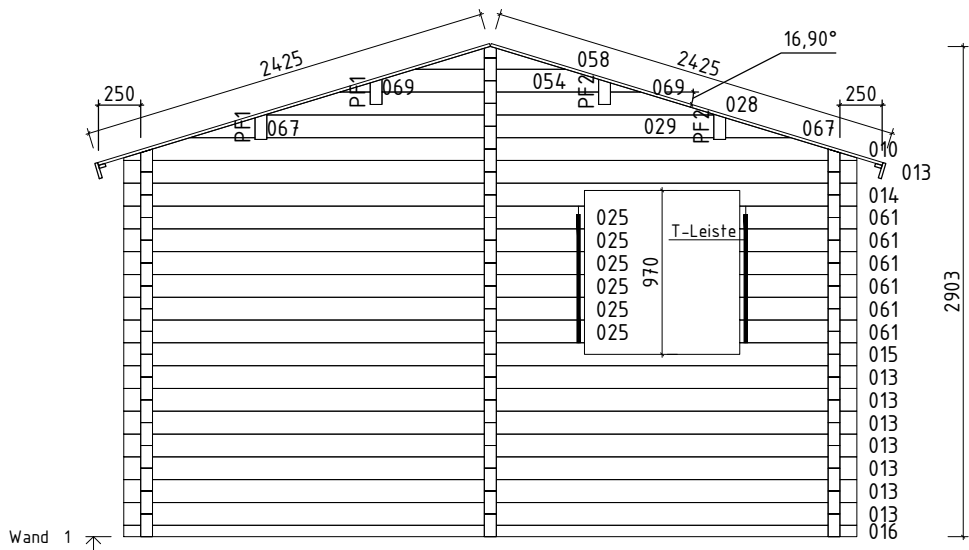

Wandplan 3 und 4 570240

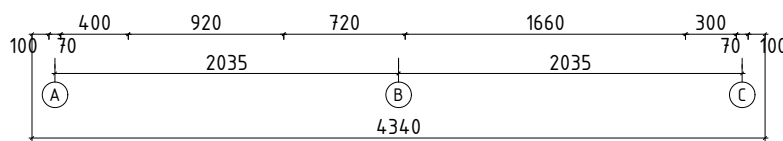
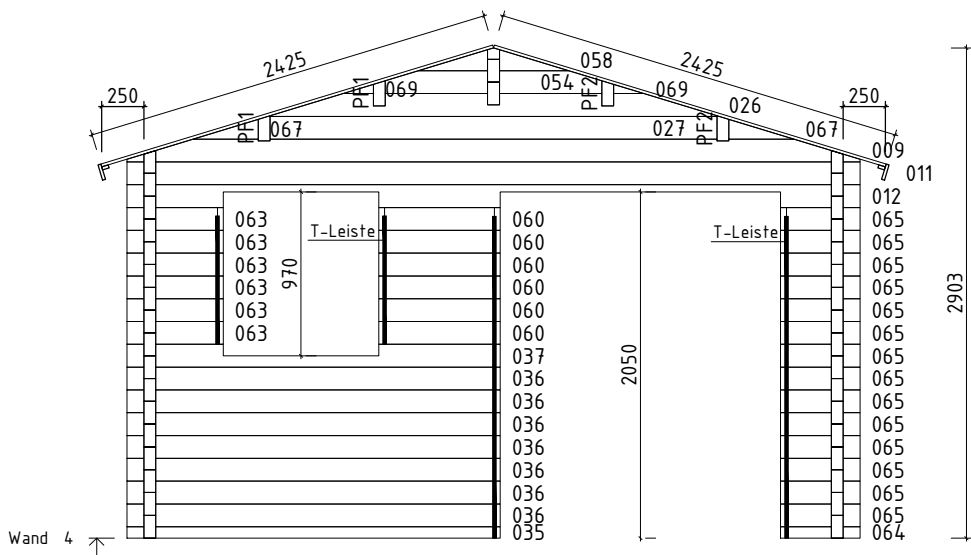
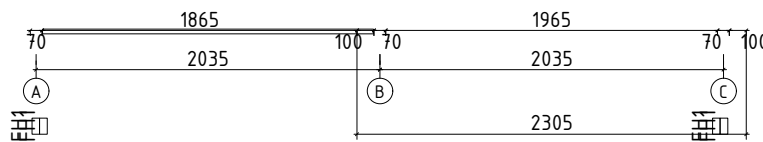
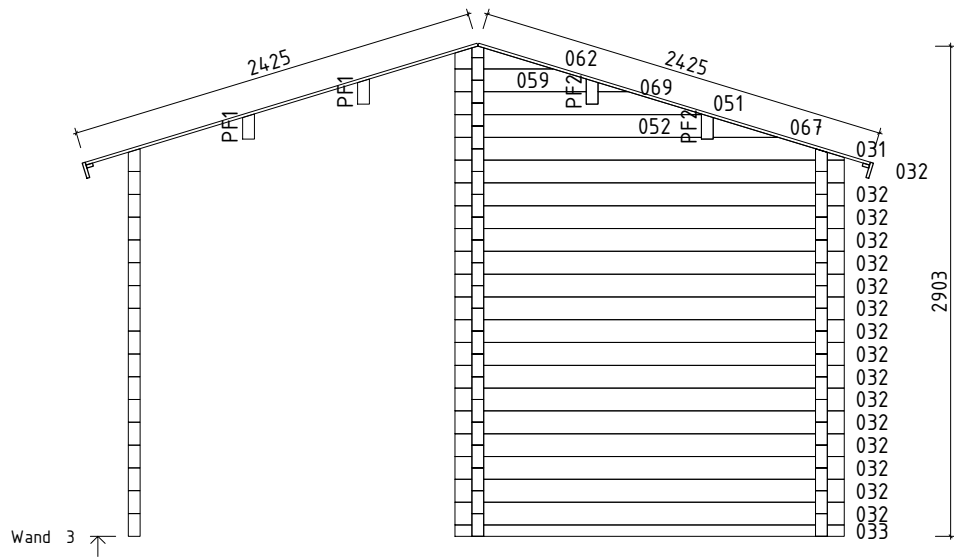

Wandplan 5

570240

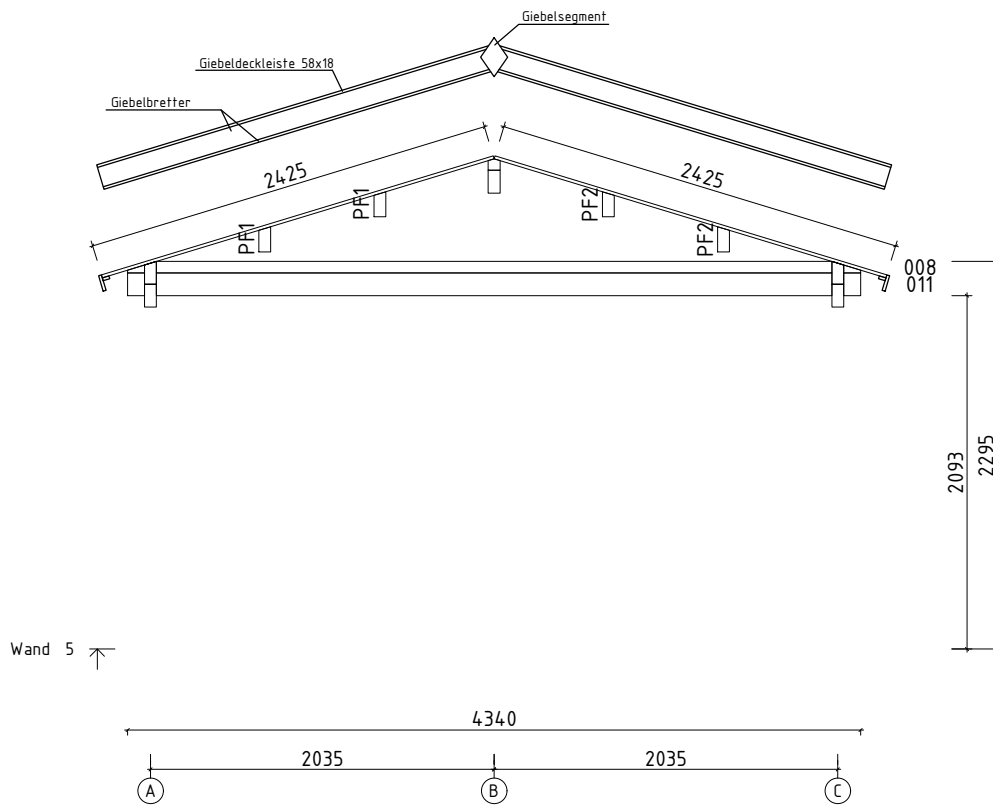

Wandplan A und B

570240

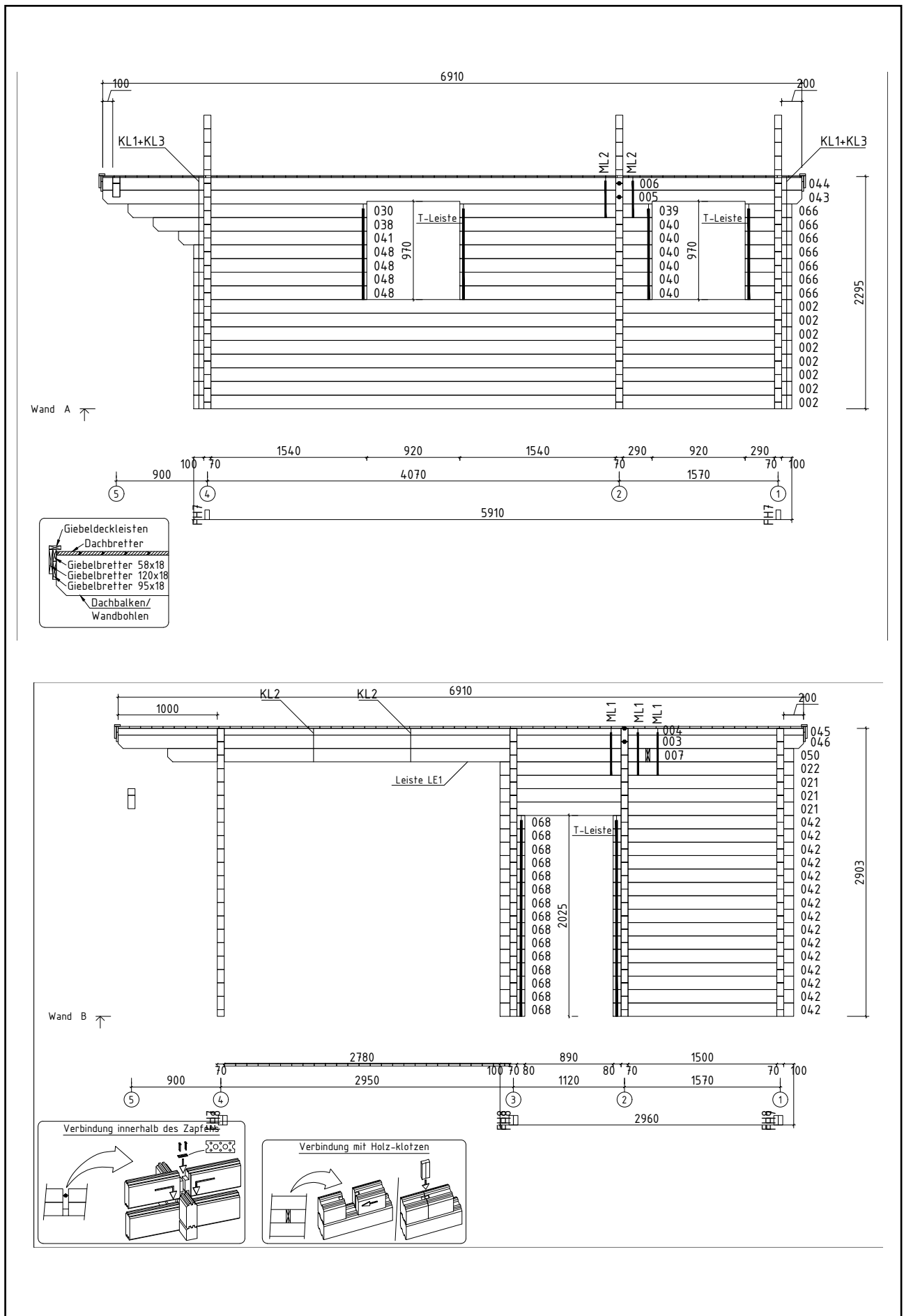

Wandplan C 570240

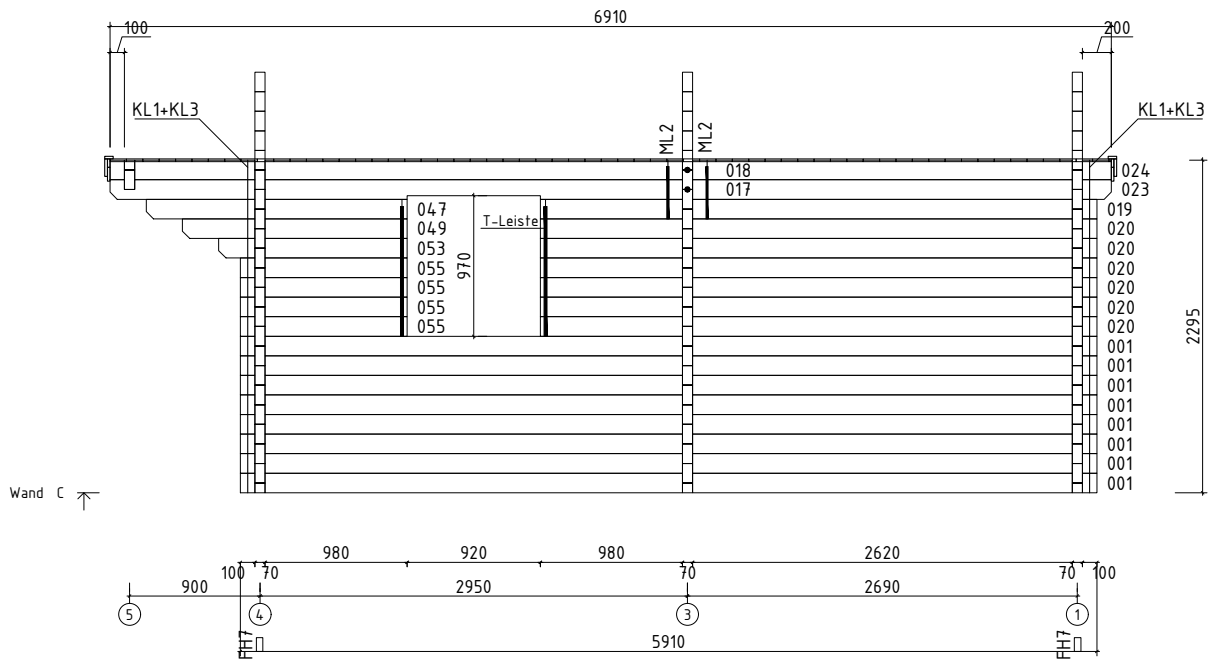

Details 570240

Montageanleitung für T-Leisten / Installing the door and window supports / Tenderliistu paigaldusjuhend.

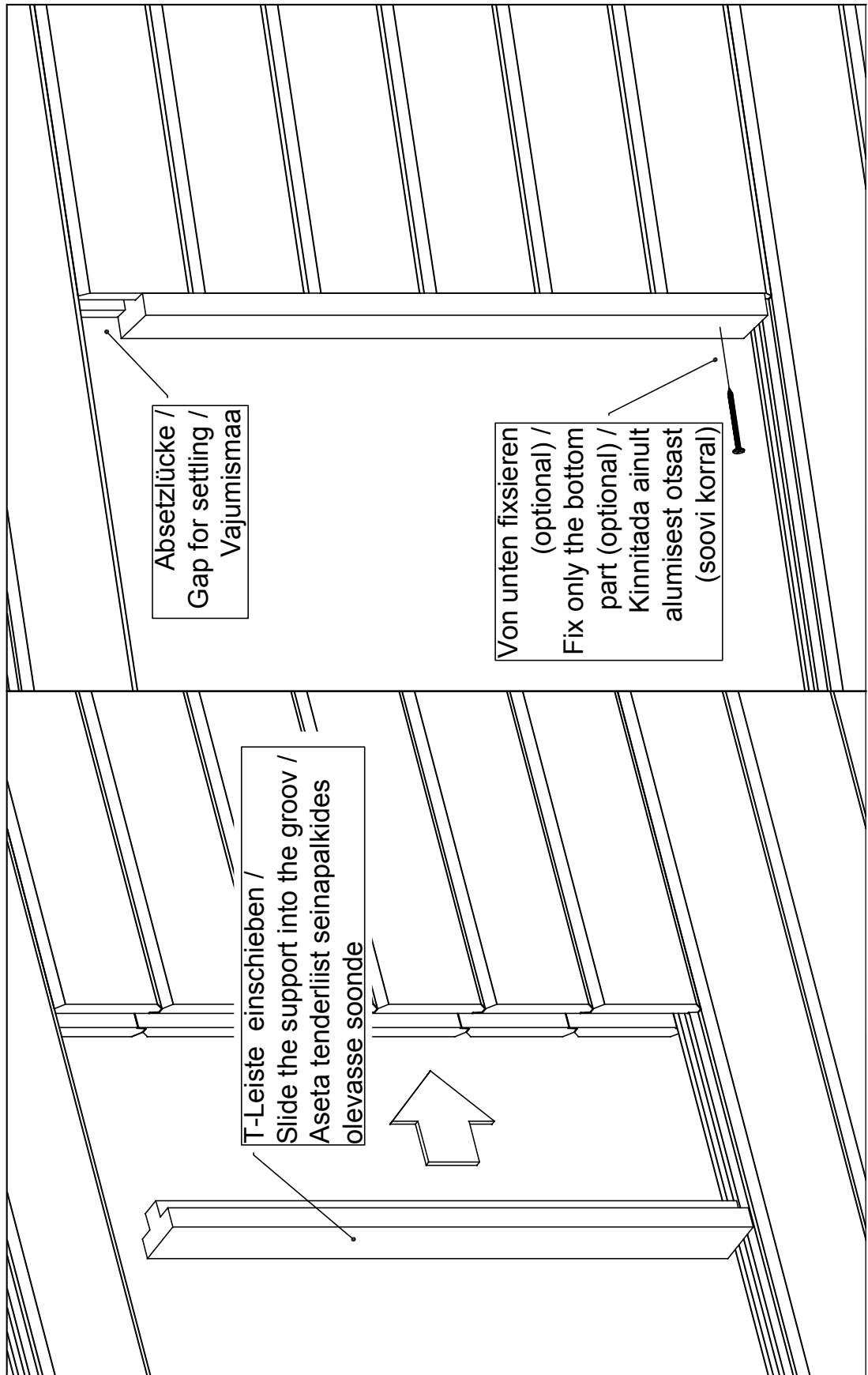

Details

570240

Veeplekk / Window sill / Fensterbank

Q4

1

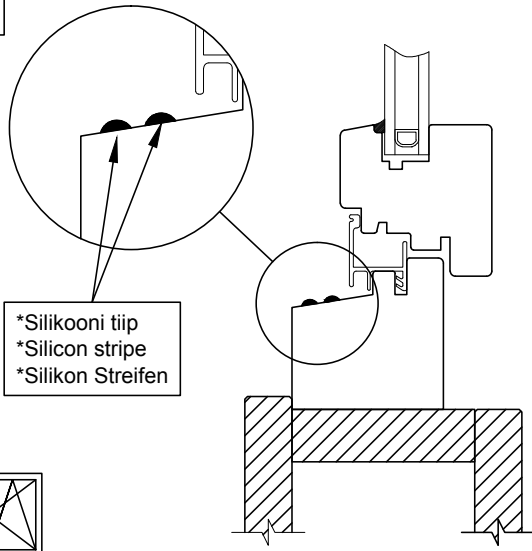

2

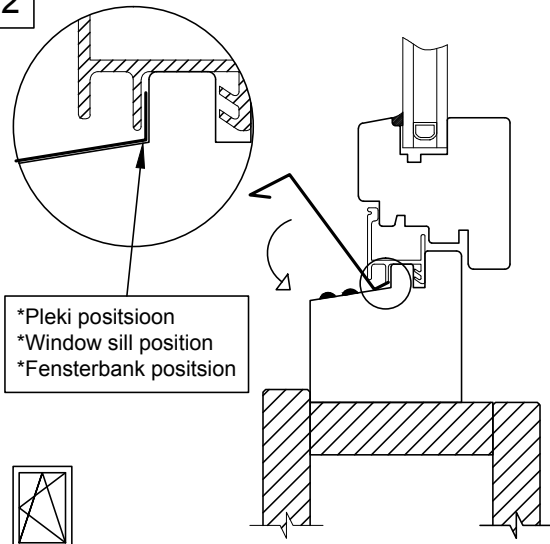

3

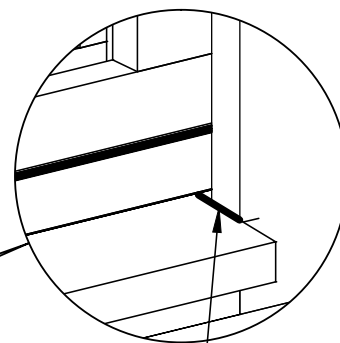
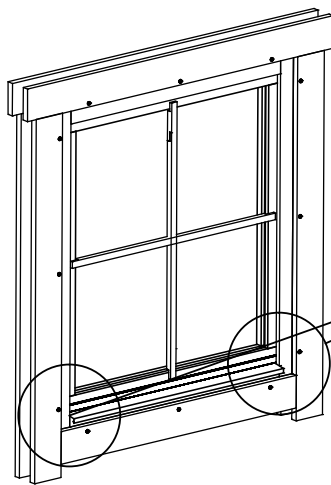

*Silikooni tiip
*Silicon stripe
*Silikon Streifen

1

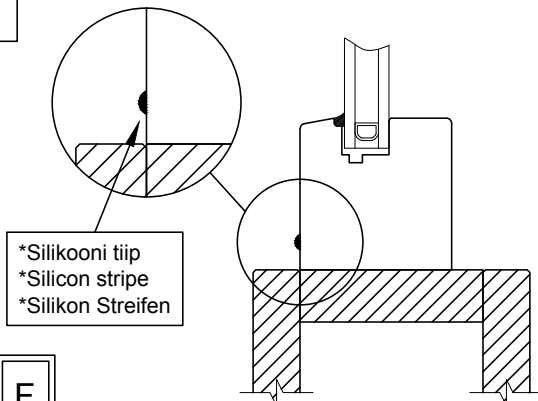

2

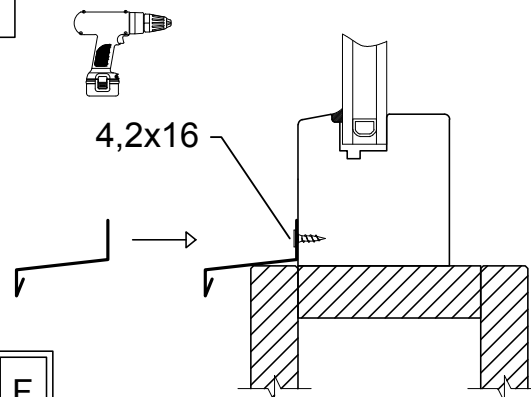

Details

570240

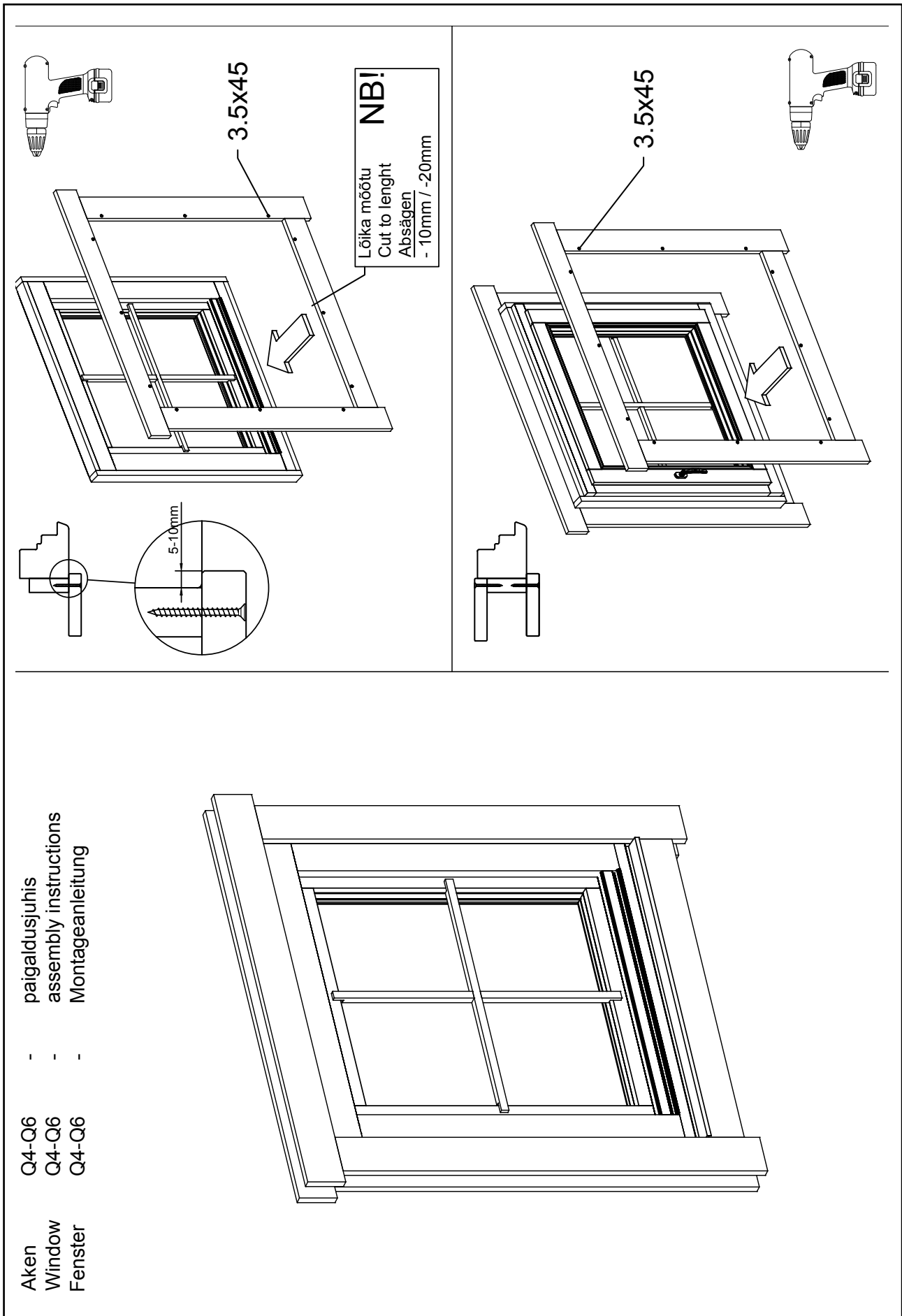

Q4-Q6 - paigaldusjuhhis
 Q4-Q6 - assembly instructions
 Q4-Q6 - Montageanleitung

Aken
 Window
 Fenster

Details

570240

Vihmaliist / Rain strip / Wasserleiste

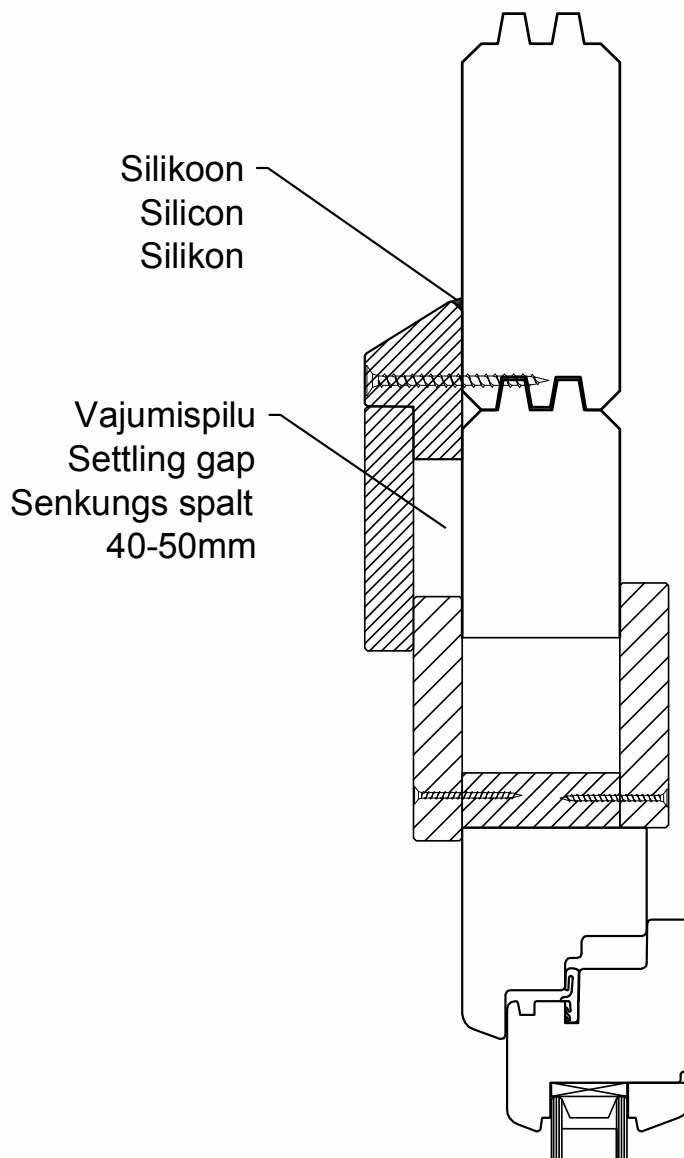

NB!

- Monteerida juhul kui ese on välja toodud maja spetsifikatsioonis!
- Install only if the item is listed in the house specification!
- Nur montieren wenn die Leiste in der Teileliste gezeigt ist!



Details

570240

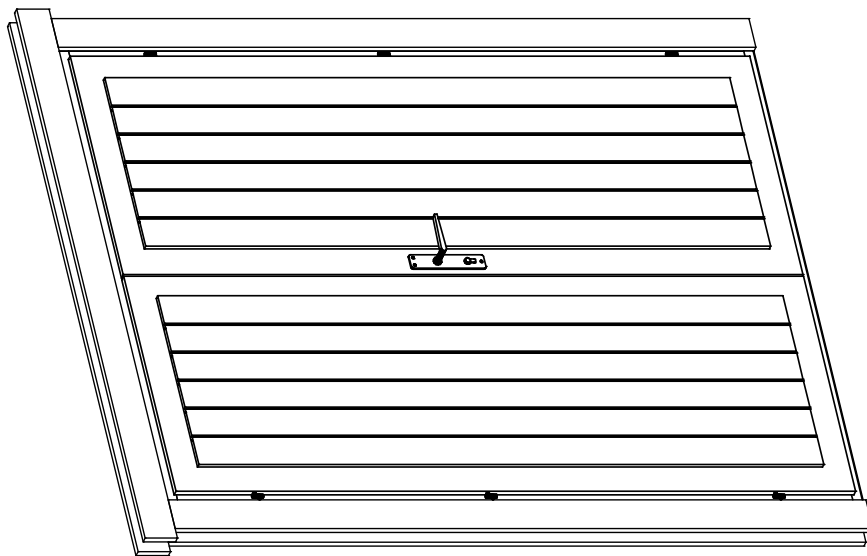
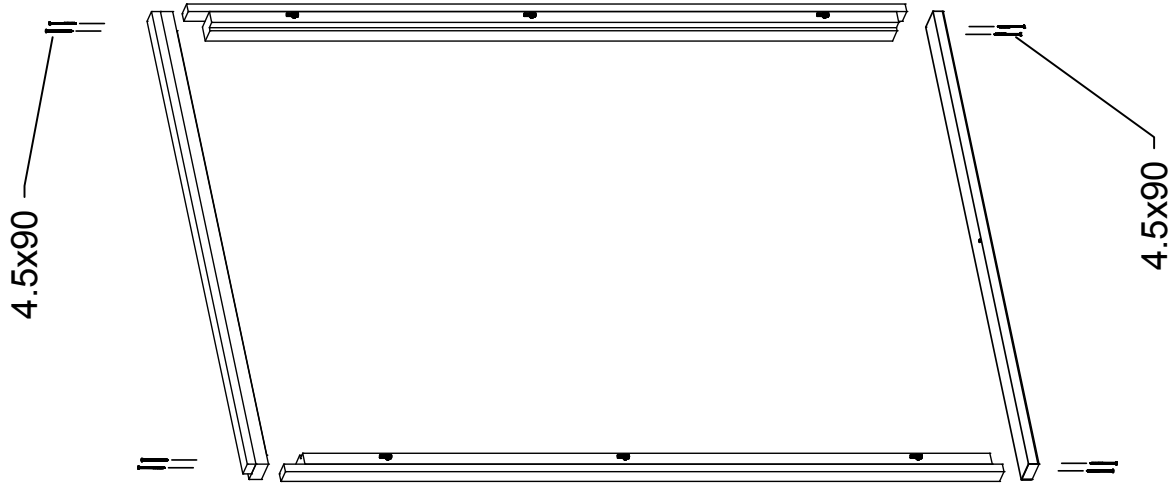

Uksee montaaž / Tür montage / Door assembly
(GH+ / SH)

Details

570240

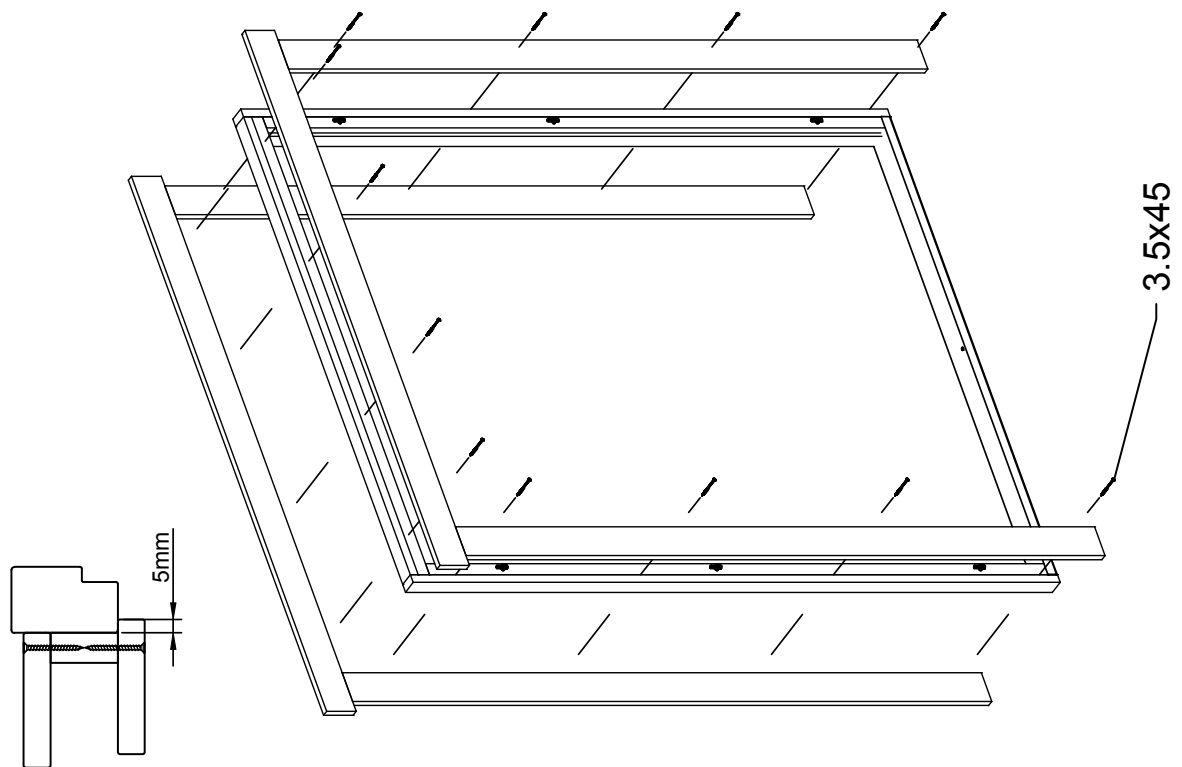
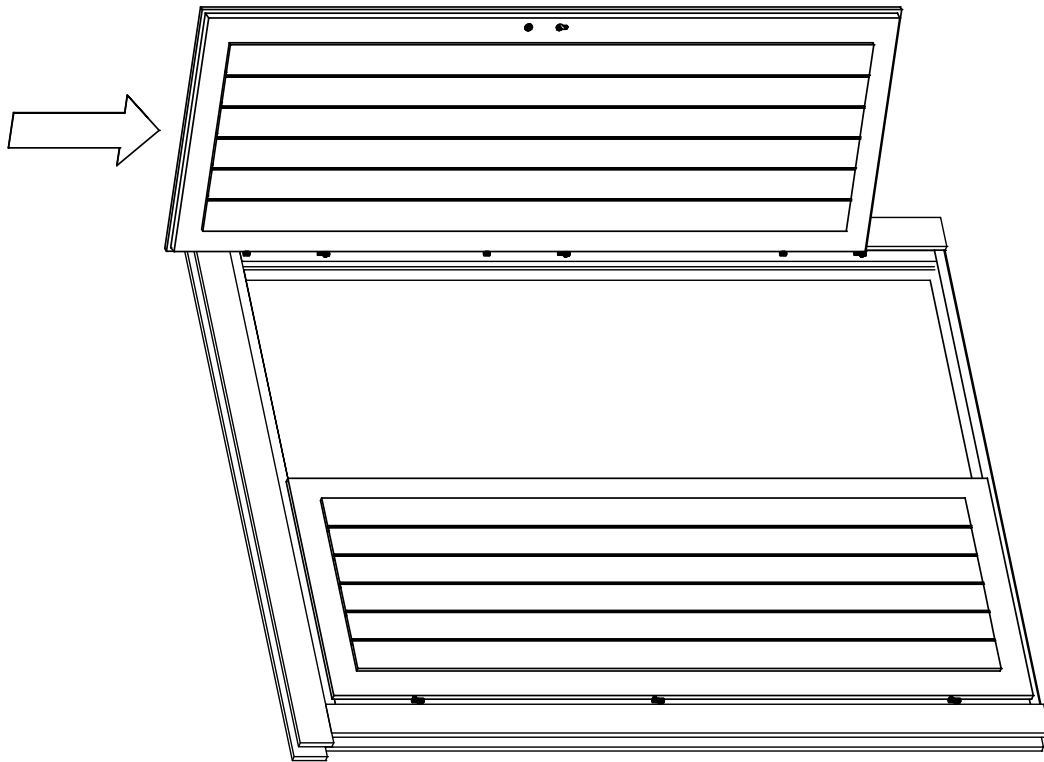

Details

570240

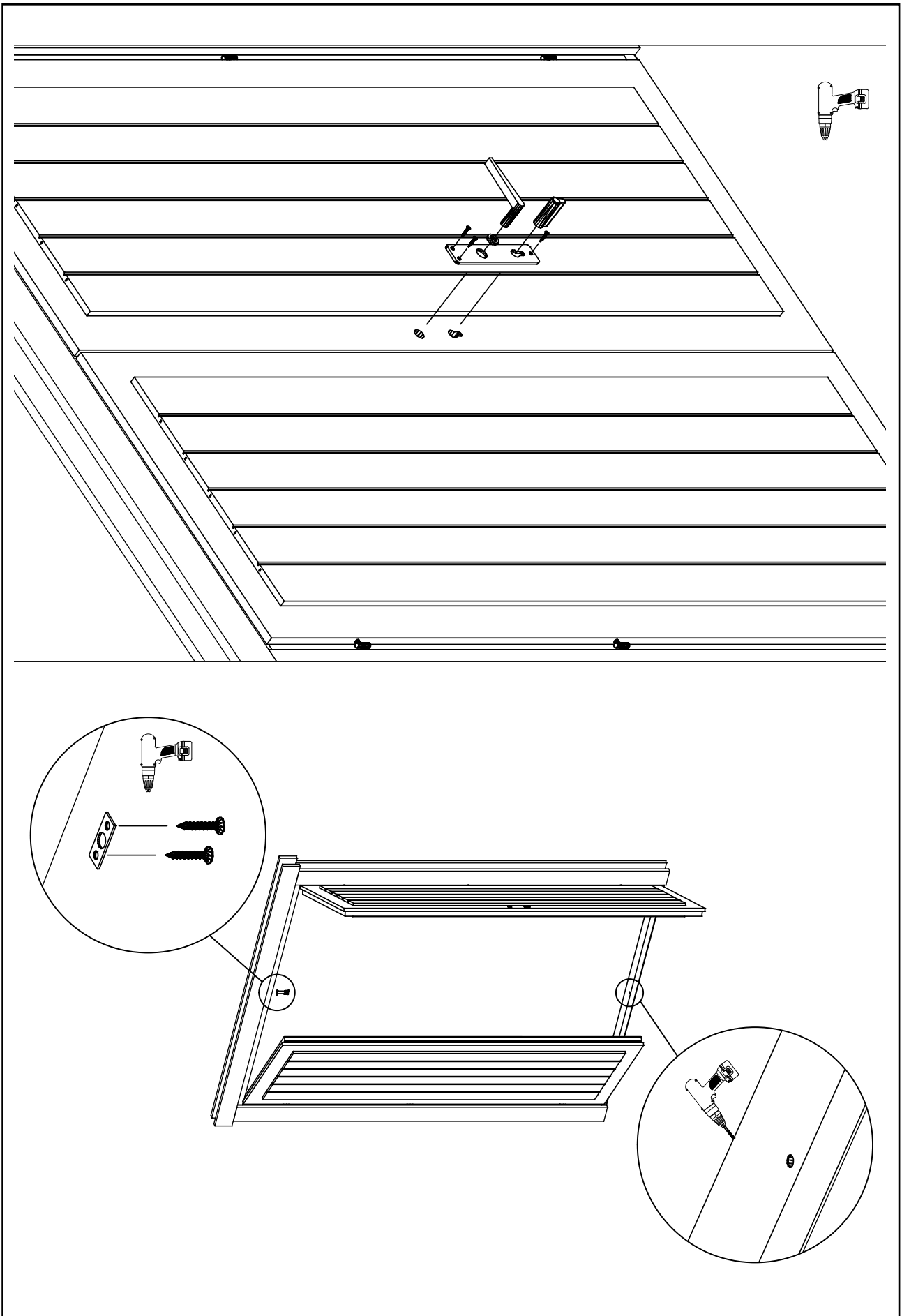

Details

570240

Vihmaliist / Head flashing / Regenschutz

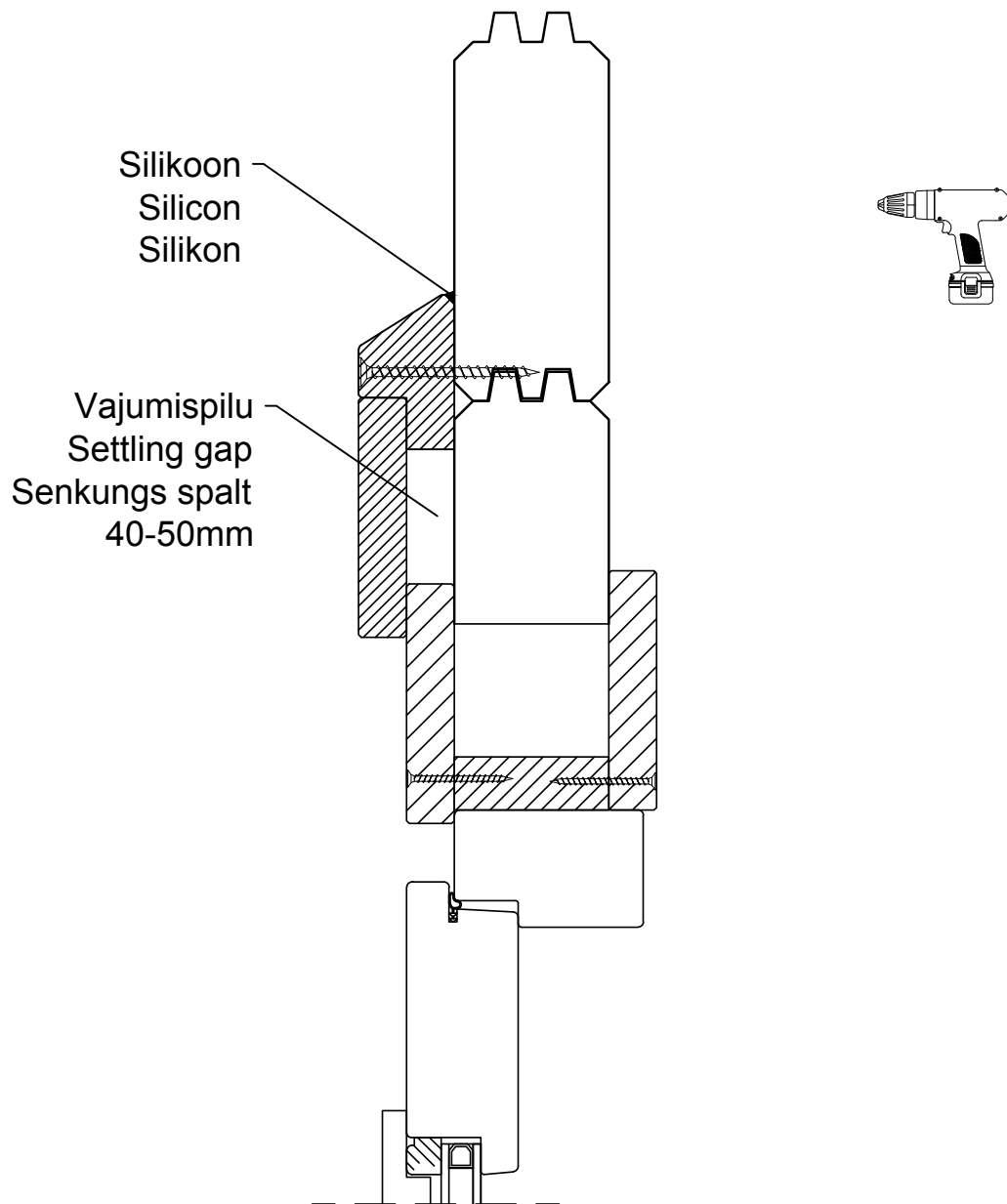

NB!

- Monteerida juhul kui ese on välja toodud maja spetsifikatsioonis!
- Install only if the item is listed in the house specification!
- Nur montieren wenn die Leiste in der Teileliste gezeigt ist!