

Technische Daten: Art.-Nr.: 558380

Wandaußenmaß: 440 x 320 cm

Bohlenstärke: 58 mm



Vom Kunden farblich behandelt.

Kontrolliert durch:

Achtung: Alle angegebenen Maße sind ca.-Maße!

3D-Darstellung und Grundriss 558380

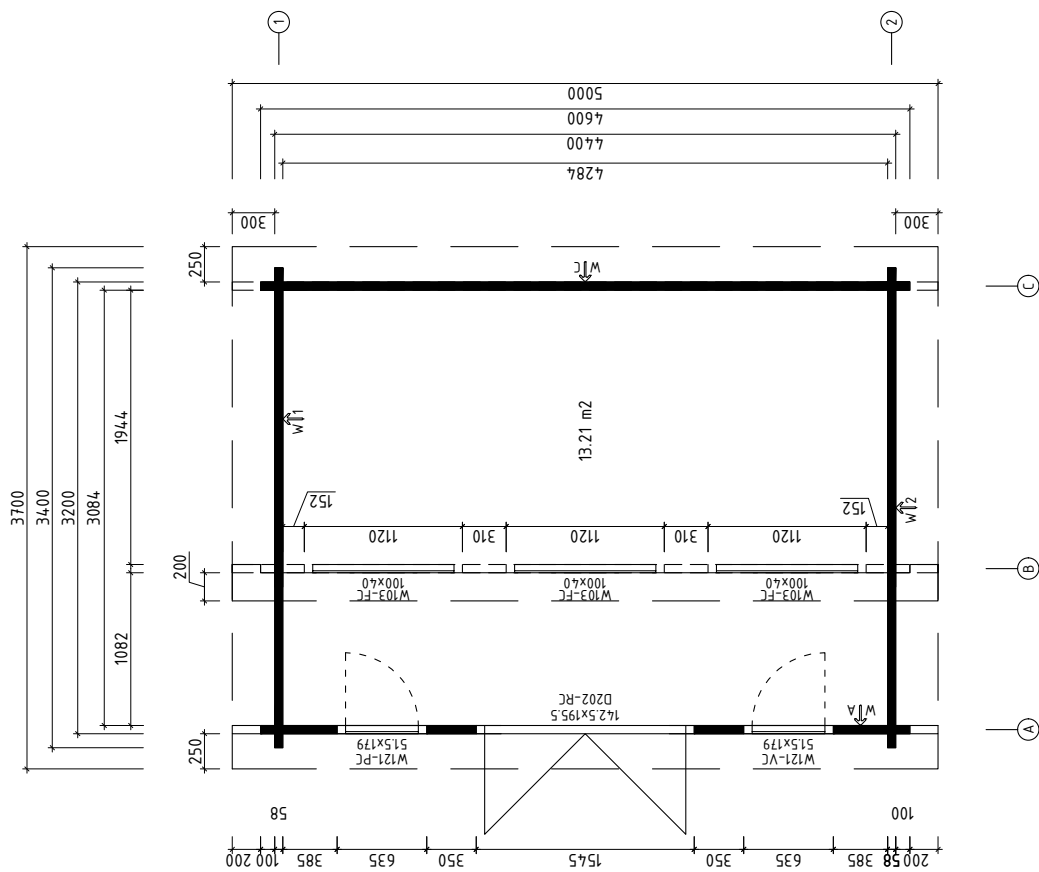
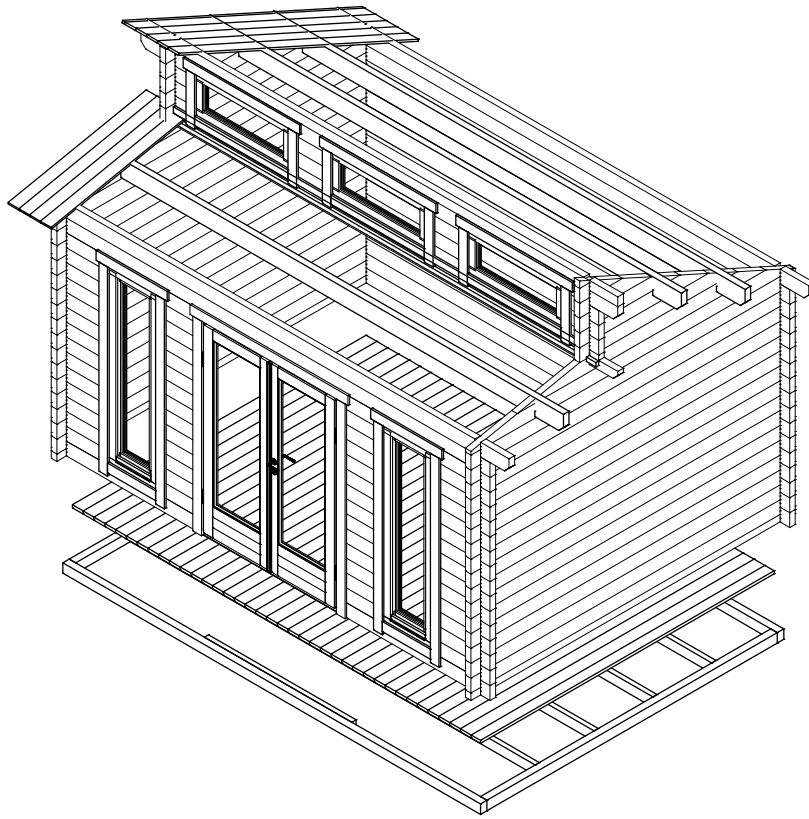





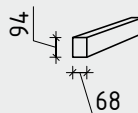
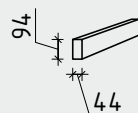
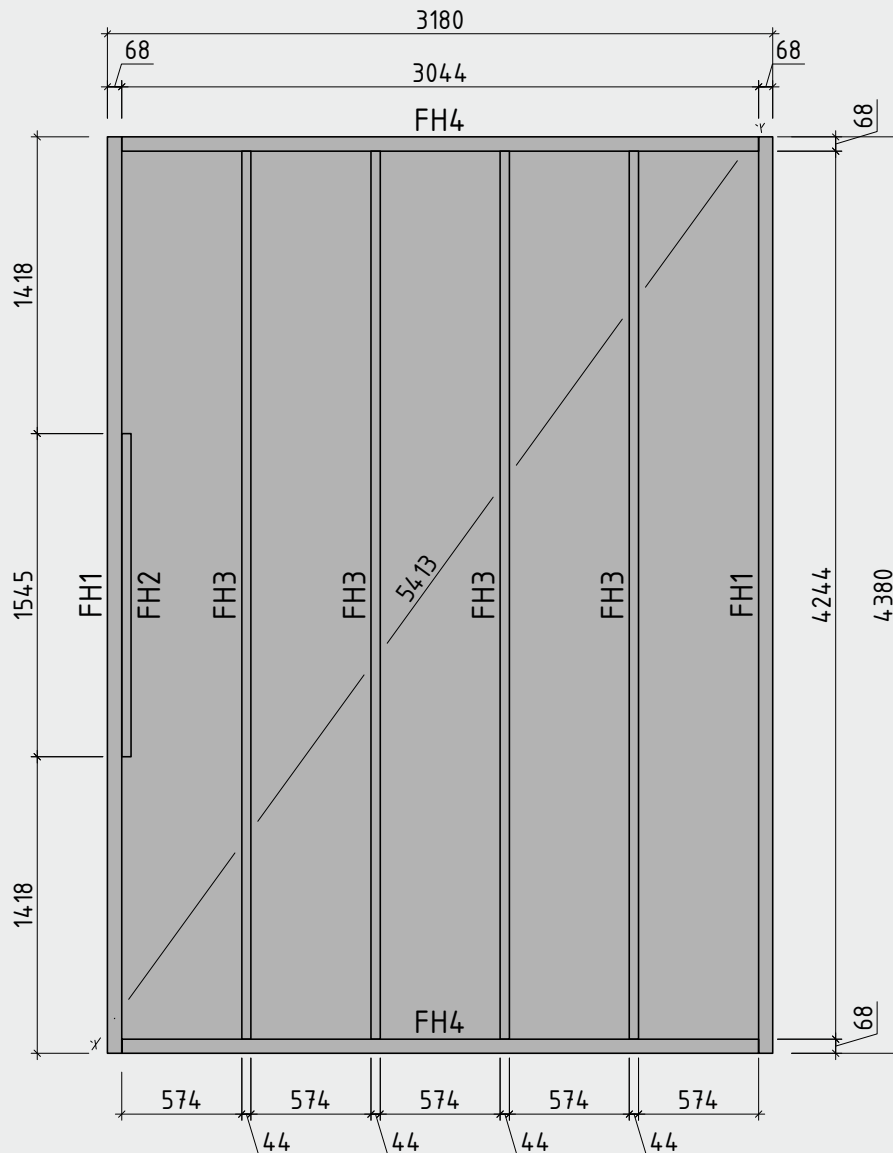





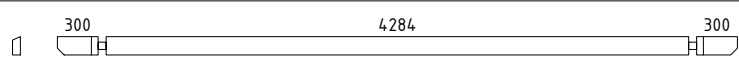
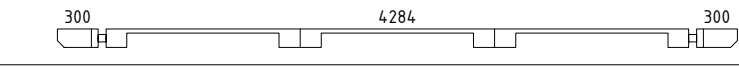
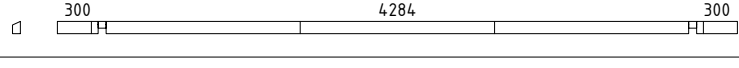
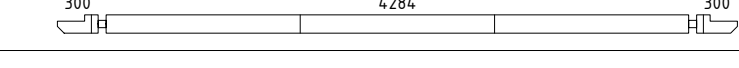
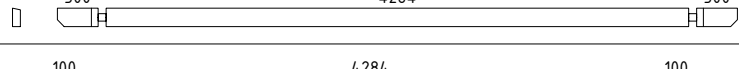
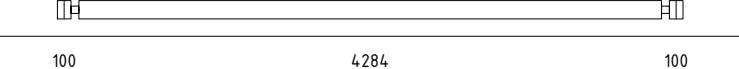
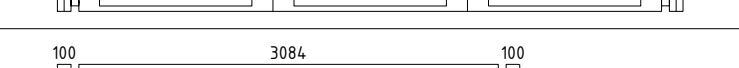
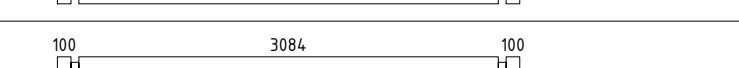
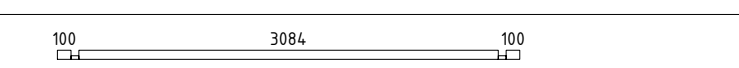
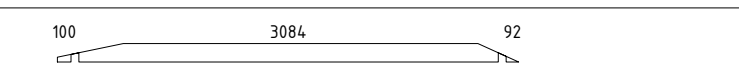
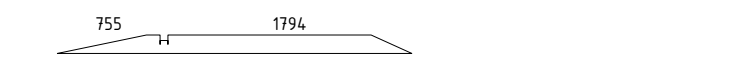

Lagerholzplan und Fundamentplan 558380

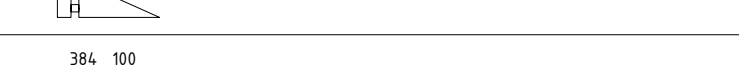
Wir empfehlen als Fundament für Ihr Gartenhaus eine vollflächig, festgegründete gepflasterte oder betonierte Fläche.
Wahlweise ist auch ein Punkt- oder Streifenfundament möglich.

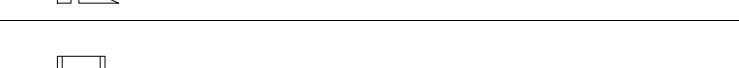



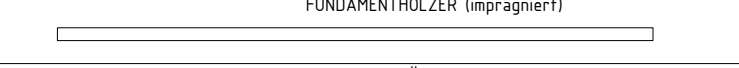
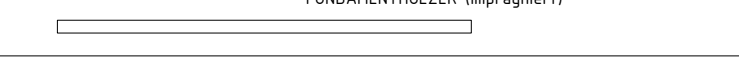
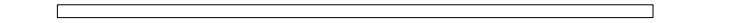







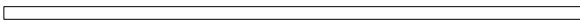
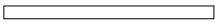

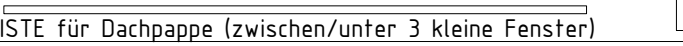
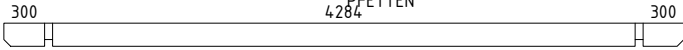
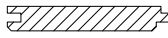

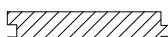





Teileliste 1

558380

Pos		Stck	Profil (mm)	Länge (mm)
001		1	58x135	5000
002		1	58x135	5000
003		1	58x90	5000
004		1	58x135	5000
005		1	58x135	5000
006		17	58x135	4600
007		1	58x135	4600
008		2	58x135	3400
009		30	58x135	3400
010		2	58x68	3400
011		2	58x135	3392
012		2	58x135	2607
013		2	58x135	1652
014		2	58x135	1528
015		2	58x135	1351
016		2	58x135	1051
017		2	58x135	751
018		28	58x135	543
019		2	58x135	450
020		28	58x135	350
021		4	58x135	310
022		4	58x135	310
023		2	58x68	100
FH1	FUNDAMENTHÖLZER (imprägniert) 	2	68x94	4380
FH4	FUNDAMENTHÖLZER (imprägniert) 	2	68x94	3044



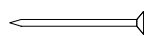



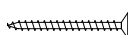
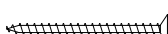
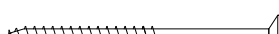
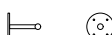

Teileliste 2

558380

Pos		Stck.	Profil (mm)	Länge (mm)
FH3	FUNDAMENTHÖLZER (imprägniert) 	4	44x94	4244
FH2	FUNDAMENTHÖLZER (imprägniert) 	1	44x94	1545
DT1	DECKENTRÄGER 	✓ 2	30x40	2242
LE1	LEISTE LEISTE für Dachpappe (zwischen/unter 3 kleine Fenster) 	✓ 1	18x58	4284
PF1	300 PFETTEN 4284 300 	3	58x170	5000
	DACHBRETTER 	45+1	113x18	2750
	DACHBRETTER 	5	113x18	1480
	DACHBRETTER 	40	113x18	1420
	FUSSBODENBRETTER 	38+1	113x28	3080
	FUSSBODENLEISTE 	✓	14x55	15,0 lfdm
	ABDECKLEISTEN 	✓	15x28	29,0 lfdm
G02-1	GIEBELBRETTER 18x120  11,7° ✓	2	18x120	1560
G02-2	GIEBELBRETTER 18x120  ✓	2	18x120	2830
G06-1	GIEBELDECKLEISTEN 18x58  ✓	2	18x58	1560
G06-2	GIEBELDECKLEISTEN 18x58  ✓	2	18x58	2830
T02-1	TRAUFBRETTER 18x120 	1	18x120	5036
T01-1	TRAUFBRETTER 18x95 	2	18x95	5000
T04-1	TRAUFENDECKLEISTEN 18x40 	2	18x40	2518
T06-1	TRAUFENLEISTEN 18x40  ✓		18x40	15,0 lfdm
TL58-1	T-LEISTE 58 	6	45x58	240
TL58-2	T-LEISTE 58 	4	45x58	1830
TL58-3	T-LEISTE 58 	2	45x58	1975
SH	Schlaghölzer 	3		
NG04	NÄGEL 2.5x50 Dachbretter 	630		
NG05	NÄGEL 2.5x60 Fussbodenbretter 	456		

Teileliste 3

558380

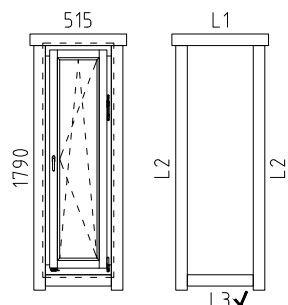
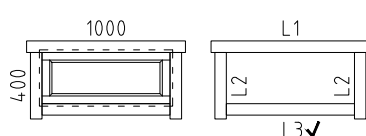
Pos		Stck	Profil (mm)	Länge (mm)
SR32	SCHRAUBEN 3.0x30 Abdeckleisten 28x15, FBLEISTE Traufenleiste 40x18, Traufendeckleiste 40x18		134	
SR37	SCHRAUBEN 3.5x45 Giebelbretter, Traufenbretter LE1, Türstopper, Fenster und Türleisten		214	
SR44	SCHRAUBEN 4.0x60 Deckenträger DT1		20	
SR57	SCHRAUBEN 5.0x100 Fundamenthölzer		36	
TST	Türstopper		1	
KL1	Gewindestange M8		4	2000
KL2	Gewindestange M8		4	765
KL3	Gewindestange M8		4	325
	Mutter M8		8	
	Mutter M8 U-Scheibe Ø25		8	
	U-Scheibe M8 Ø25		8	
	Befestigungsmutter M8		4	
	FENSTER 515x1790		2	
	 <p>1xW121-PC; 1xW121-VC</p> <p>L1 18x90 L=755mm 2x L2 18x90 L=1910mm 4x L3 18x90 L=515mm 2x ✓</p> <p>DIN 1xrechts, 1xlinks</p>			
	FENSTER 1000x400		3	
	 <p>W103-FC</p> <p>L1 18x90 L=1240mm 2x L2 18x90 L=520mm 4x L3 18x90 L=1000mm 2x ✓</p>			

Wandplan 1 558380

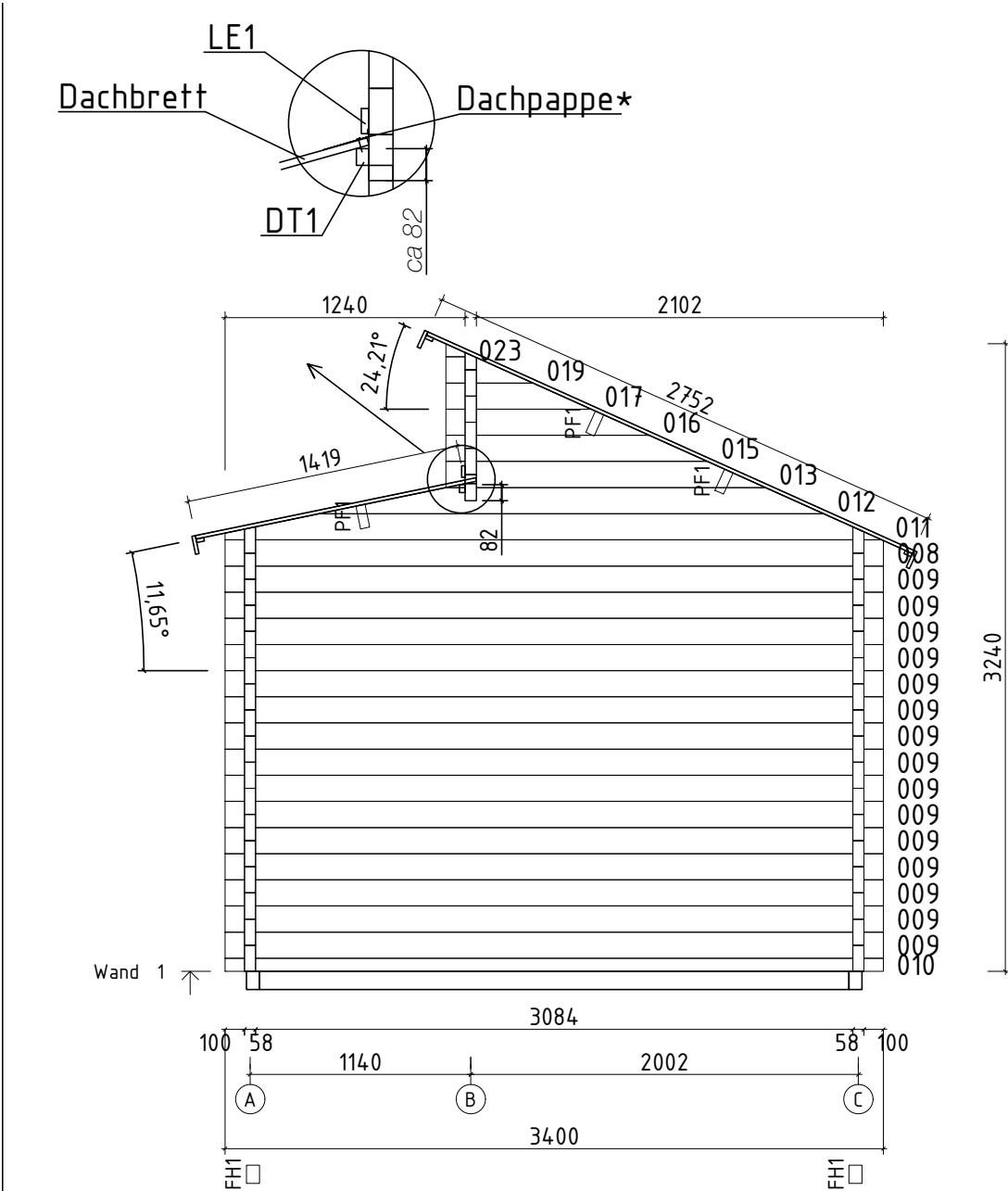

Wandplan 2 558380

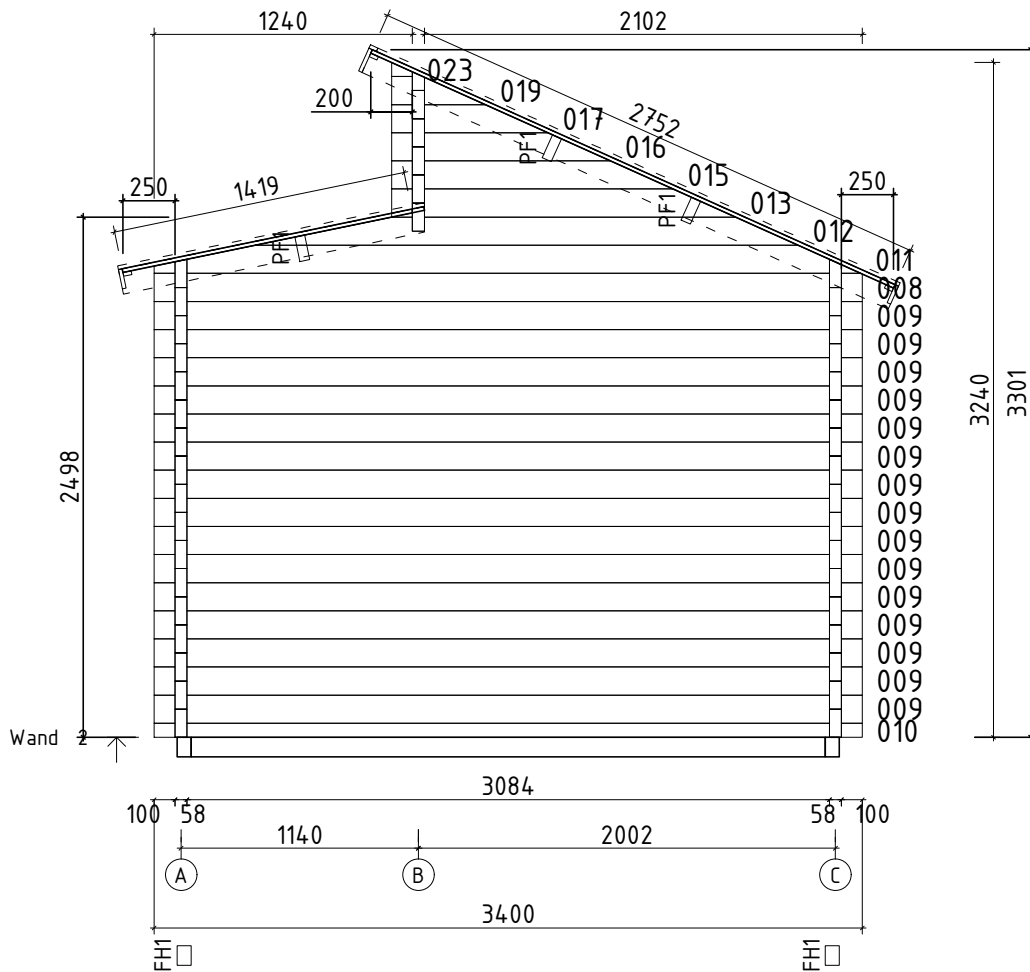
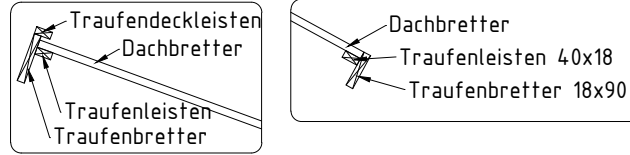

Details 558380

Montageanleitung für T-Leisten / Installing the door and window supports / Tenderliistu paigaldusjuhend.

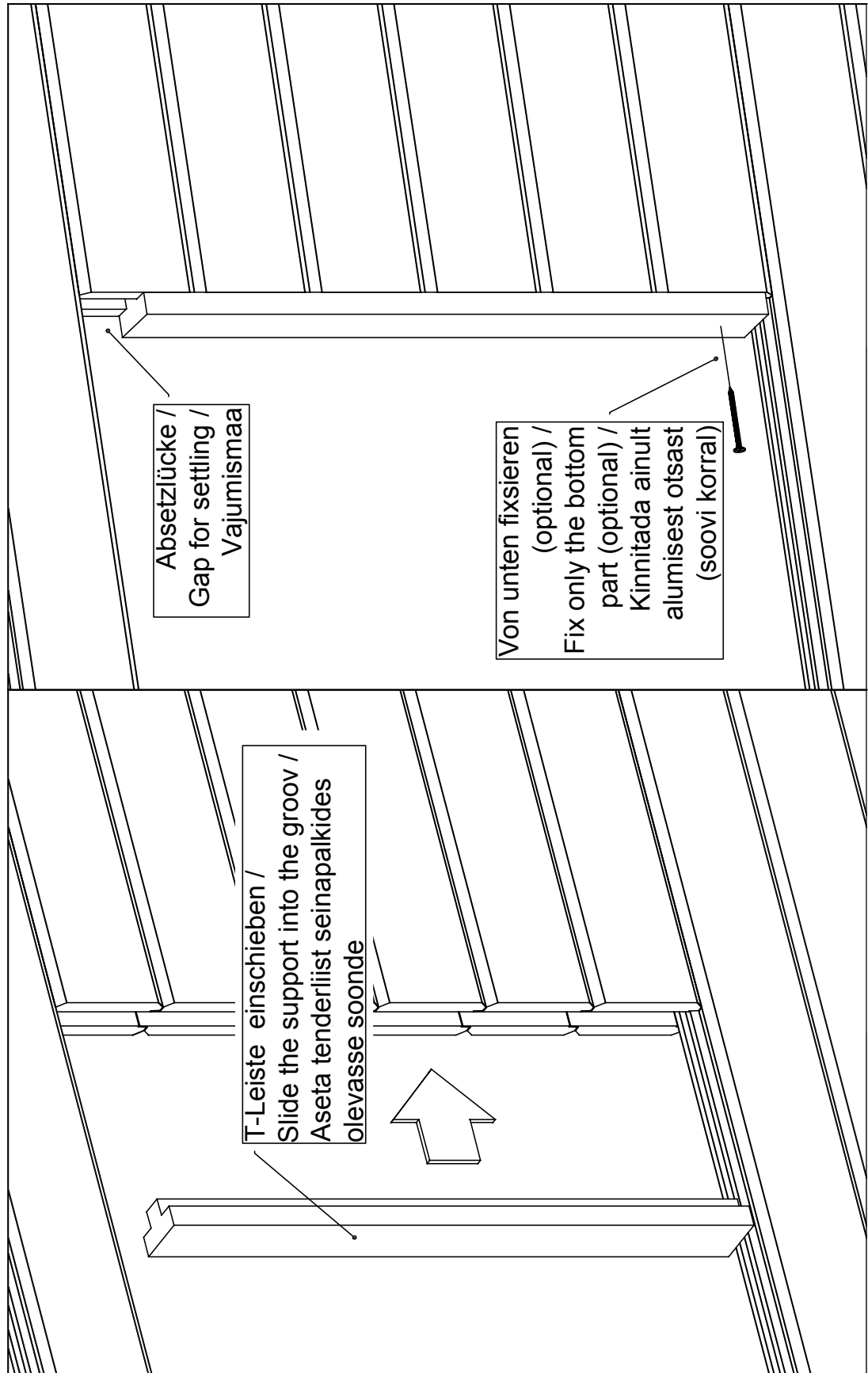

Details 558380

Akna tüüp / Fenster typ / Window type - A68
(GH+ / SH)

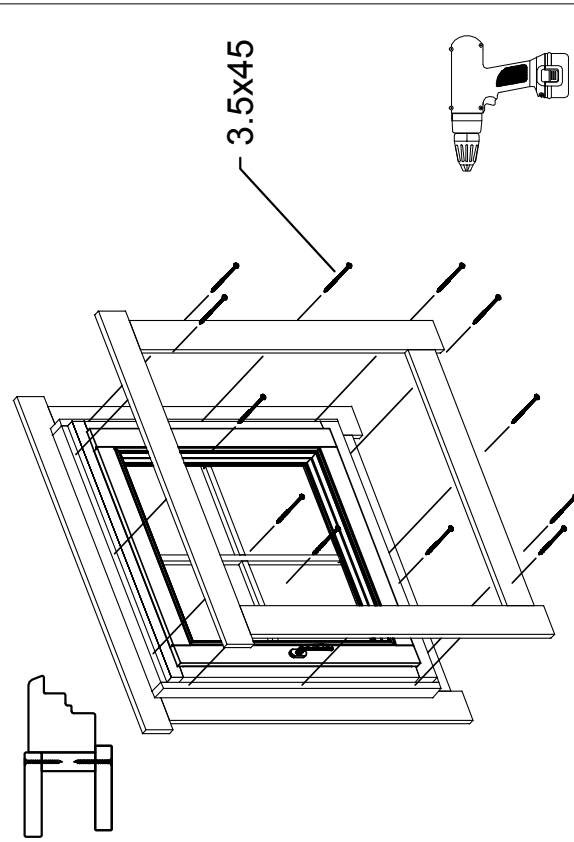
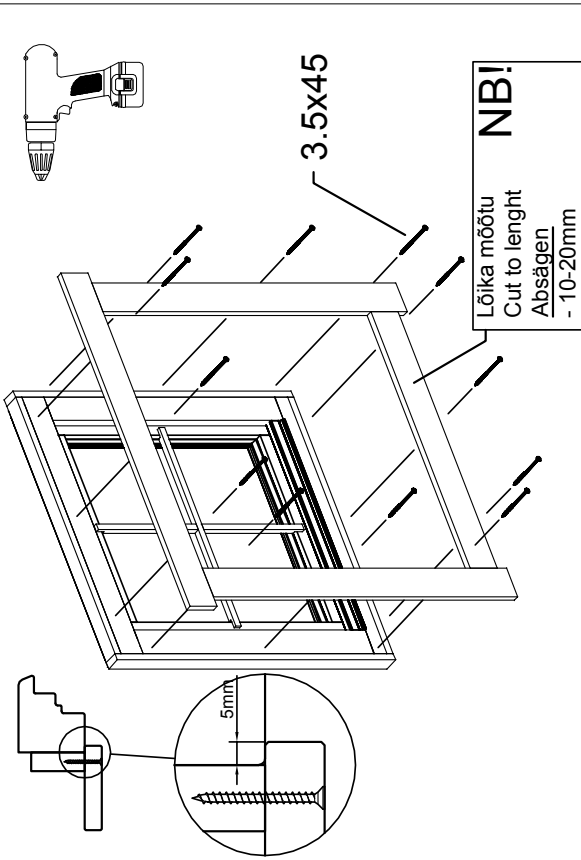
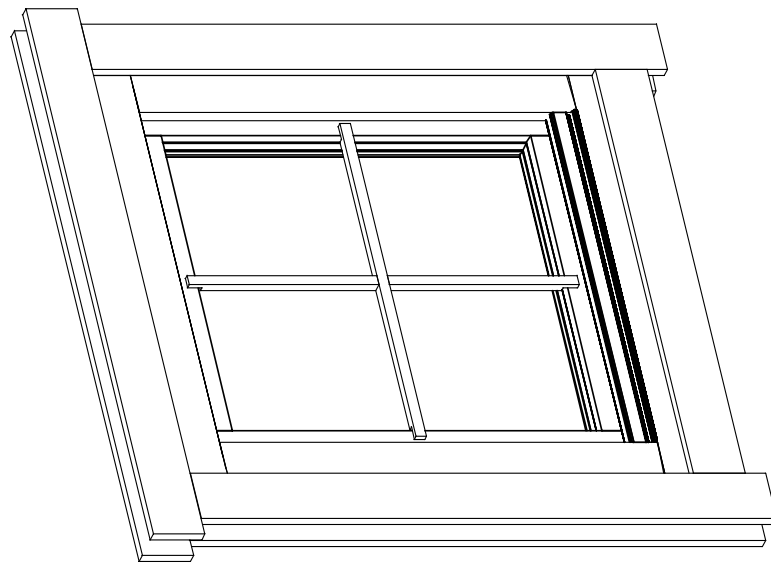

Details 558380

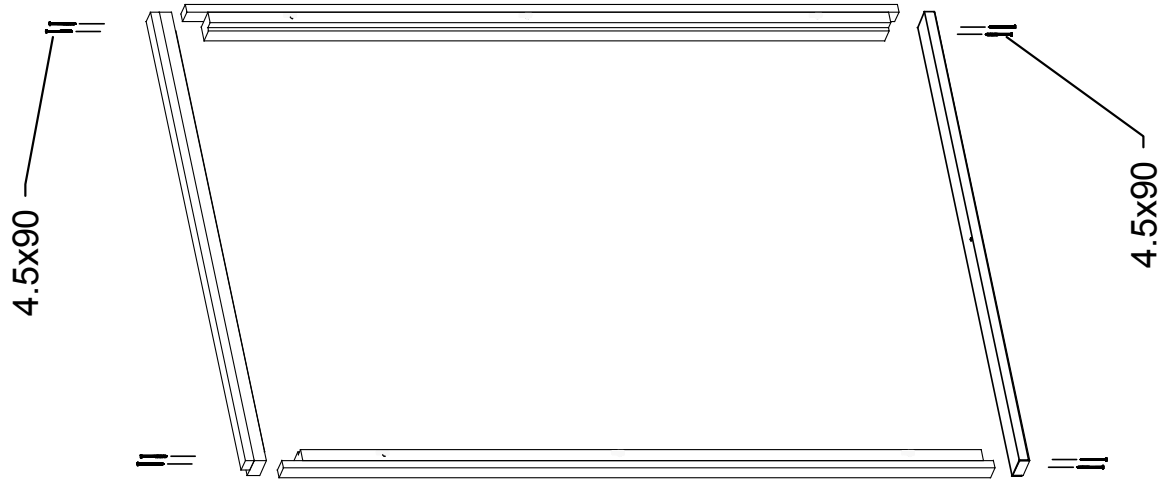

Ukse montaaž / Tür montage / Door assembly
(GH+ / SH)

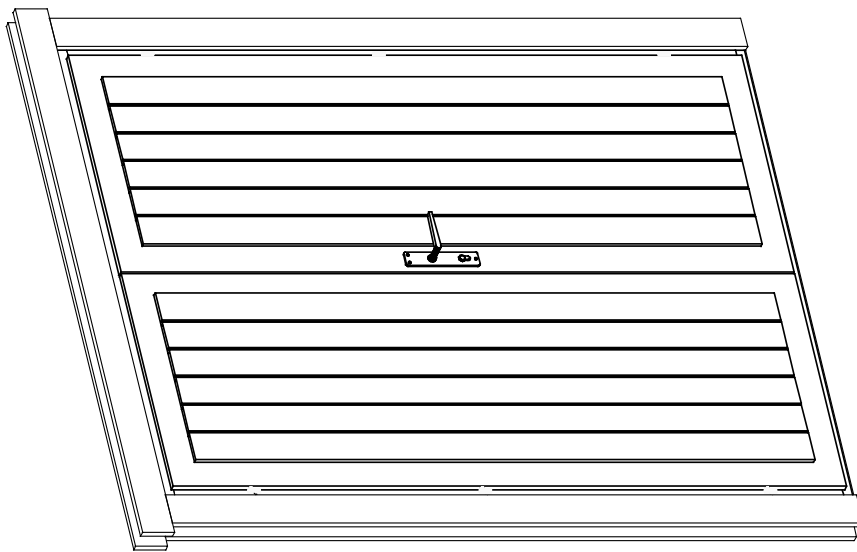

Details 558380

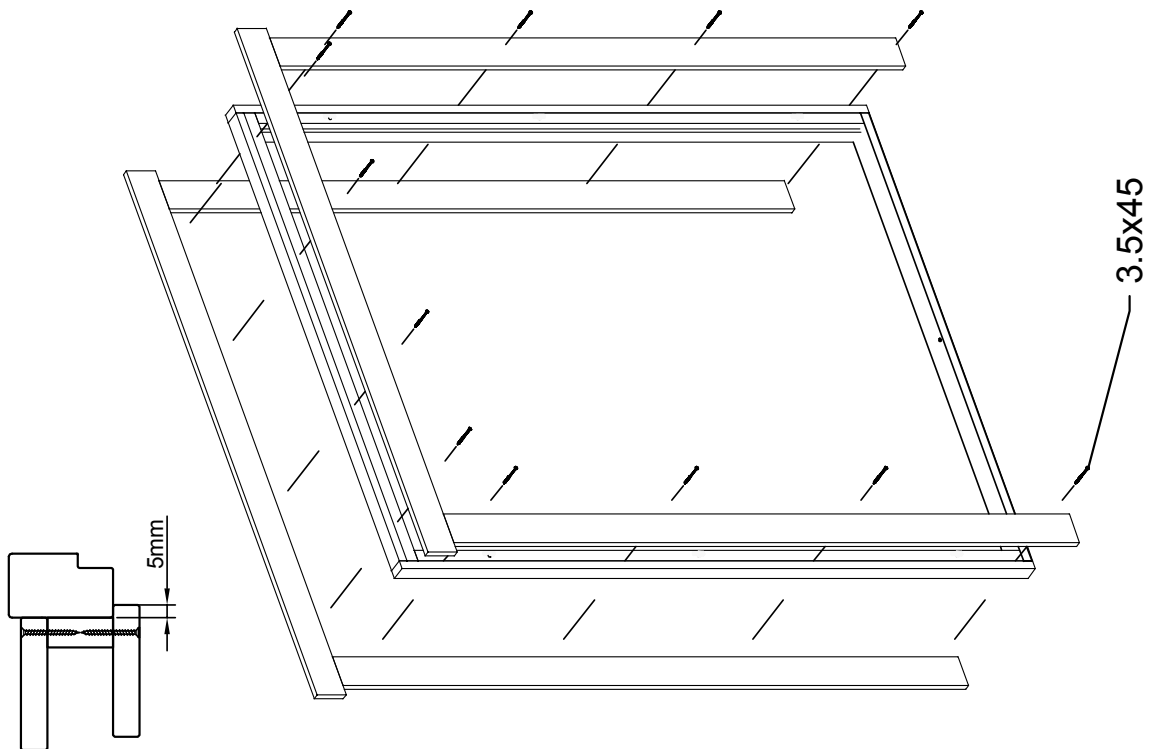
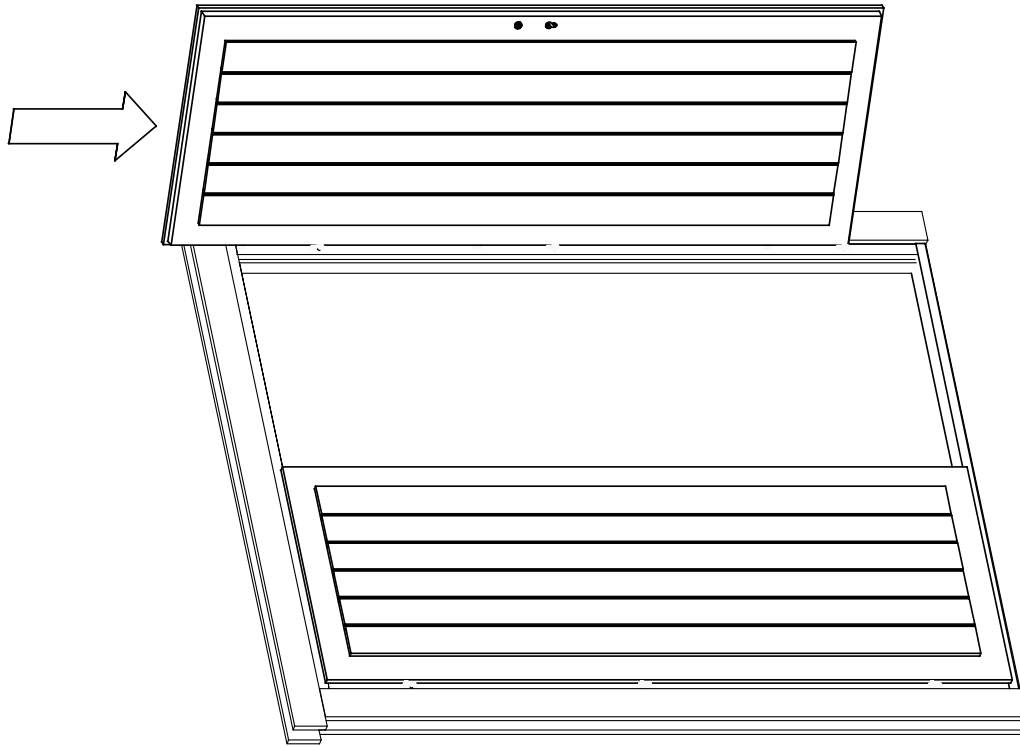

Details 558380

