

Technische Daten: Art.-Nr.: 558205

Wandaußenmaß: 300 x 300 cm

Bohlenstärke: 58 mm



Katrin 44-A. Vom Kunden farblich behandelt.

Kontrolliert durch:

Achtung: Alle angegebenen Maße sind ca.-Maße!

3D-Darstellung und Grundriss 558205

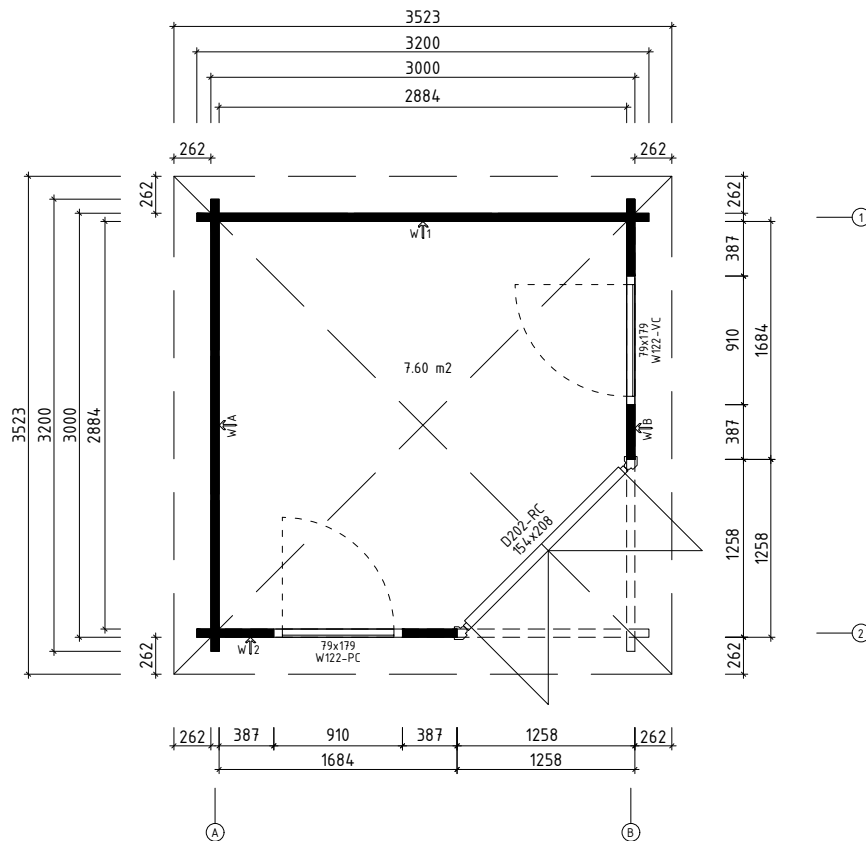
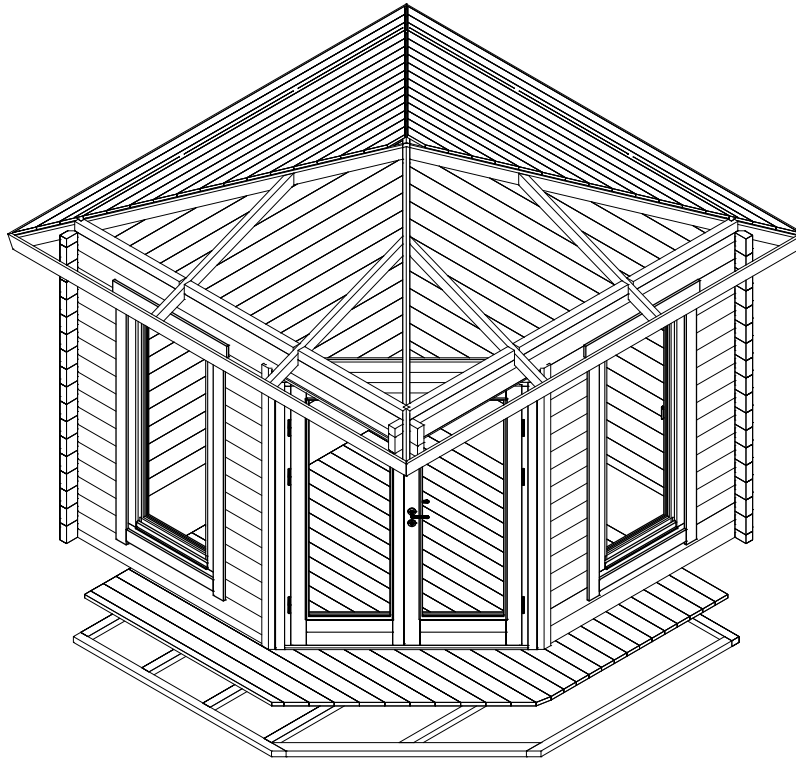

Q4 – Qualitätsklasse für Fenster und Türen
* Fenster und Türen sind ohne Sprossen

Lagerholzplan und Fundamentplan 558205



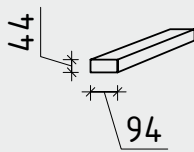
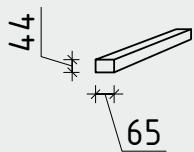
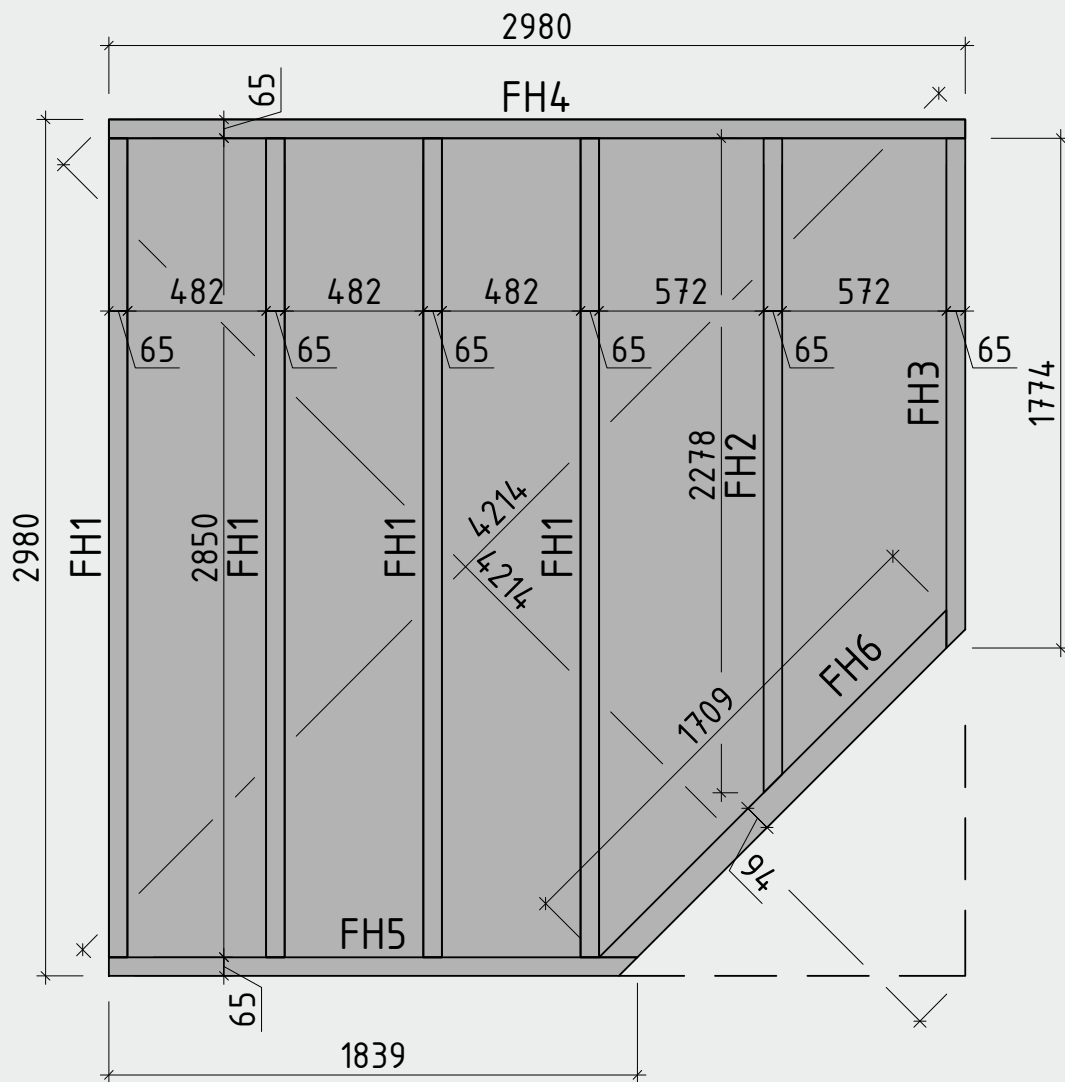



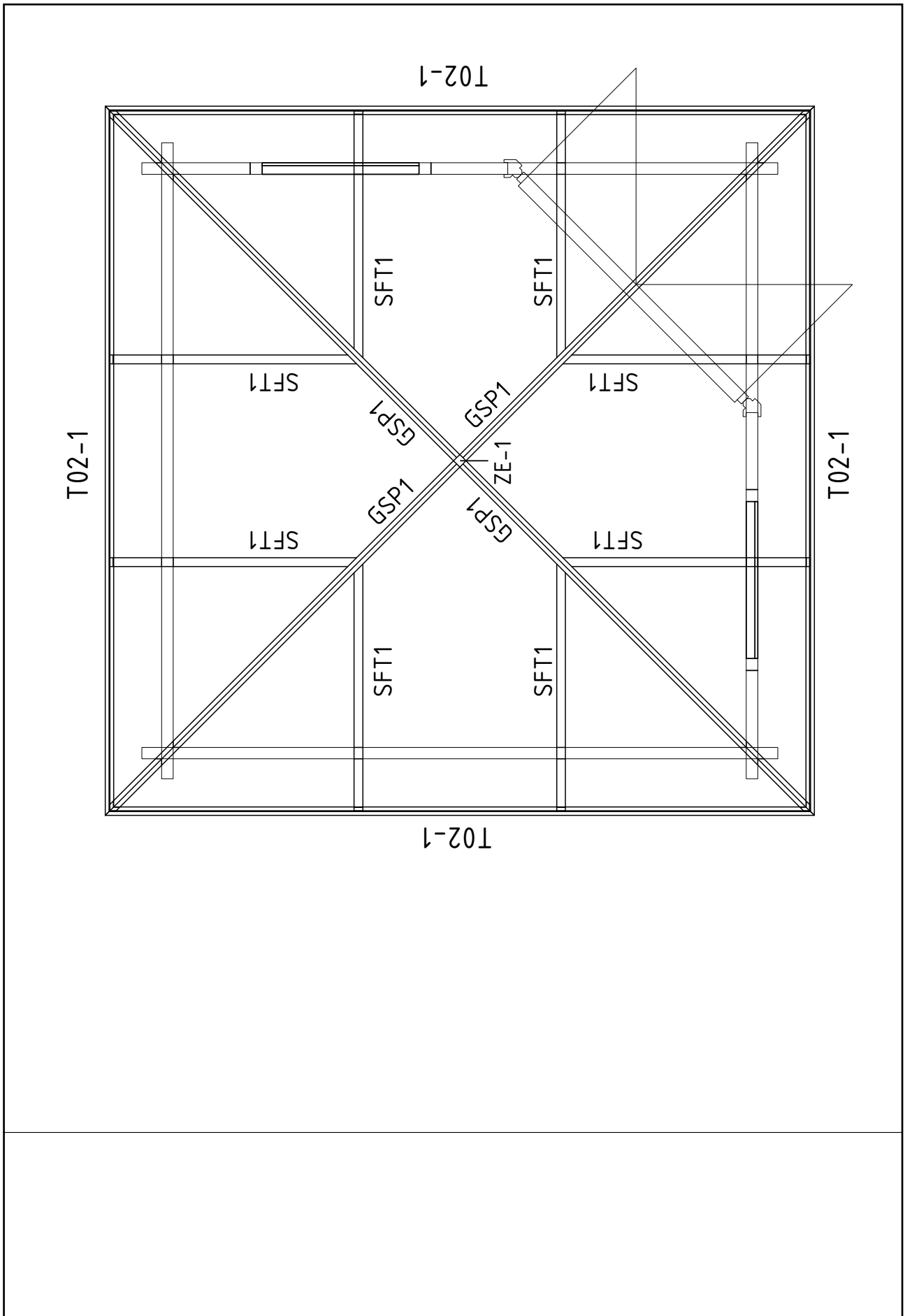

Wir empfehlen als Fundament für Ihr Gartenhaus eine vollflächig festgegründete, gepflasterte oder betonierte Fläche.
Wahlweise ist auch ein Punkt- oder Streifenfundament möglich.

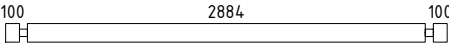
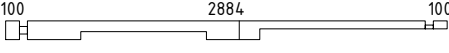
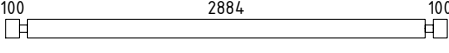
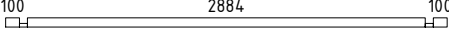
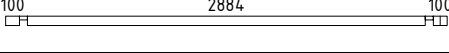
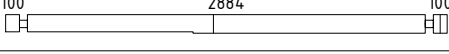
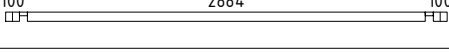
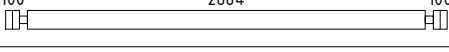
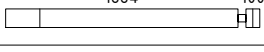
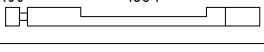
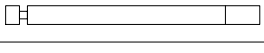
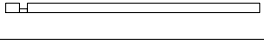
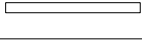
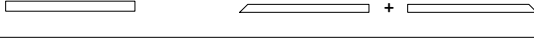

Dachplan 558205



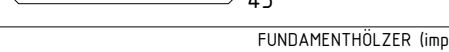
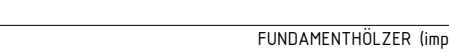

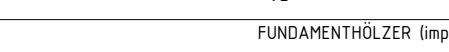
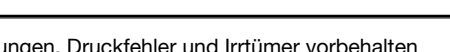







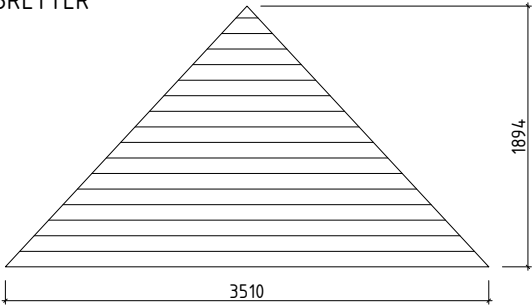
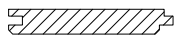
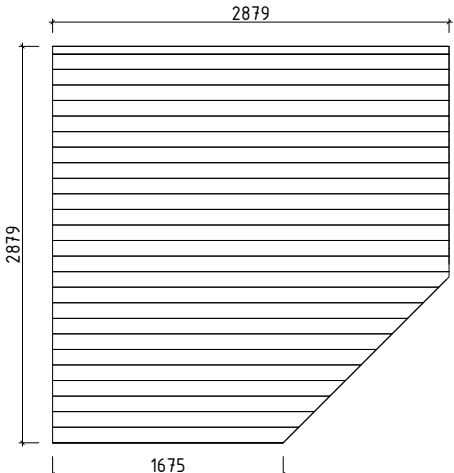

Teilleiste 1 558205

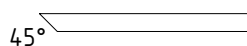
Pos		Stck	Profil (mm)	Länge (mm)
001		2	58x135	3200
002		1	58x135	3200
003		16	58x135	3200
004		1	58x68	3200
005		1	58x68	3200
006		1	58x135	3200
007		1	58x68	3200
008		17	58x135	3200
009		2	58x135	1842
010		1	58x135	1842
011		1	58x135	1842
012		1	58x68	1842
013		4	58x73	976
014		✓ 4+4	58x73	937
015		14	58x135	545
016		13	58x135	545
017		11	58x135	387
018		3	58x135	387
019		13	58x135	387
FH6		1	94x44	1709
FH4		1	65x44	2980
FH1		4	65x44	2850
FH2		1	65x44	2278
FH5		1	65x44	1839
FH3		1	65x44	1774



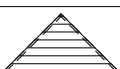

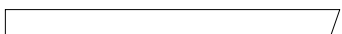



Teileliste 2

558205

Pos		Stck	Profil (mm)	Länge (mm)
GSP1	GRATSPARREN 	4	44x94	2569
SFT1	SCHIFTER 	4+4	44x85	1356
ZE-1	ZENTRALE VERBINDUNGSELEMENT (DACH) 	1	44x44	90
	DACHBRETTER  	4	113x18	
	FUSSBODENBRETTER  	1	113x28	15+1 ohne Ecke 11 mit 45° Ecke
	FUSSBODENLEISTEN  ✓		14x55	11,0 lfdm
DzT 58-1	ECKTÜR- Deckbrett zum Tür 58 	1	18x58	1700
VK2-1	ECKTÜR- Verkleidungsleisten 70 für Vordachelement 45°   ✓	2	70x12	1200
P9L3-1	ECKTÜR- linke Türpfoste 58 	1	90x90	2180
P9R3-1	ECKTÜR- rechte Türpfoste 58 	1	90x90	2180
VE3	ECKTÜR- Vordachelement 1600x825 	1		
TL58-1	T-LEISTE 58 	2	45x58	1695
TL5 8-2	T-LEISTE 58 	2	45x58	1830
T02-1	TRAUFENBRETTER 18x120  ✓	4	18x120	3610

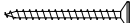
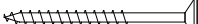
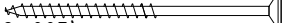
Teileliste 3

558205

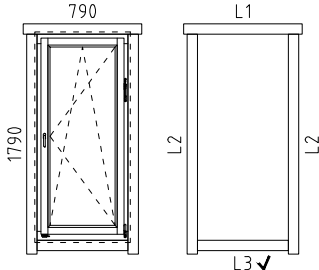
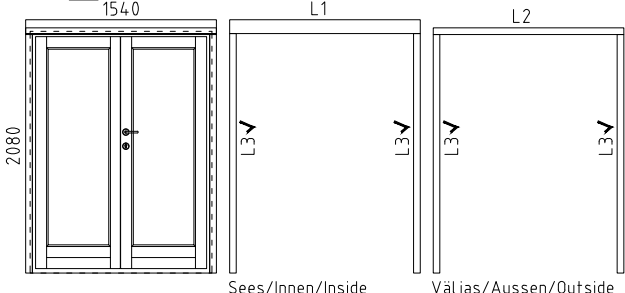
Pos		Stck	Profil (mm)	Länge (mm)
ML1	Metallstange 	4	D10	1170
SH	Schlaghölzer 	3		
NG04	NÄGEL 2.5x50 Dachbretter 	512		
NG05	NÄGEL 2.5x60 Fussbodenbretter 	312		
SR32	SCHRAUBEN 3.0x30 Fussbodenleiste 	25		
SR37	SCHRAUBEN 3.5x45 Traufenbretter, Deckbrett Verkleidungsleiste, Vordachelement Tür- und Fensterleisten 	126		
SR55	SCHRAUBEN 5.0x70 GSP1, SFT1 pos 009 und 012 (1. Bohlenreihe neben die Tür) 	16		
SR57	SCHRAUBEN 5.0x100 Fundamenthölzer Wandbalken (Pos 013, 014, 002, 005) GSP1, SFT1 	78		
KL1	Gewindestange M8 	3		2000
KL2	Gewindestange M8 	3		393
	Mutter M8 U-Scheibe Ø25 	6		
	Befestigungsmutter M8 	3		
	FENSTER Q4  W4-S58P-0XC-07901790 W4-S58V-0XC-07901790 A58-11 / W122-PC + W122-VC L1 18x90 L=1030mm 2x L2 18x90 L=1910mm 4x L3 18x90 L=790mm 2x ✓ DIN 1xrechts; 1xlinks	2		
	TÜR Q4  D4-D58R-0XC-15402080 TU4-SH (196) / D202-RC L1 18x120 L=1656mm 1x L2 18x58 L=1656mm 1x L3 18x58 L=2080mm 4x ✓ DIN rechts Sees/Innen/Inside Väljas/Aussen/Outside	1		
	✓ - bitte selber anpassen (falls nötig!)			

Wandplan 1 und 2 558205

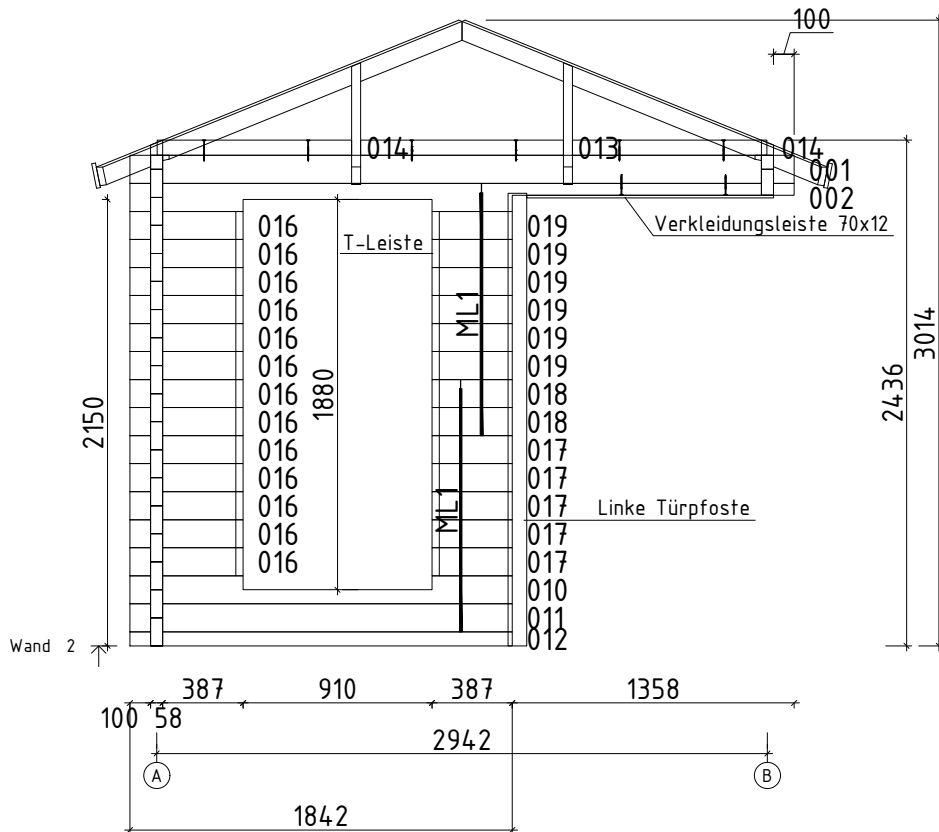
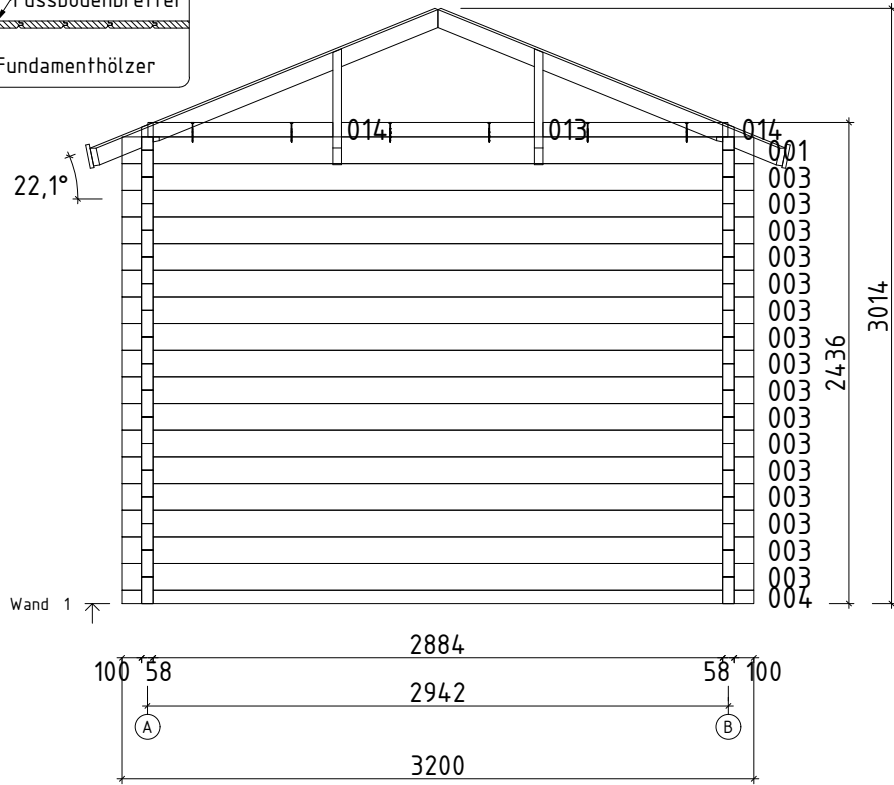
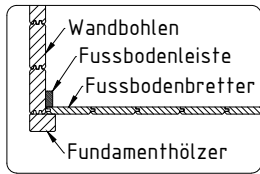

Wandplan A und B 558205

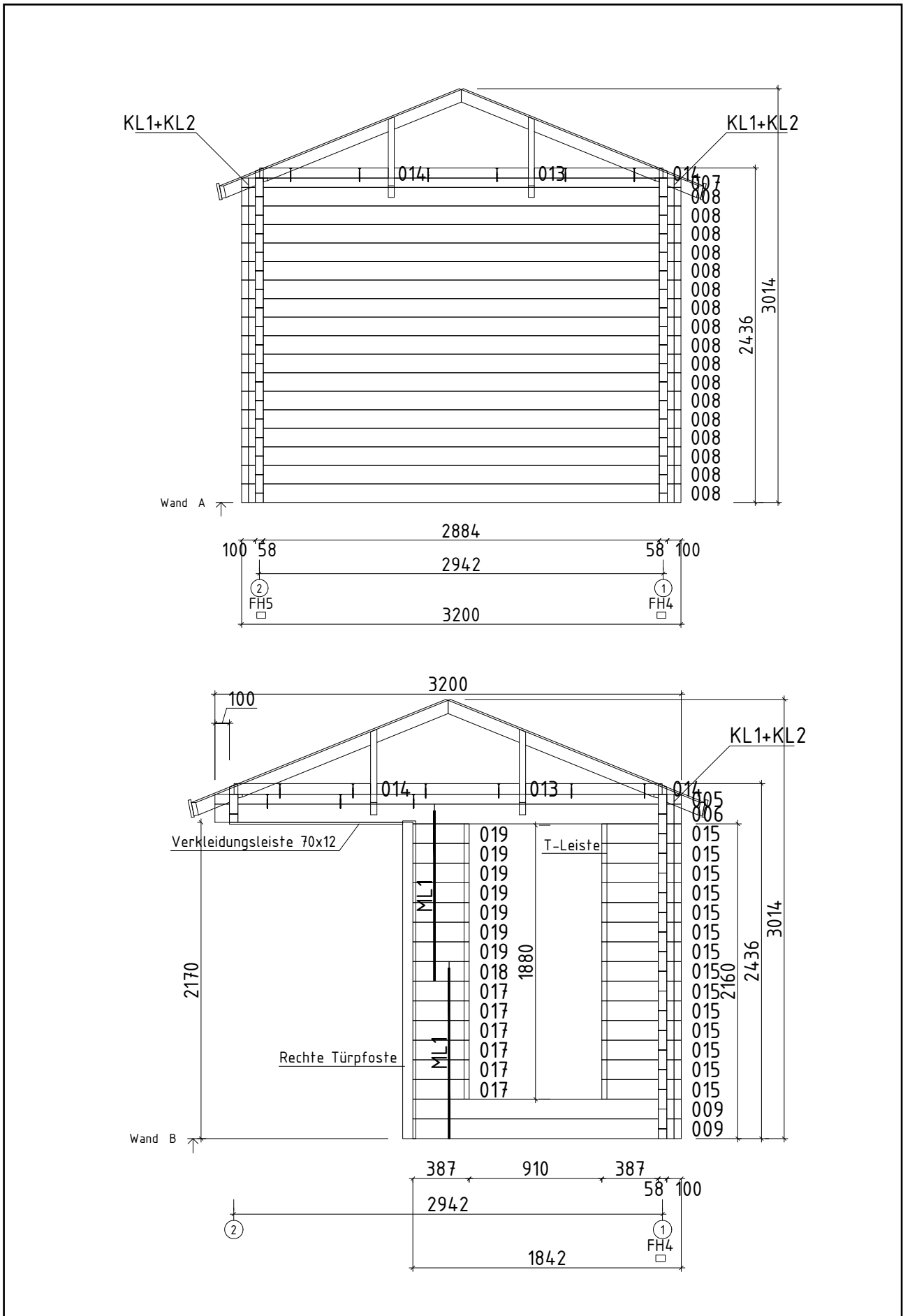

Vordachelement 558205

Step 1: Dachelement an den Wänden verschrauben.
Step 1: Screw canopy element to the wall.

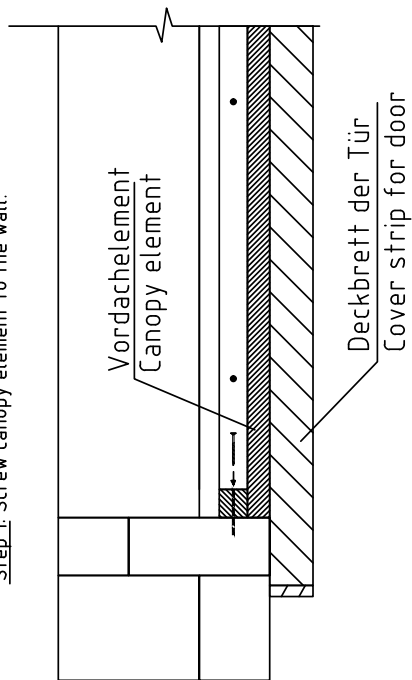

Step 2: Das Deckbrett muss von oben (durch das VD-Element) an das Dachelement verschraubt werden.
Step 2: Fasten cover strip to the canopy element.

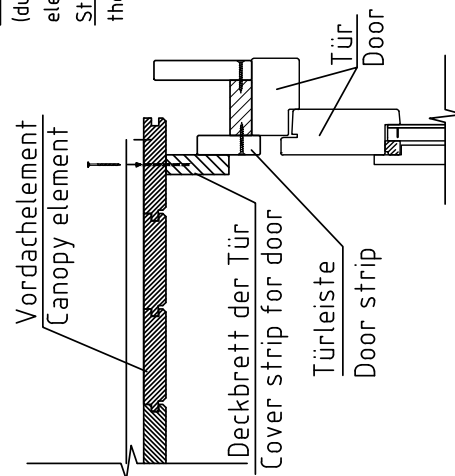

Step 3: Die Verkleidungsleisten in die richtige Länge schneiden und unter das VD-Element befestigen.
Step 3: Cut trim strips to size and fasten under the canopy element.

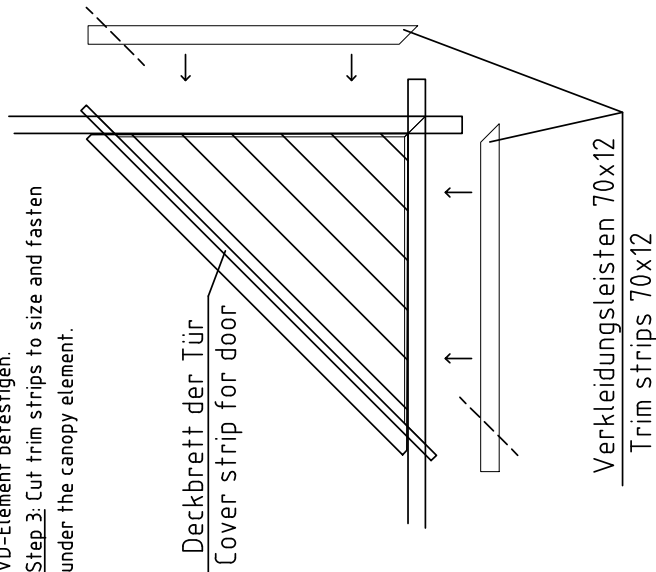

Vordachelement/Canopy element

Schnitt / Section

Details 558205

Montageanleitung für T-Leisten / Installing the door and window supports / Tenderliistu paigaldusjuhend.

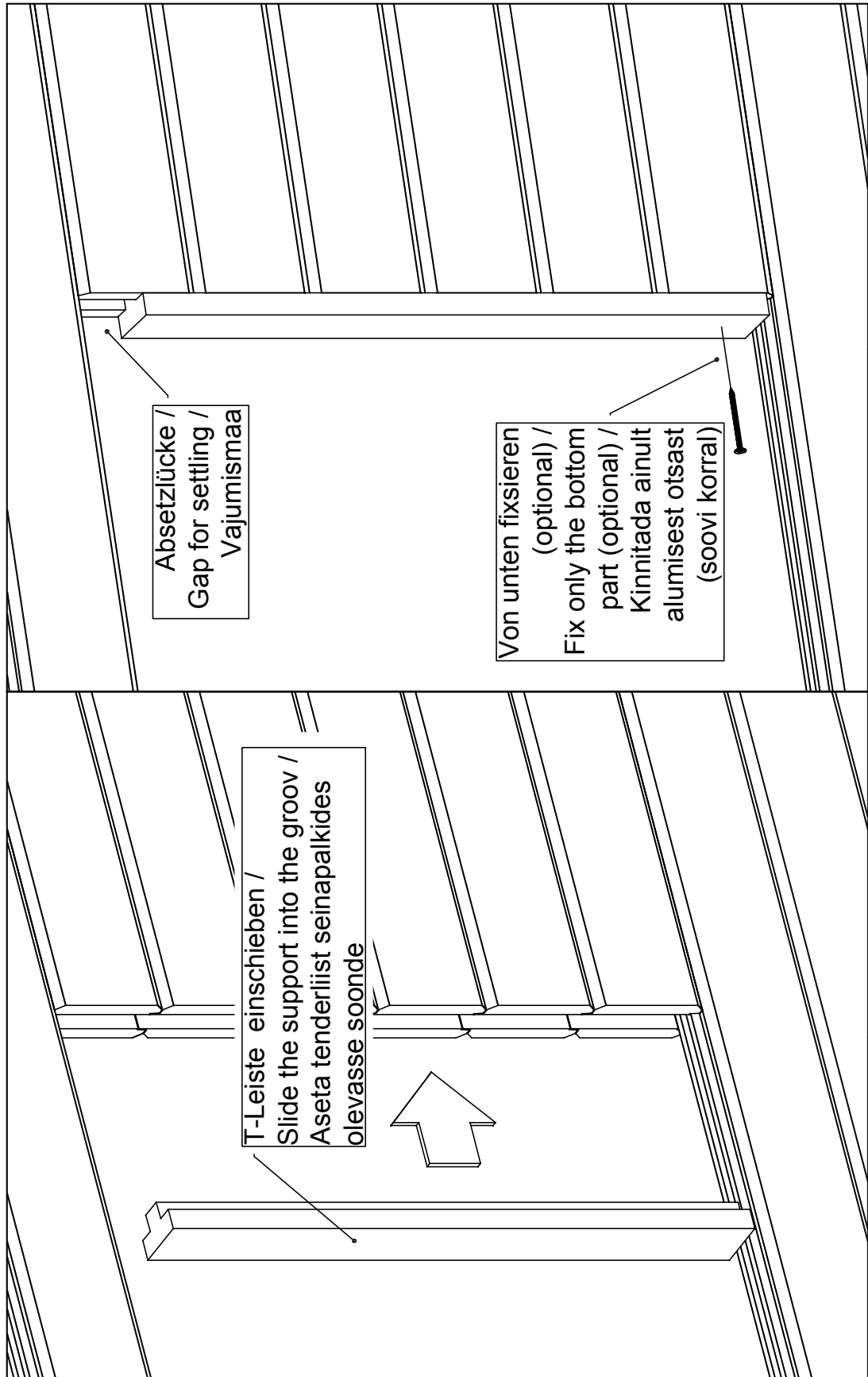

Details 558205

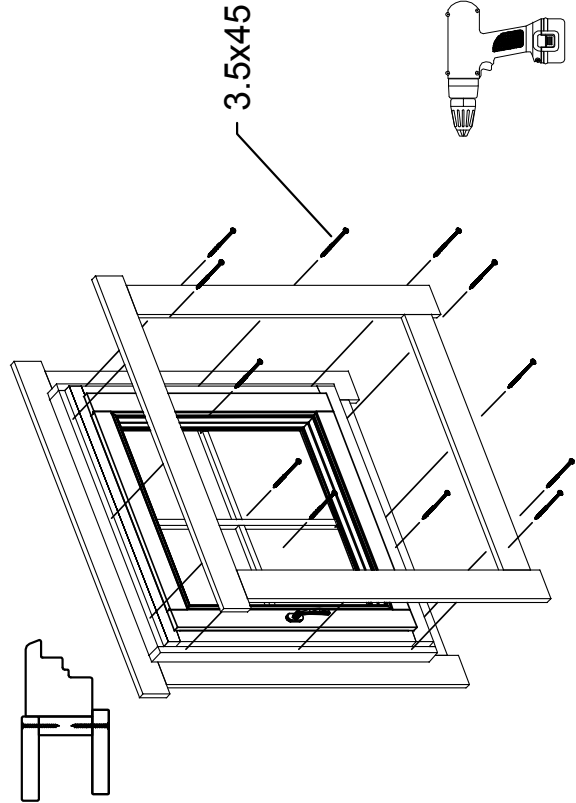
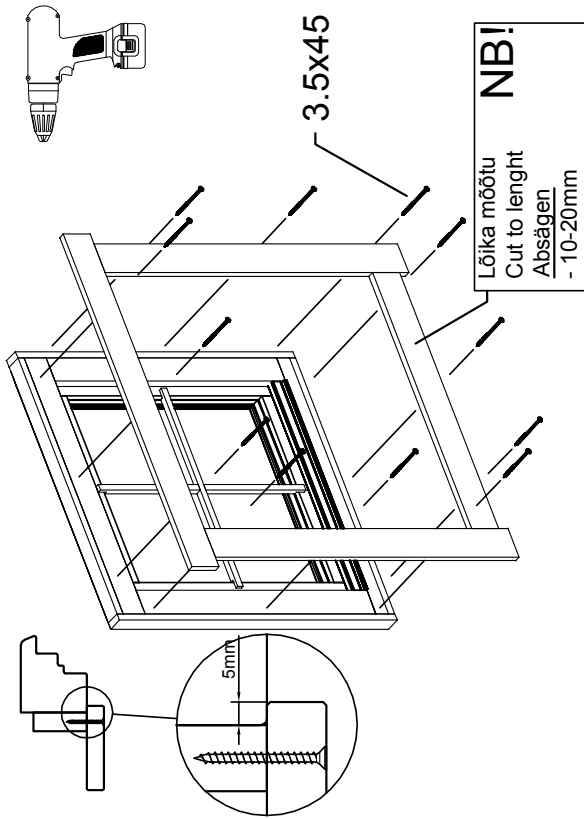

Akna tüüp / Fenster typ / Window type - A68
(GH+ / SH)

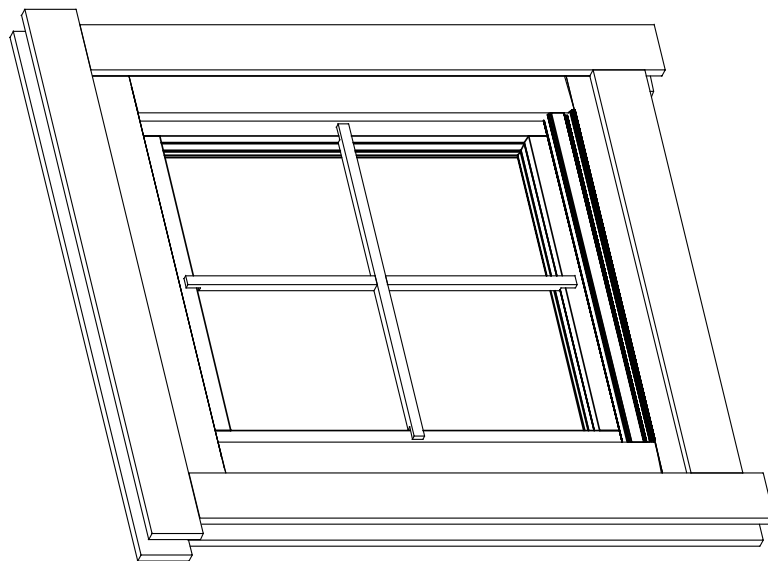

Details 558205



Ukse montaaž / Tür montage / Door assembly
(GH+ / SH)

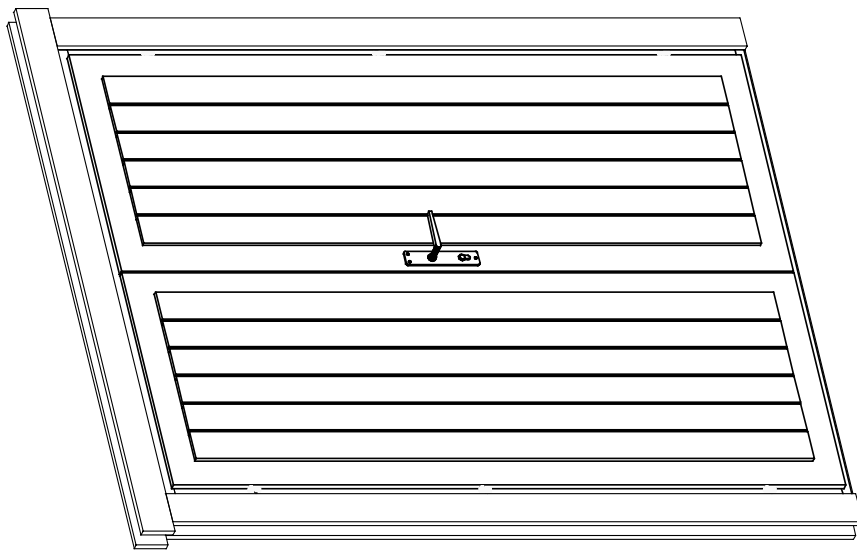

Details 558205

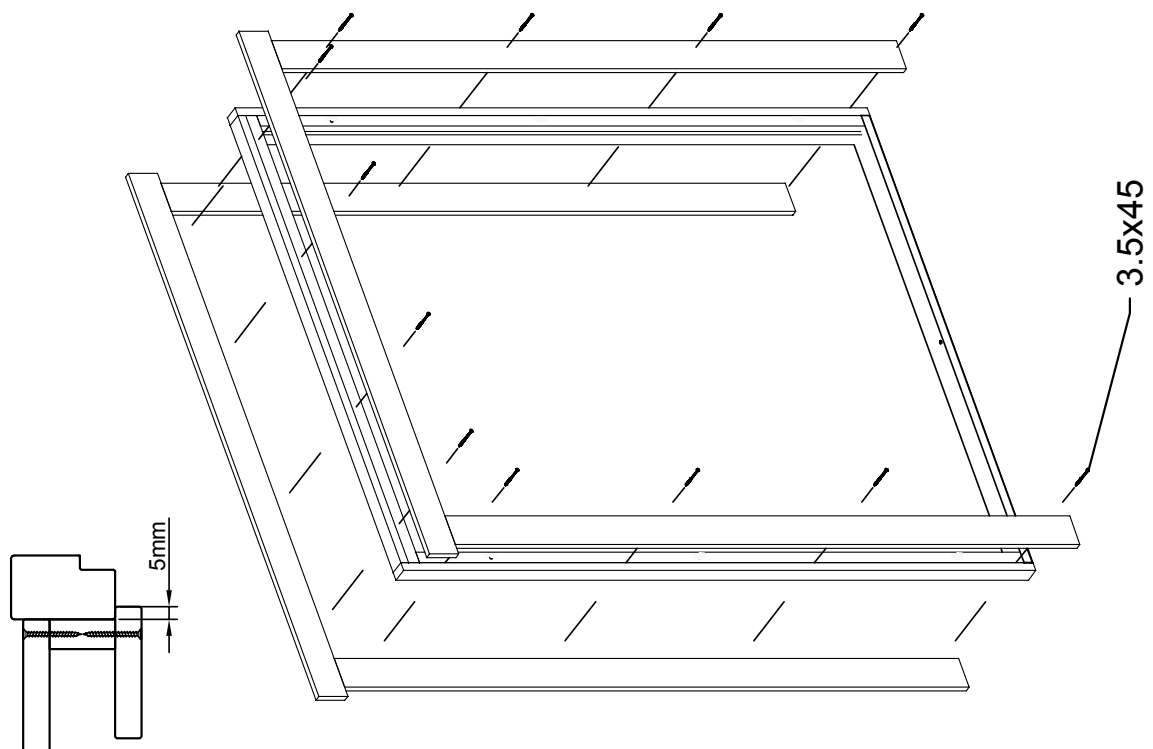
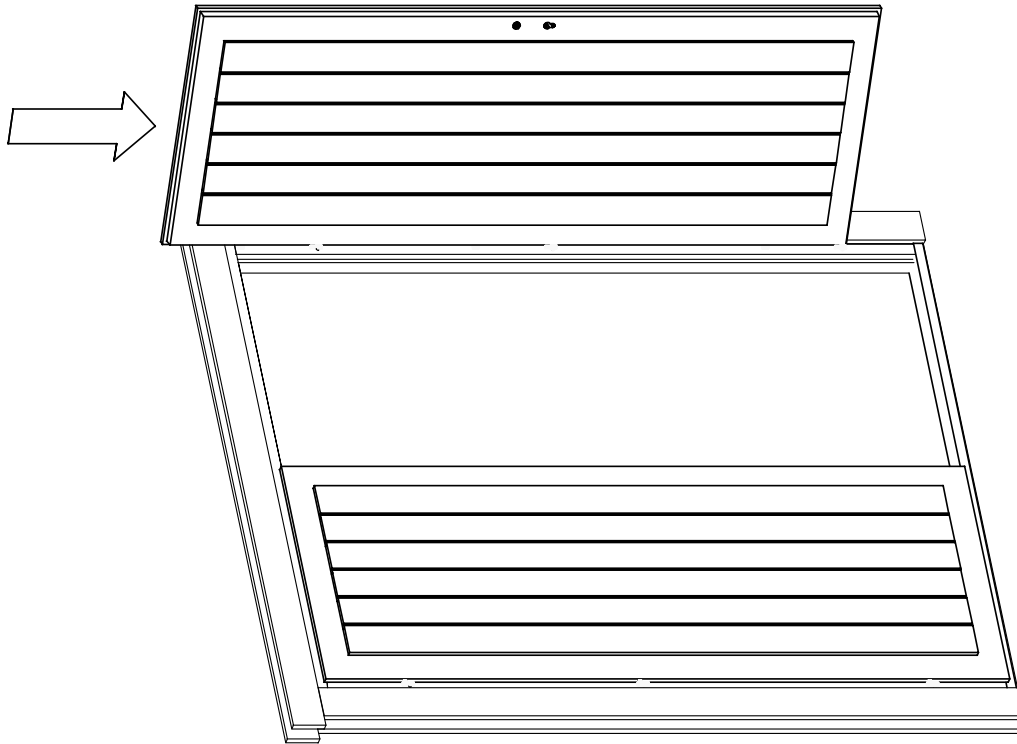

Details 558205

