

Technische Daten Katrin 44-B

Wandaußenmaß: 360 x 360 cm

Bohlenstärke: 44 mm



Kontrolliert durch:

Achtung: Alle angegebenen Maße sind ca.-Maße!

3D-Darstellung und Grundriss Katrin 44-B

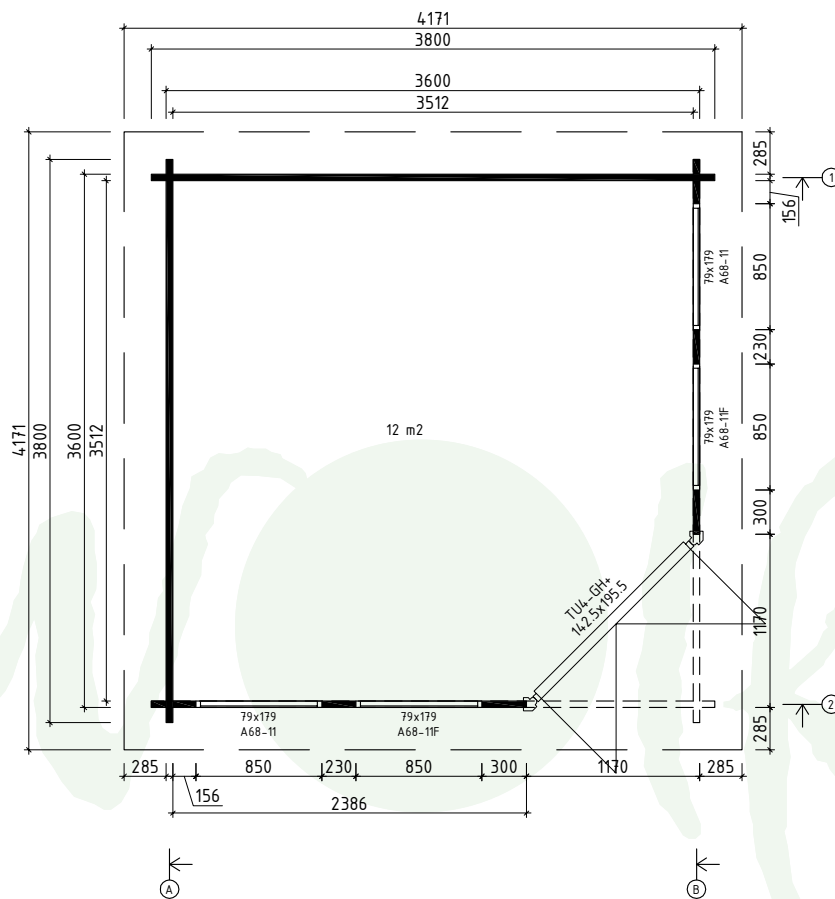
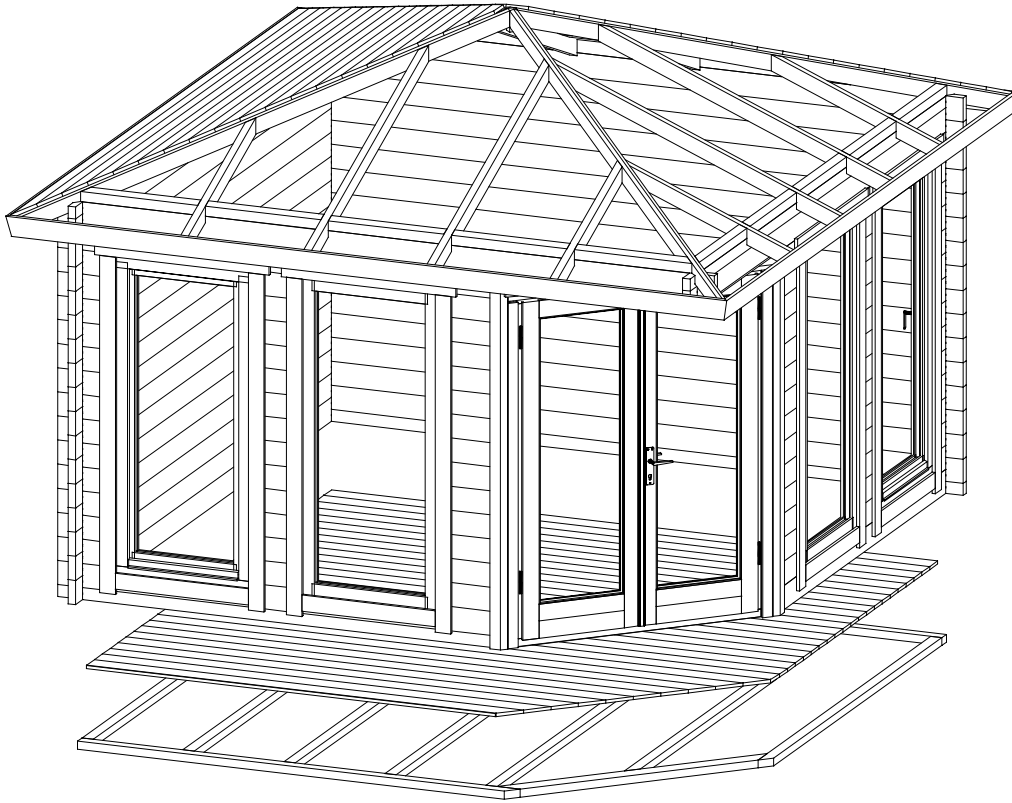

*Fenster und Türen sind ohne Sprossen

Lagerholzplan und Fundamentplan Katrin 44-B

Wir empfehlen als Fundament für Ihr Gartenhaus eine vollflächig festgegründete gepflasterte oder betonierte Fläche.
Wahlweise ist auch ein Punkt- oder Streifenfundament möglich.

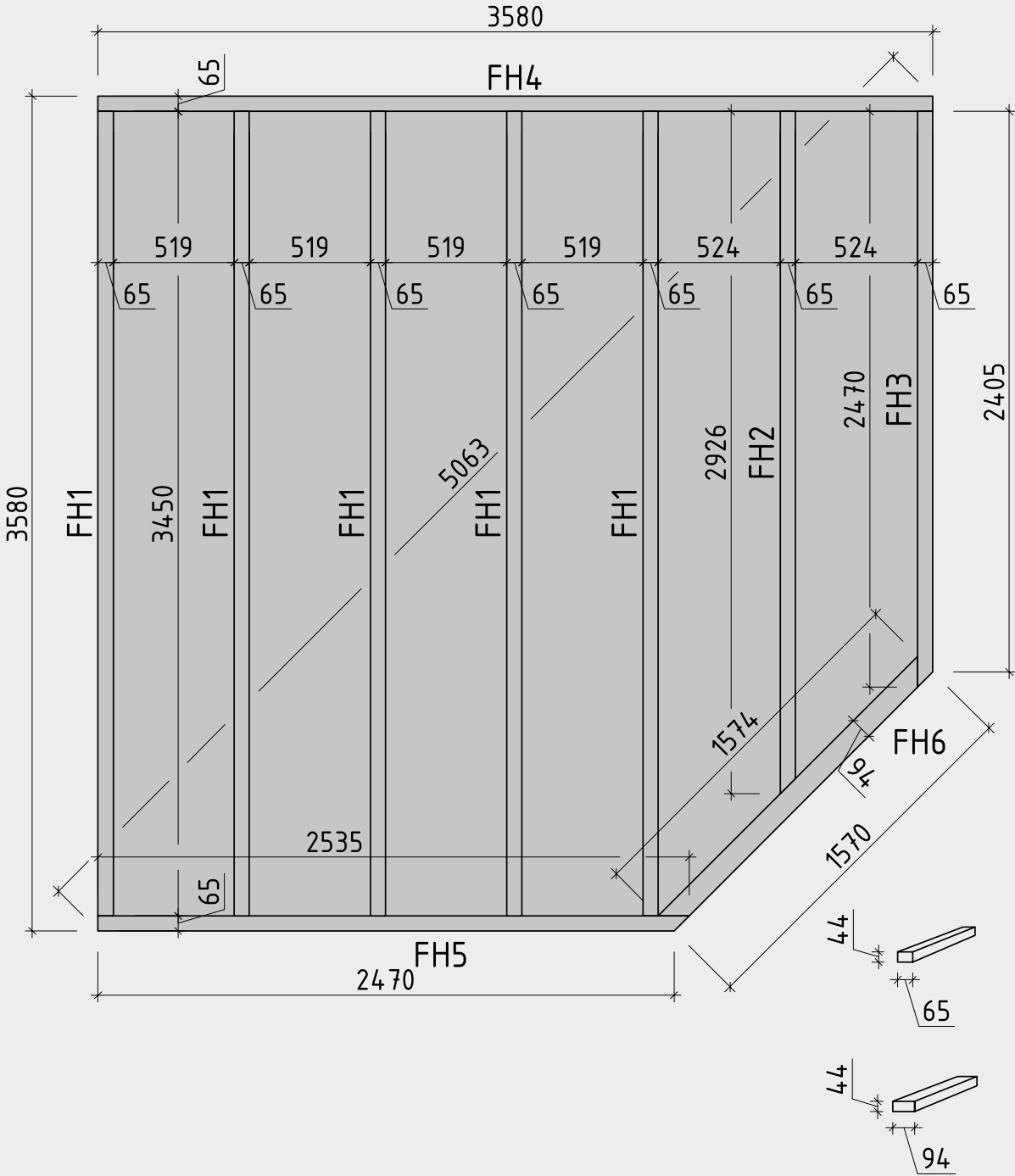



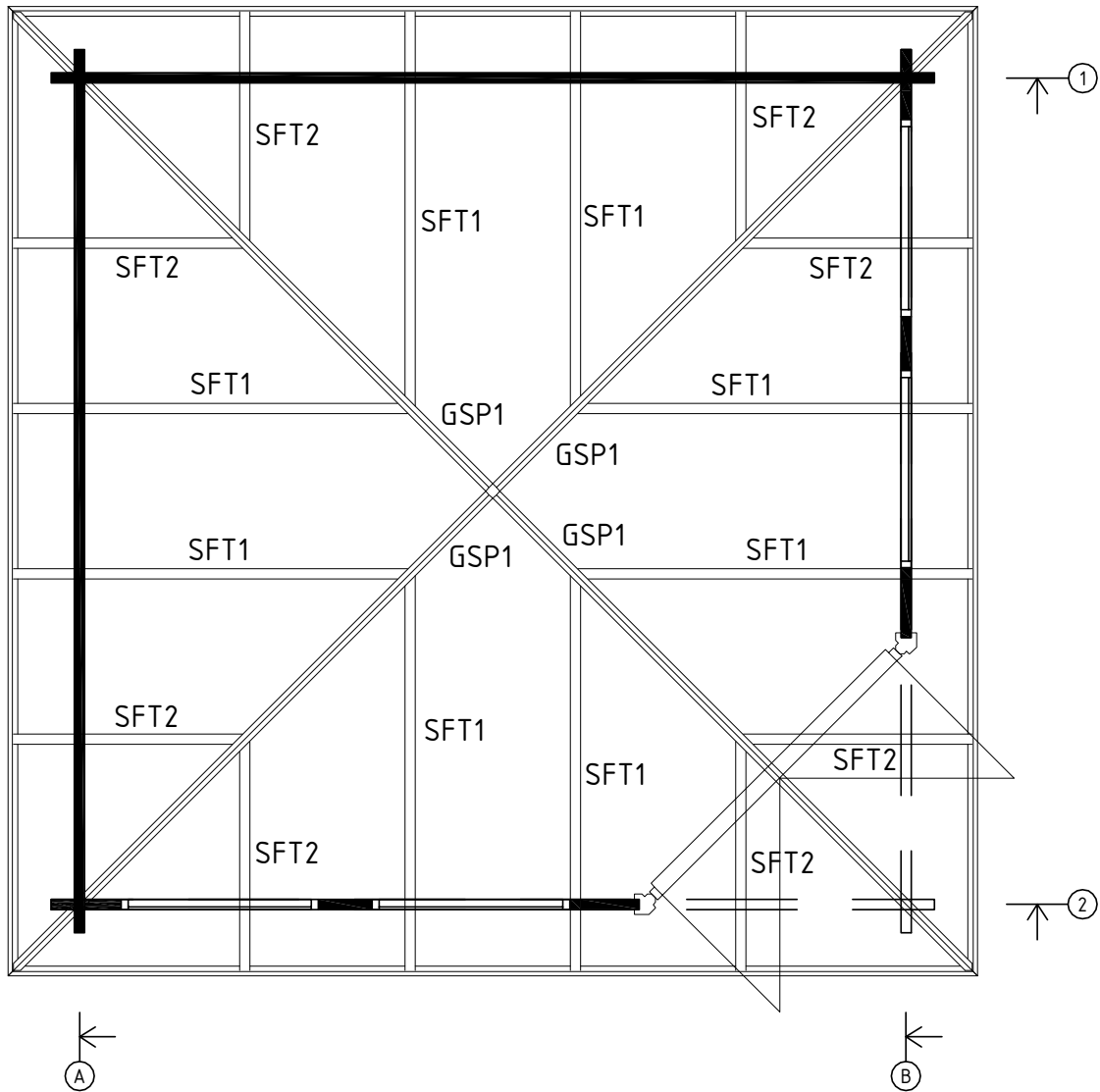





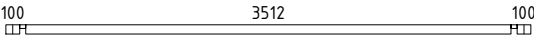
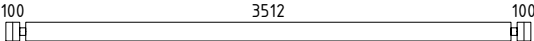
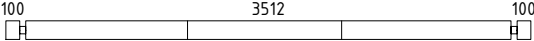
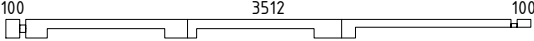
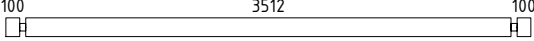
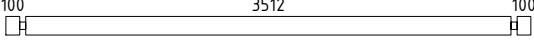
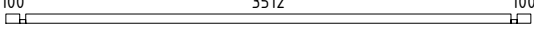
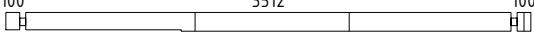
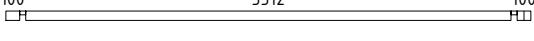
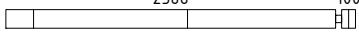
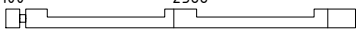
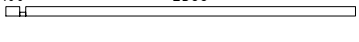

Dachbalkenplan Katrin 44-B







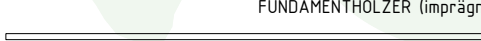
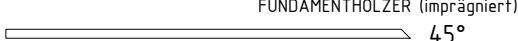
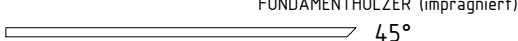

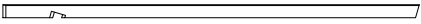

Teileliste 1

Katrin 44-B

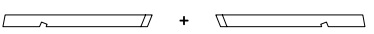
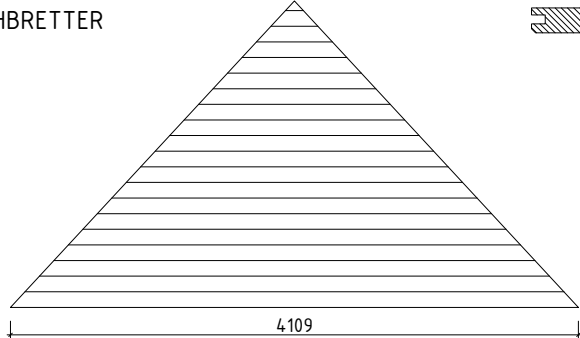
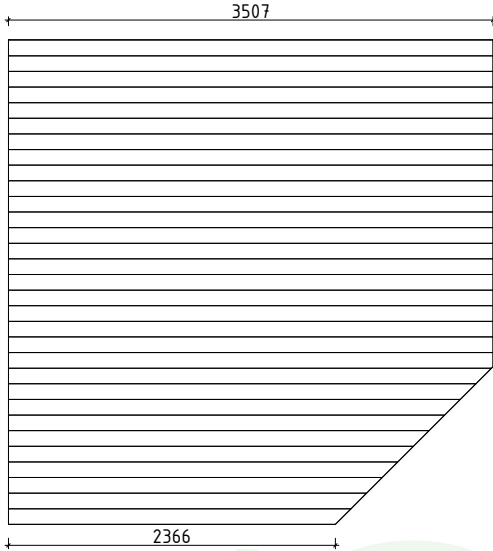
Pos		Stck	Profil (mm)	Länge (mm)
001		1	44x68	3800
002		16	44x135	3800
003		1	44x135	3800
004		1	44x135	3800
005		1	44x135	3800
006		15	44x135	3800
007		1	44x68	3800
008		1	44x135	3800
009		1	44x68	3800
010		1	44x135	2530
011		1	44x135	2530
012		1	44x68	2530
013		4+4	44x74	679
014		12	44x74	668
015		14	44x135	300
016		13	44x135	300
017		23	44x135	300
018		4	44x135	300
019		23	44x135	230
020		4	44x135	230
FH6		1	94x44	1574
FH4		1	65x44	3580
FH1		5	65x44	3450
FH2		1	65x44	2926
FH5		1	65x44	2535



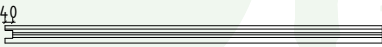

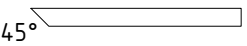



Teileliste 2

Katrin 44-B

Pos		Stck	Profil (mm)	Länge (mm)	
FH3	FUNDAMENTHÖLZER (imprägniert)  45°	1	65x44	2470	
GSP1	GRATSPARREN 	4	44x94	3013	
SFT1	SCHIFTER 	4+4	44x85	1847	
SFT2	SCHIFTER 	4+4	44x85	1080	
	DACHBRETTER 	4	113x18		
	FUSSBODENBRETTER 	1	113x18	21+1 singed/ ohne Ecke 11 nurk 45°/ mit Ecke	
	FUSSBODENLEISTE 	✓	18x40	14,0 lfm	
T1-1	TRAUFENBRETTER 120X18 	✓	4	120x18	4270
	Zentralverbindungselement (Dach) 	1	44x44	90	
P9L-1	ECKTÜR- linke Türpfoste 90 	1	90x90	2045	
P9R-1	ECKTÜR- rechte Türpfoste 90 	1	90x90	2045	
DzT 40-1	ECKTÜR- Deckbrett zum Tür 40 	1	18x40	1585	
VK-1	ECKTÜR- Verkleidungsleisten für Vordachelement 	✓	2	58x12	1110

Teileliste 3

Katrin 44-B

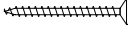
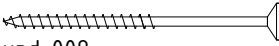
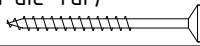
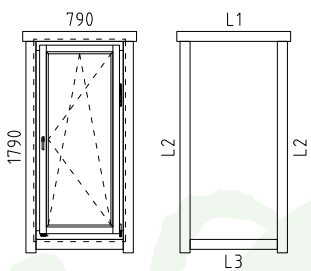
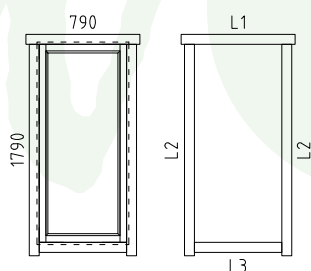
Pos		Stck	Profil (mm)	Länge (mm)
VE1	ECKTÜR- Vordachelement 1435x745		1	
SH	Schlaghölzer		3	
ML1	Metallstange		8	D10 1170
KL1	Gewindestange M8		3	M8 2000
KL2	Gewindestange M8		3	M8 258
	Mutter M8 U-Scheibe Ø25		6	M8
	Befestigungsmutter M8		3	M8
NG1	NÄGEL 2.5x50 Dachbretter Fussbodenbretter		1208	
SR01	SCHRAUBEN 3.0x30 Fussbodenleisten		30	
SR03	SCHRAUBEN 3.5x45 Deckbrett, Vordachelement Verkleidungsleisten, Traufenbretter Fenster- und Türleisten		186	
SR11	SCHRAUBEN 5.0x100 Fundamenthölzer Wandbalken pos 013, 014, 004 und 009 Gratsparren und Schiffer -> Wand		107	
SR10	SCHRAUBEN 5.0x70 Pos 010 und 012 (1. Bohlenreihe neben die Tür) Schiffer -> Gratsparren		20	
	<p>FENSTER 790x1790</p>  <p>A68-11</p> <p>L1 18x90 L=1030mm 2 Stck. L2 18x90 L=1910mm 4 Stck. L3 18x90 L=790mm 2 Stck. ✓</p> <p>DIN 1xrechts/1xlinks</p>		2	
	<p>FENSTER 790x1790</p>  <p>A68-11F</p> <p>L1 18x90 L=1030mm 2 Stck. L2 18x90 L=1910mm 4 Stck. L3 18x90 L=790mm 2 Stck. ✓</p>		2	

Teileliste 4

Katrin 44-B

Pos		Stck	Profil (mm)	Länge (mm)												
	TÜR 1425x1955	1														
	<p>TU4-GH+</p> <table style="font-size: small;"> <tr> <td>L1</td> <td>18x90</td> <td>L=1540mm</td> <td>1 Stck.</td> </tr> <tr> <td>L2</td> <td>18x58</td> <td>L=1540mm</td> <td>1 Stck.</td> </tr> <tr> <td>L3</td> <td>18x58</td> <td>L=1955mm</td> <td>4 Stck. ✓</td> </tr> </table> <p>DIN rechts</p>	L1	18x90	L=1540mm	1 Stck.	L2	18x58	L=1540mm	1 Stck.	L3	18x58	L=1955mm	4 Stck. ✓			
L1	18x90	L=1540mm	1 Stck.													
L2	18x58	L=1540mm	1 Stck.													
L3	18x58	L=1955mm	4 Stck. ✓													
	✓ - bitte selber anpassen (falls nötig)!															

Zuschnitt Fußboden Katrin 44-B

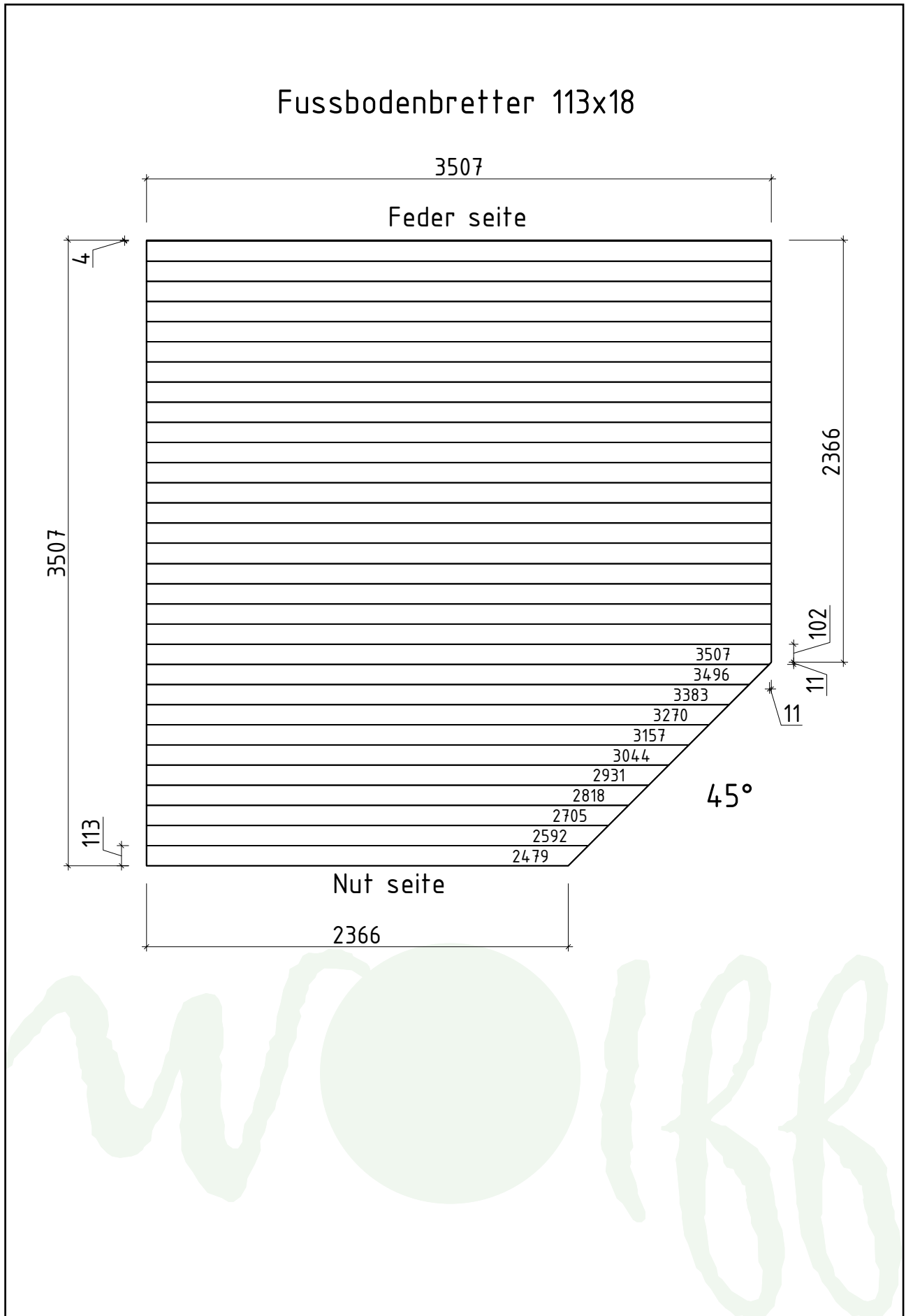

Wandplan 1 und 2

Katrin 44-B

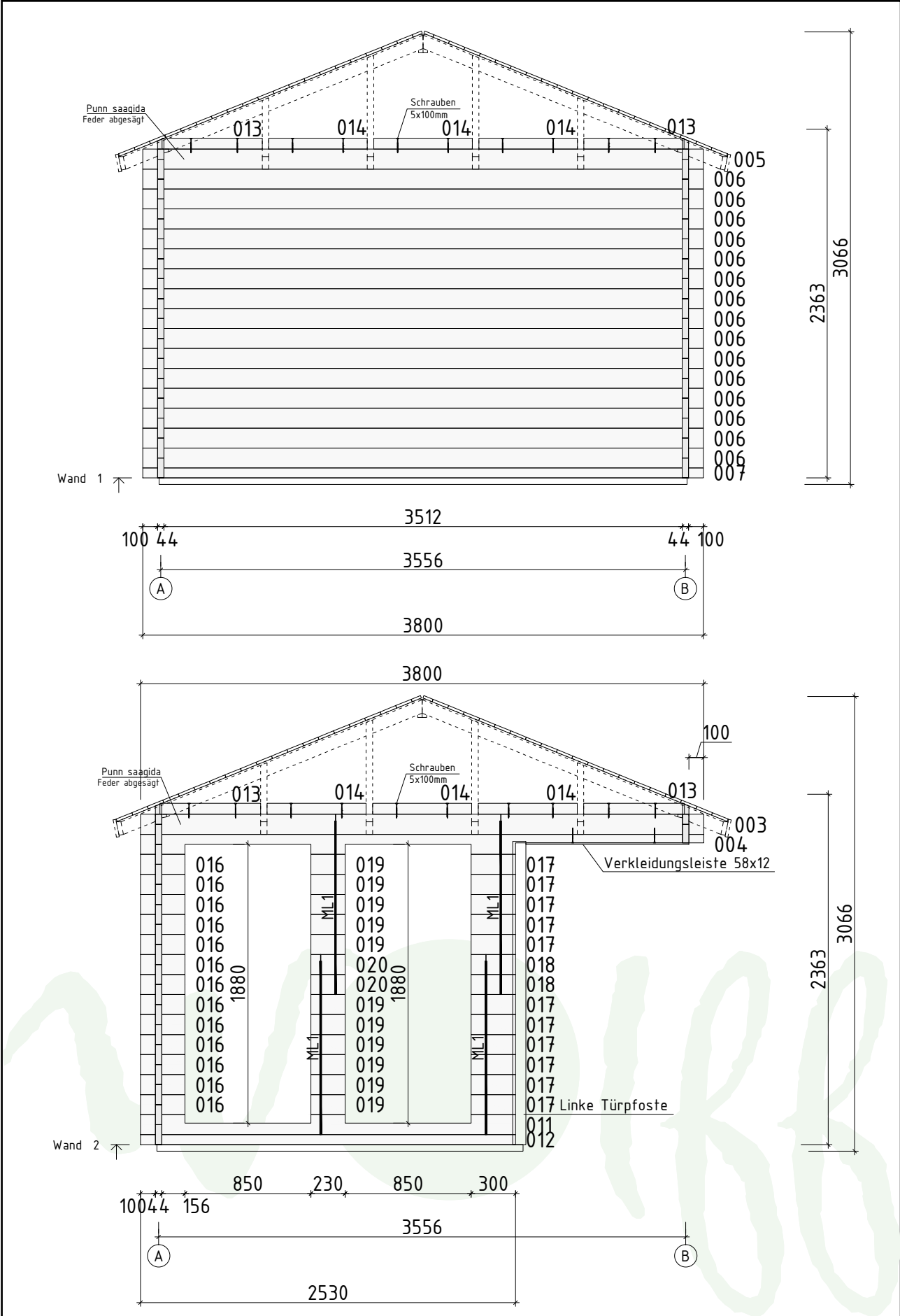

Wandplan A und B Katrin 44-B

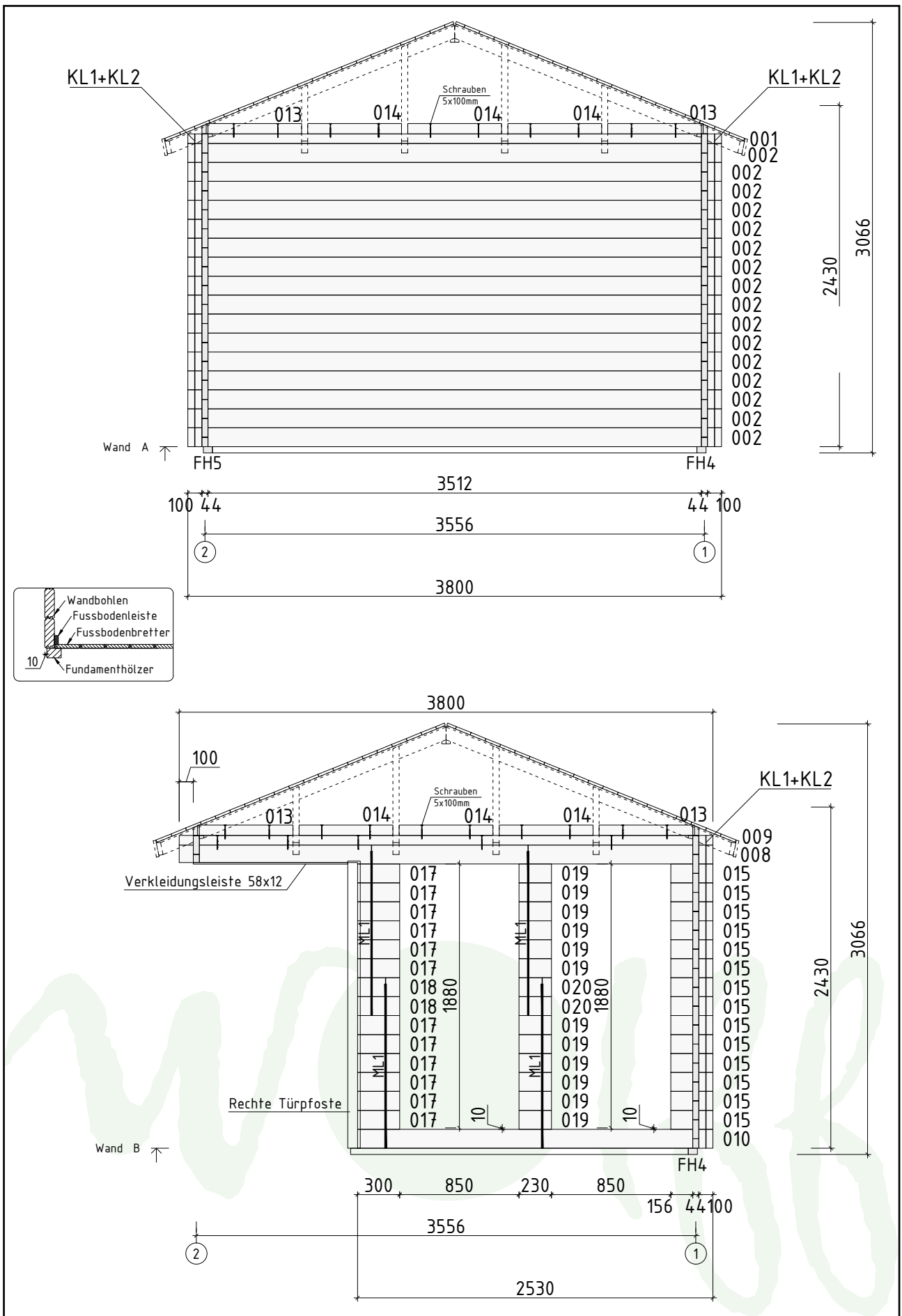

Detailansicht Vordachelement Katrin 44-B

Step 1: Dachelement an den Wänden verschrauben.
Step 1: Screw canopy element to the wall.

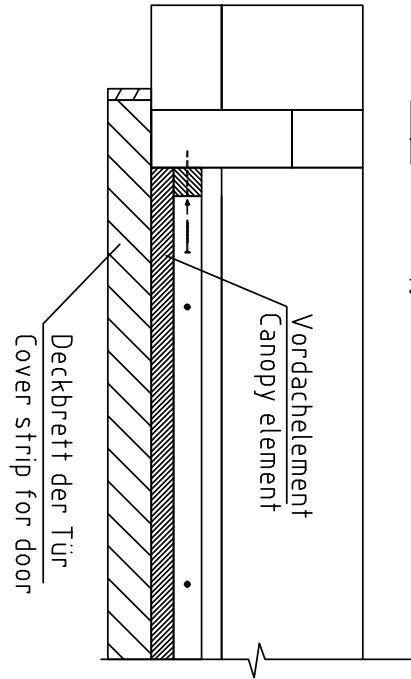

Step 2: Das Deckbrett muss von oben (durch das VD-Element) an das Dachelement verschraubt werden.
Step 2: Fasten cover strip to the canopy element.

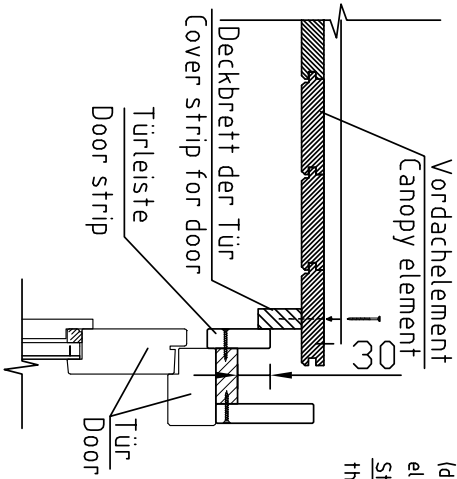

Step 3: Die Verkleidungsleisten in die richtige Länge schneiden und unter das VD-Element befestigen.
Step 3: Cut trim strips to size and fasten under the canopy element.

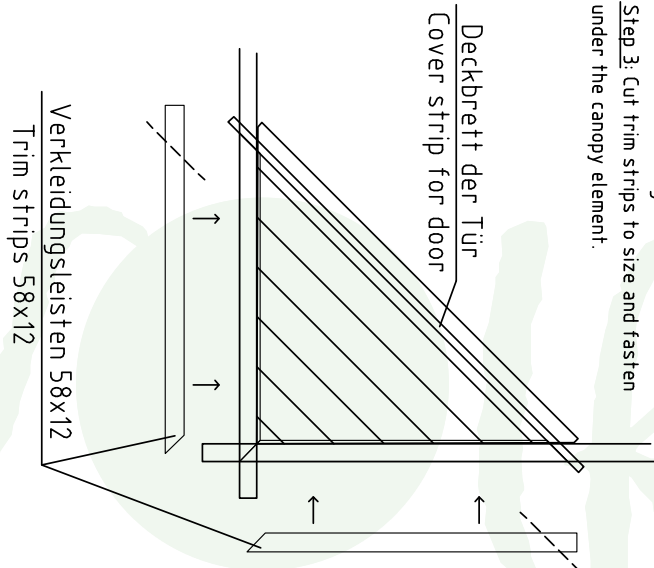

Vordachelement/Canopy element

Schnitt/Section

Fenster und Türdetails Katrin 44-B

Akna tüüp / Fenster typ / Window type - A68
(GH+ / SH)

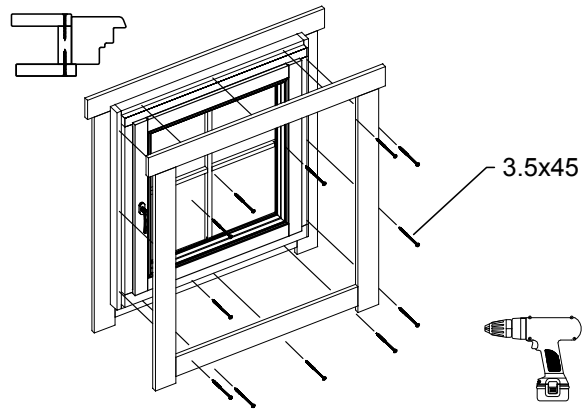
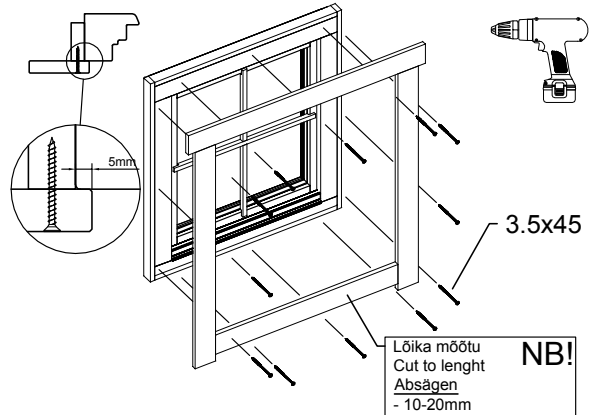
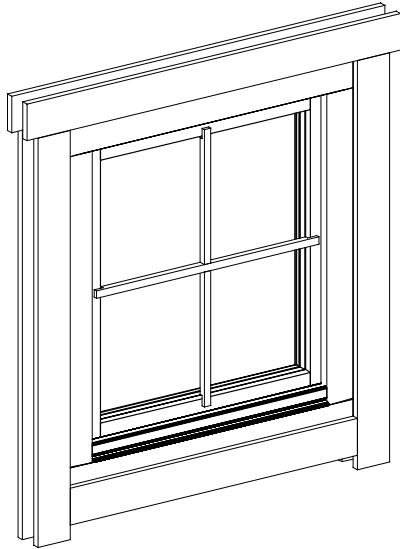

Ukse montaaž / Tür montage / Door assembly
(GH+ / SH)

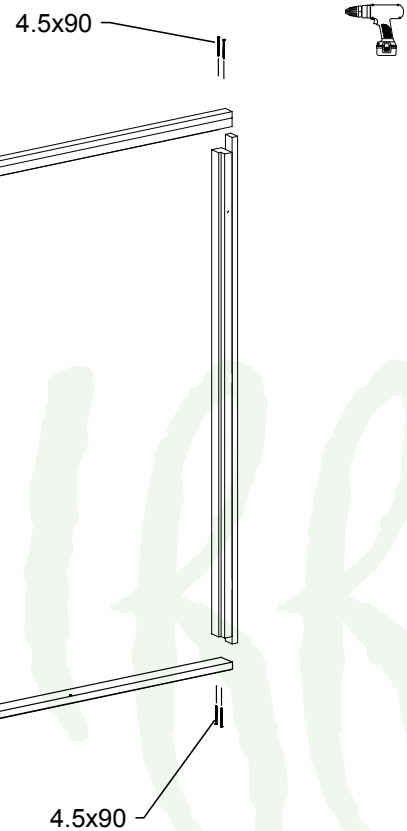
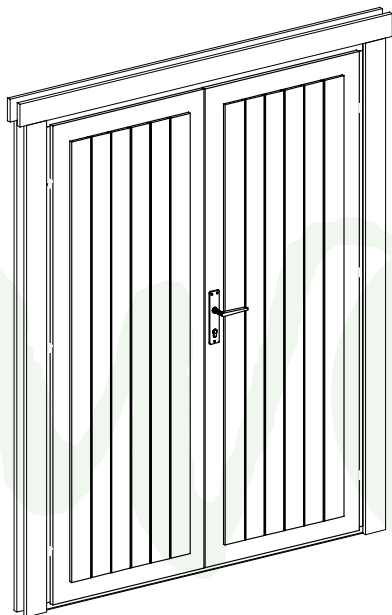

Fenster und Türdetails Katrin 44-B

