

Technische Daten Nancy

Wandaußenmaß: 450 x 300 cm

Bohlenstärke: 40 mm



Kontrolliert durch:

Achtung: Alle angegebenen Maße sind ca.-Maße!

3D-Ansicht Nancy

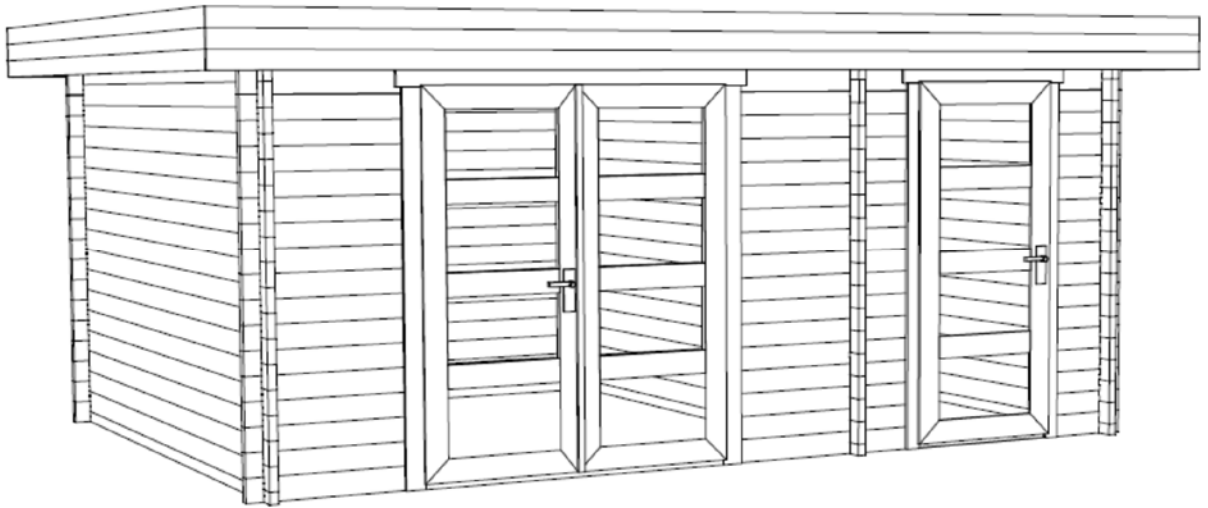

Grundriss 1 Nancy

Groundplan - Grundplan - Plan de masse - Planimetria -
Plattegrond - Pöhiplan

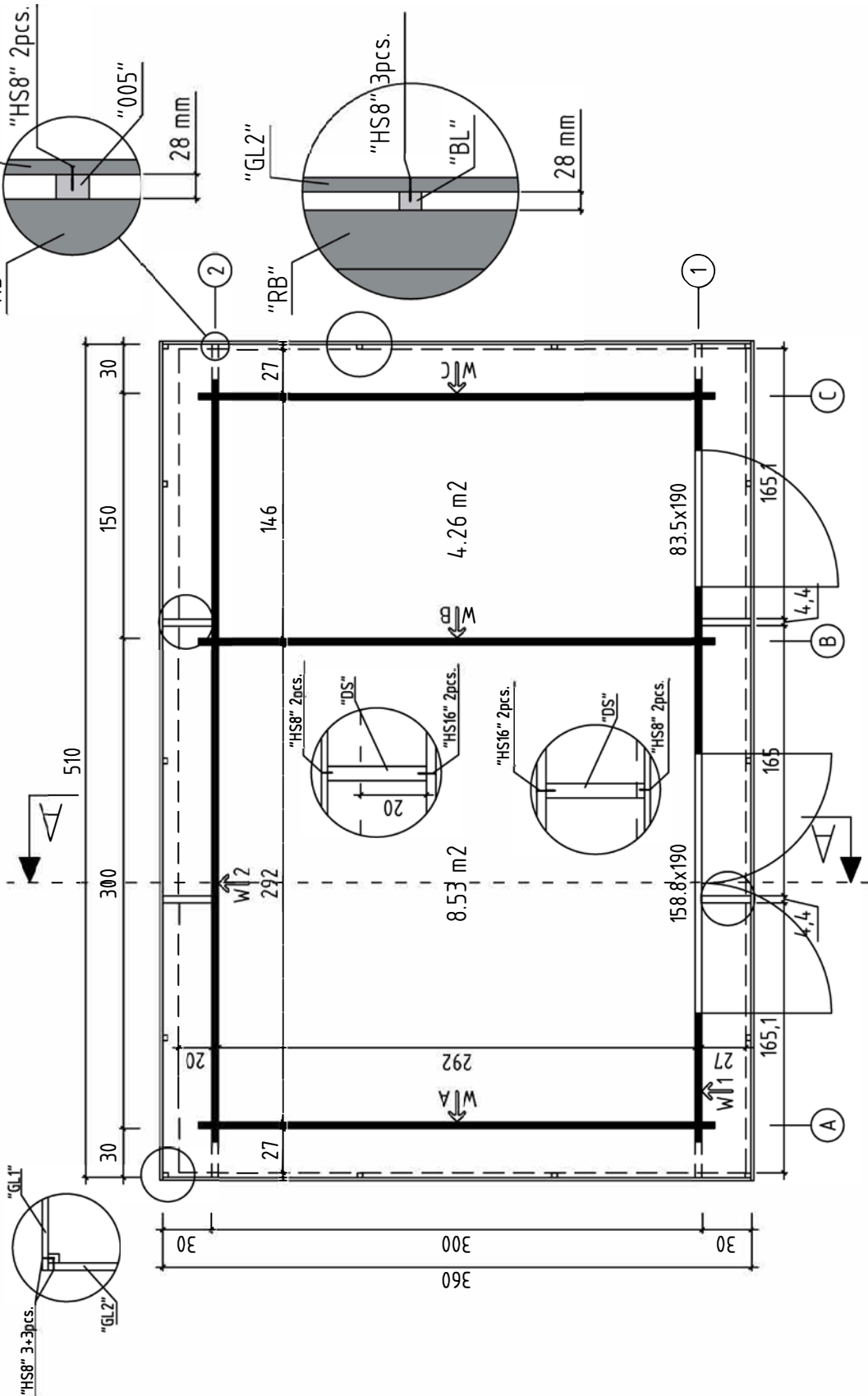

Grundriss 2 Nancy

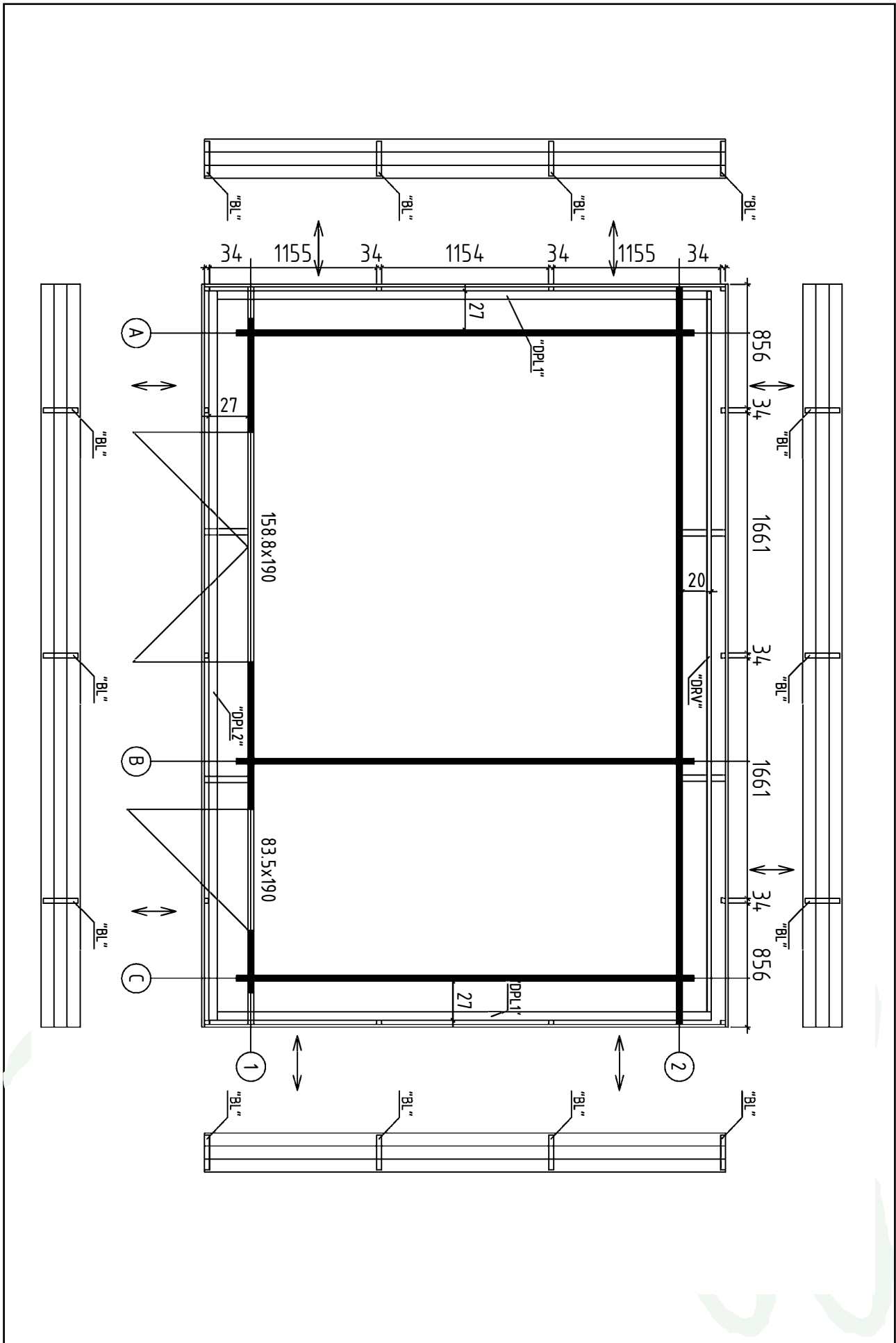



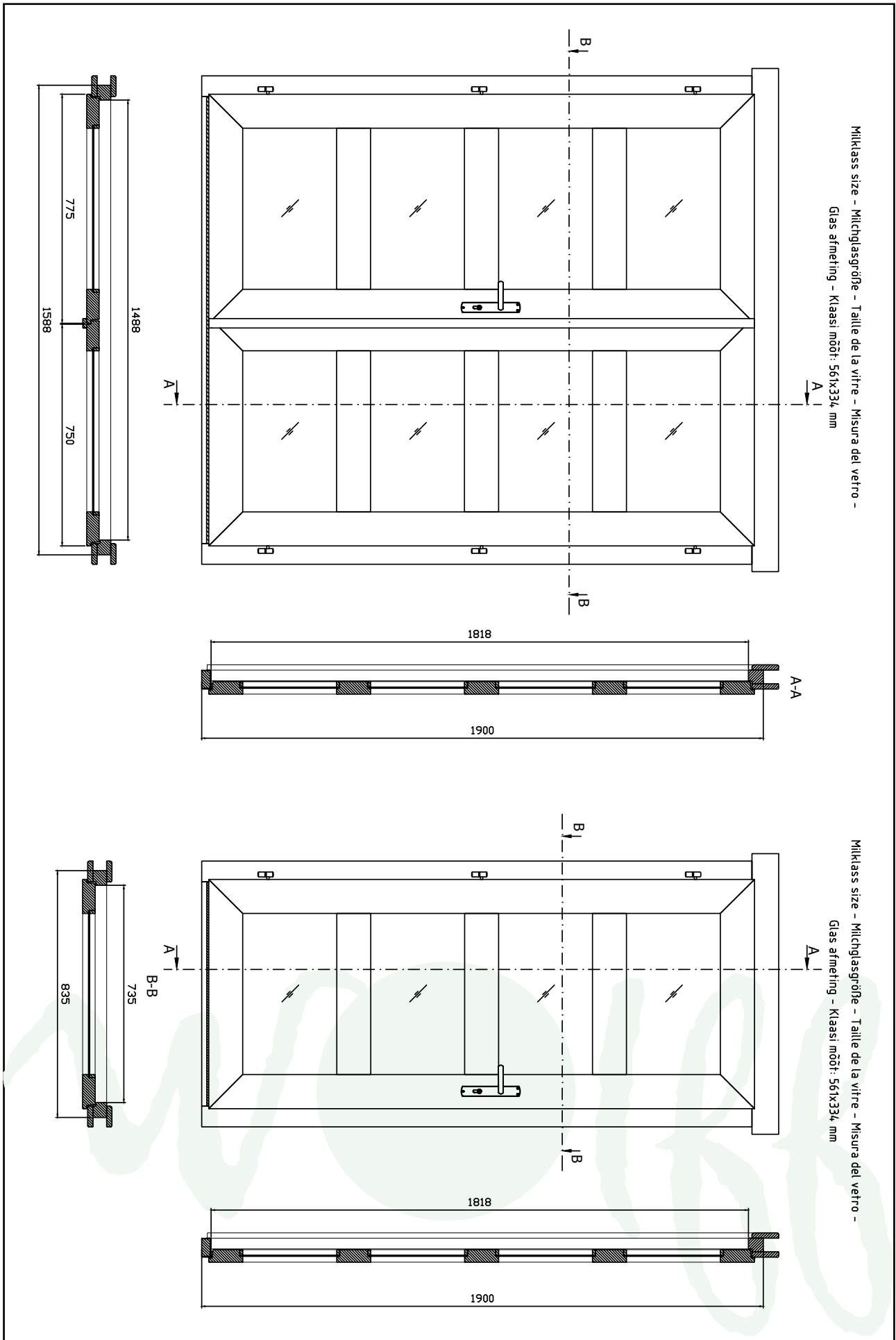





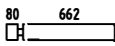
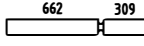

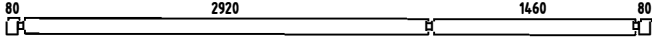
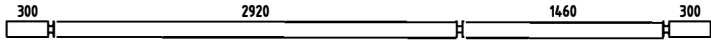
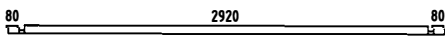
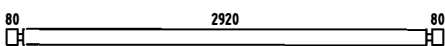
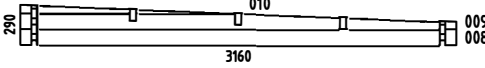
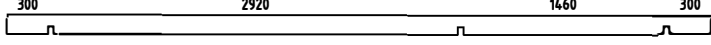



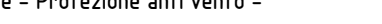

Fenster- und Türdetails Nancy

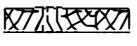
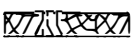

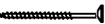





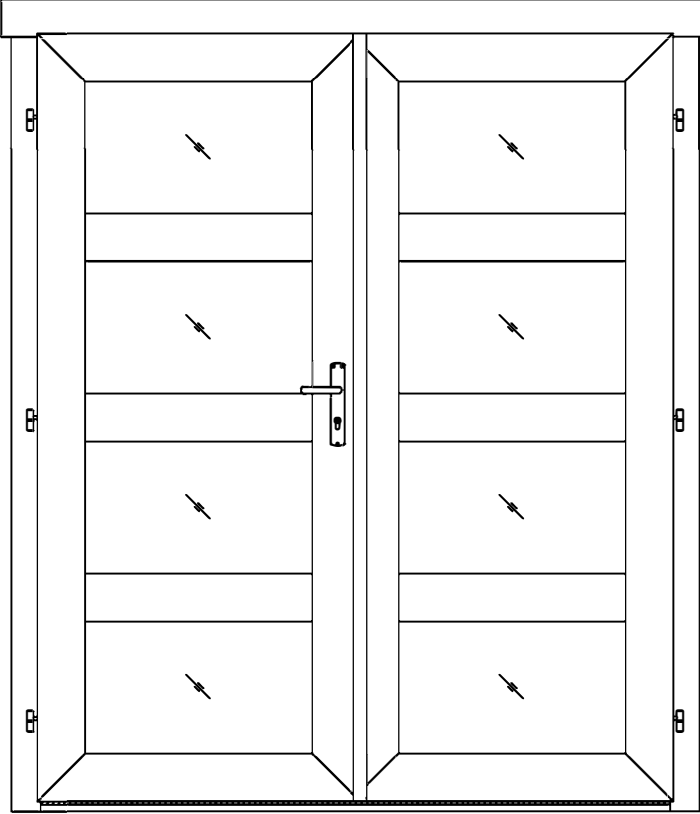
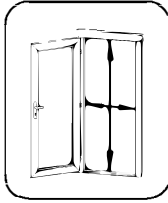

Teilleiste 1

Nancy

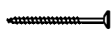
Pos		Q	P (mm)	L (mm)
001		17	40x114	782
002		17	40x114	1011
003		17	40x114	428
004		18	40x114	4660
005		2	40x114	5100
006		3	40x57	3160
007		48	40x114	3160
WA-1 WB-1 WC-1		1 1 1		
PR21	 Roof beam - Dachbalken - Panne de toit - Perlina del tetto - Gordingen / dakbalk - Pärilin	3	44x140	5100
RB	Roof boards - Dachbretter - Voliges - Perlina per tetto - Dakhout - Katuselaud 	57	90x18	3473
DPL1	Roofing felt fillet - Dachpappenteiste - Baguette de fixation du feutre bitumeux - Asse per fissaggio guaina bituminosa - Afdekljst asfaltpapier - Katusepapiilist 	2	18x58	3412
DPL2	Roofing felt fillet - Dachpappenteiste - Baguette de fixation du feutre bitumeux - Asse per fissaggio guaina bituminosa - Afdekljst asfaltpapier - Katusepapiilist 	1	18x58	5040
DRV	Roof edge reinforcement - Dachrandverstärkung - Corniere de renfort de bord de toit - Rinforzo x tetto - Dakrand versterking - Räästatugevdus 	2	28x34	2520
KFS-1	Storm protection - Sturmleiste - Latte anti-tempete - Protezione anti vento - Stormverankering / beveiliging - Tormikinnitusliist 	2	22x45	2050
KFS-2	Storm protection - Sturmleiste - Latte anti-tempete - Protezione anti vento - Stormverankering / beveiliging - Tormikinnitusliist 	2	22x45	2500
BL	Fixing slat for gable moulding - Befestigungsleiste - Renforts planches de rives - Stecca per fissare i distanziatori - Bevestigingslat afstandhouders - Viilulaua kinnitus 	14	28x34	240
GL2	Gable moulding - Giebelleiste - Planche de rive - Finitura per frontale e retro del tetto - Gevelljst - Viilulaud 	6	18x90	3600
GL1	Gable moulding - Giebelleiste - Planche de rive - Finitura per frontale e retro del tetto - Gevelljst - Viilulaud 	6	18x90	5136
DS	Distance spacers for gable moulding - Dachstützen - Supports extension toiture - Distanziatori per la modanatura del timpano - Daksteun / afstand houder - Viilulaudade distantasklots 	4	44x95	300
HS8	Screw for gable moulding - Schrauben für giebelleiste - Vis pour fixation planche de rive - Vite per fissare finiture davanti e dietro del tetto - Schroef voor gevellijst - Kruvi viilulauale 	70	3.5x35	
HS12	Screw for roof edge reinforcement - Schrauben für dachrandverstärkung - Vis pour fixation corniere renfort de bord de toit - Viti x rinforzo bordo tetto - Schroef voor dakrand versterking - Kruvi räästatugevdusele 	12	4x40	
HS18	Screw for roof beams - Schrauben für dachbalken - Vis pour fixation pannes de toit - Viti per perline del tetto - Schroef voor gordingen / dakbalken - Kruvi pärlineitele 	15	5x120	
HS18	Screw for gable - Schrauben für giebel - Vis pour fixation des pignons - Viti per timpano - Schroef voor gevelpunt - Kruvi viilude kinnitamiseks 	12	5x120	



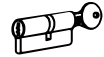
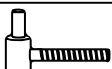



Teileliste 3

Nancy

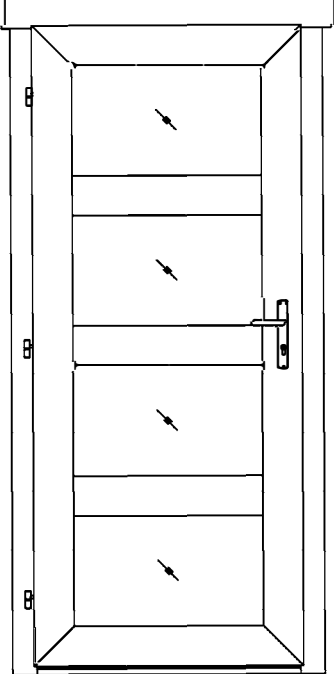
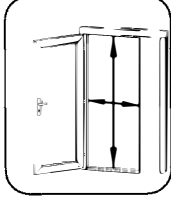
Pos		Q	P (mm)	L (mm)
	<p>Glass size – Glasgröße – Taille de la vitre – Misura del vetro – Glas afmeting – Klaasi mõõt: 561x334 mm</p>   <p>1488x1818 mm</p>			
HS4	<p>Screw for door fillet – Schraube zur Befestigung türleiste – Vis pour fixation baguette d'arrêt de porte – Viti per massellino della porta – Schroef voor deurlijst – Krugi ukse kokkuvaltšiliistule</p> 	5	3x30	
HS16	<p>Screw for door jamb – Schraube für Türrahmen – Vis de fixation partie haute avec montants du cadre de porte – Viti x fissaggio montanti porte – Schroef voor deurkozijn – Krugi ukse lengile</p> 	4	5x90	
HS25	<p>Screw for doorstep – Schrauben für swelle – Vis pour fixation barre de seuil – Vite per soglia della porta – Schroef voor deurdorpel – Krugi lävepakule</p> 	3	4.5x65	
TL4	<p>Door handle fittings – Türgriff – Poignée de porte – Maniglie – Deurhendel / klink – Ukse käepide</p> 	1		
TL5	<p>Set of door lock covers – Schlossblenden – Set de garnitures de porte – Copertura serrature – Slot sluitplaat set – Ukse lukuplaat</p> 	1		
	<p>Cylinder lock – Zylinderschloss – Barillet de porte – Serratura – Cylinder slot – Ukse lukusüdamik</p> 	1	30x35	
	<p>Male bolt hinge for door – Türband – Partie male de paumelle de porte – Cerniera anube x porta – Scharnier bout – Ukse polthing isane</p> 	6		
	<p>Striker for barrel bolt – Hülse für Grendelriegel – Gache au sol du targette – Boccola per fermo della porta – Huls voor vergrendelingschuif – Vasturaud ukse servariivile</p> 	2		

Teileliste 4

Nancy

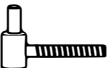
Pos		Q	P (mm)	L (mm)
	<p>Glass size - Glasgröße - Taille de la vitre - Misura del vetro - Glas afmeting - Klaasi mõõt: 561x334 mm</p>   <p>735x1818 mm</p>			
HS16	<p>Screw for door jamb - Schraube für Türrahmen - Vis de fixation partie haute avec montants du cadre de porte - Viti x fissaggio montanti porte - Schroef voor deurkozijn - Kruvi ukse lengile</p> 	4	5x90	
HS25	<p>Screw for doorstep - Schrauben für swelle - Vis pour fixation barre de seuil - Vite per soglia della porta - Schroef voor deurdorpel - Kruvi lävepakule</p> 	2	4.5x65	
TL4	<p>Door handle fittings - Türgriff - Poignée de porte - Maniglie - Deurhendel / Klink - Ukse käepide VU</p> 	1		
TL5	<p>Set of door lock covers - Schlossblenden - Set de garnitures de porte - Copertura serrature - Slot sluitplaat set - Ukse lukuplaat</p> 	1		
	<p>Cylinder lock - Zylinderschloss - Barillet de porte - Serratura - Cylinder slot - Ukse lukusüdamik</p> 	1	30x35	
	<p>Male bolt hinge for door - Türband - Partie male de paumelle de porte - Cerniera anube x porta - Scharnier bout - Ukse polthing isane</p> 	3		

Wandplan 2 Nancy

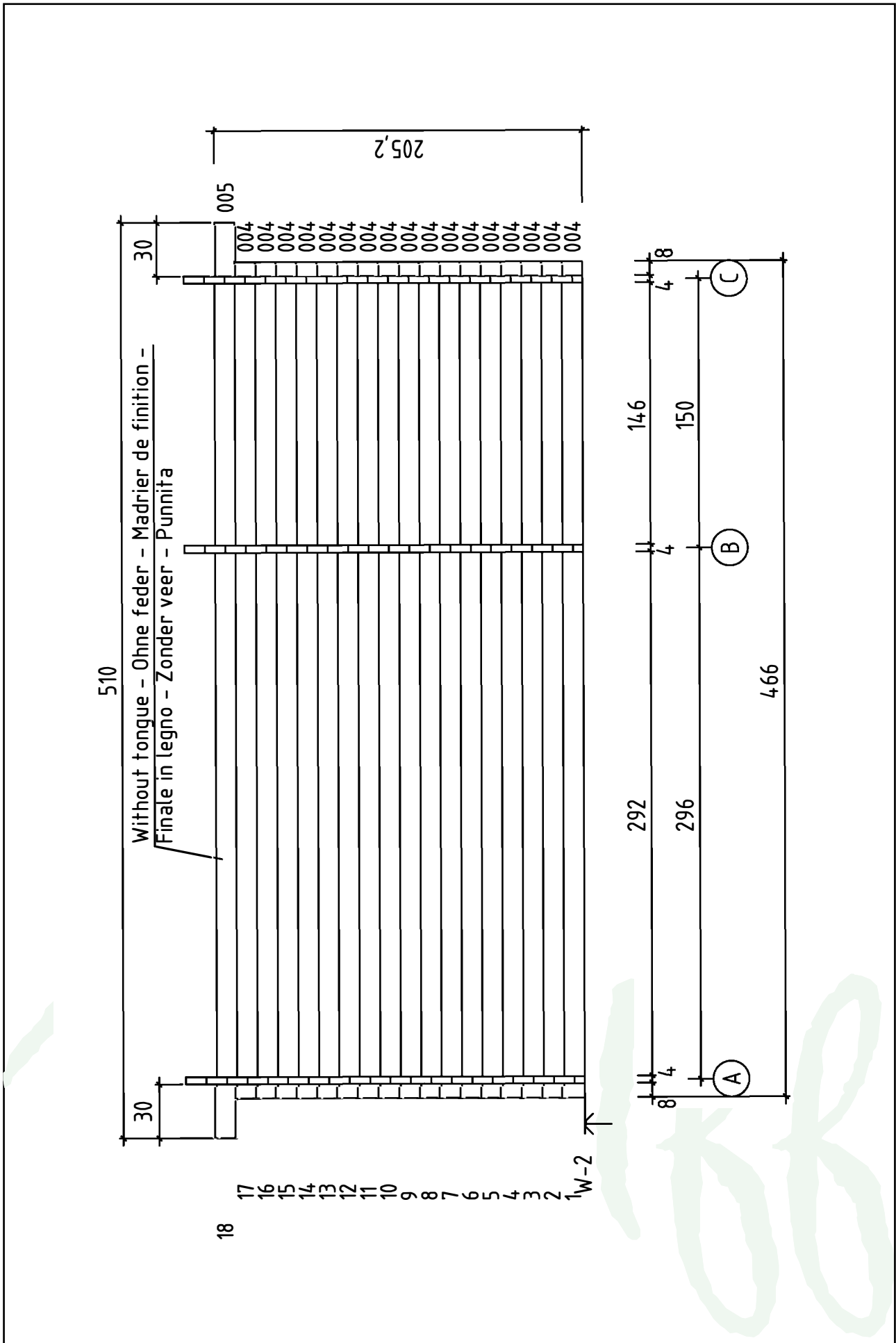

Wandplan B Nancy

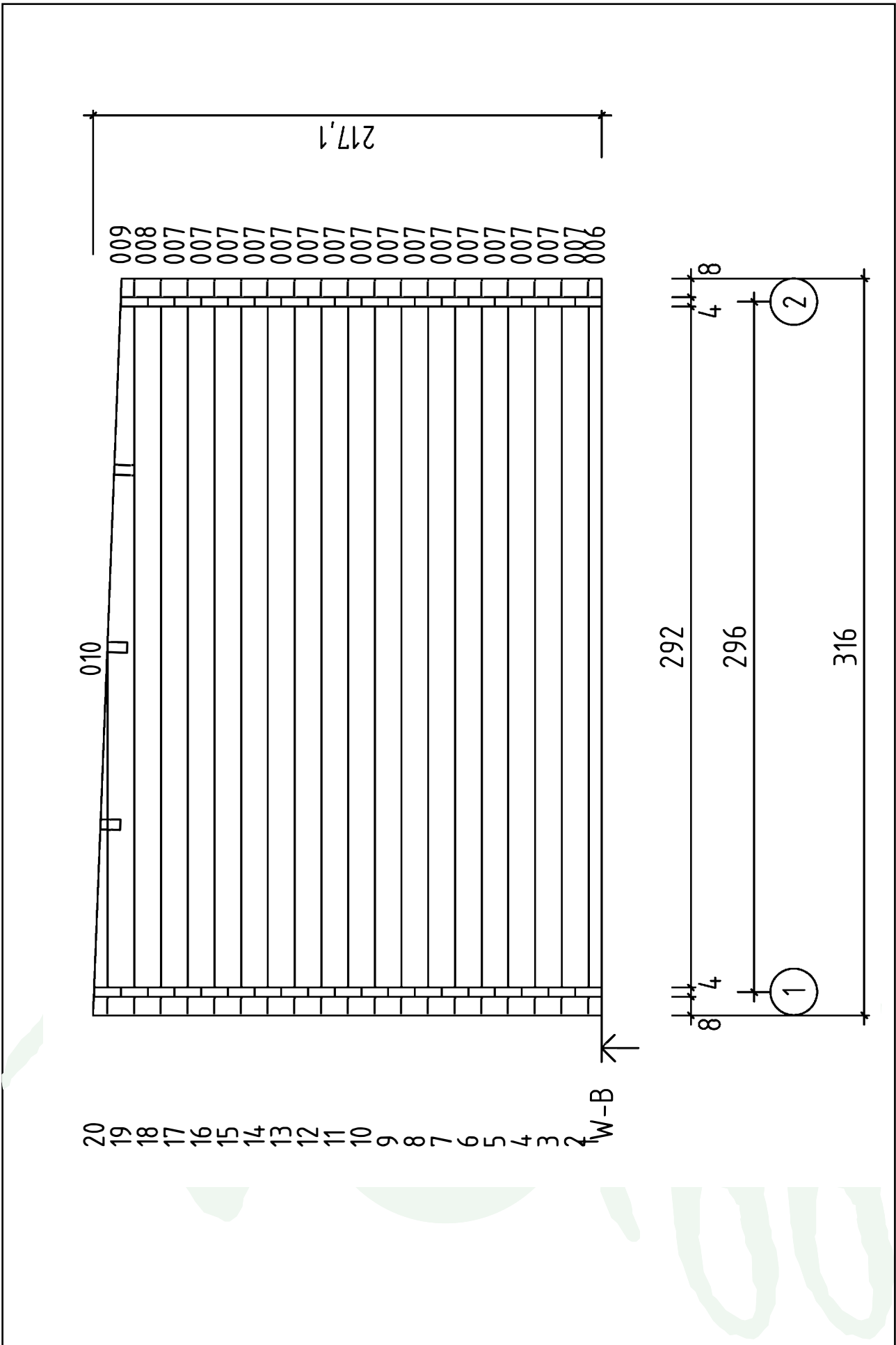

Wandplan D Nancy

