

Technische Daten: Art.-Nr.: 536060

Wandaußenmaß: 453 x 299 cm

Bohlenstärke: 40 mm



**Dieses Haus lässt sich auch spiegelverkehrt aufbauen.
Darum ist es erforderlich, die Fußbodenbretter im Eingangsbereich
laut beigefügter Zeichnung selbst zuzuschneiden.**

Kontrolliert durch:

Achtung: Alle angegebenen Maße sind ca.-Maße!

3D-Darstellung 536060

Das Haus Anna lässt sich auch spiegelverkehrt aufbauen. Darum ist es erforderlich, die Fussbodenbretter im Eingangsbereich laut beigefügter Zeichnung selbst zuzuschneiden.

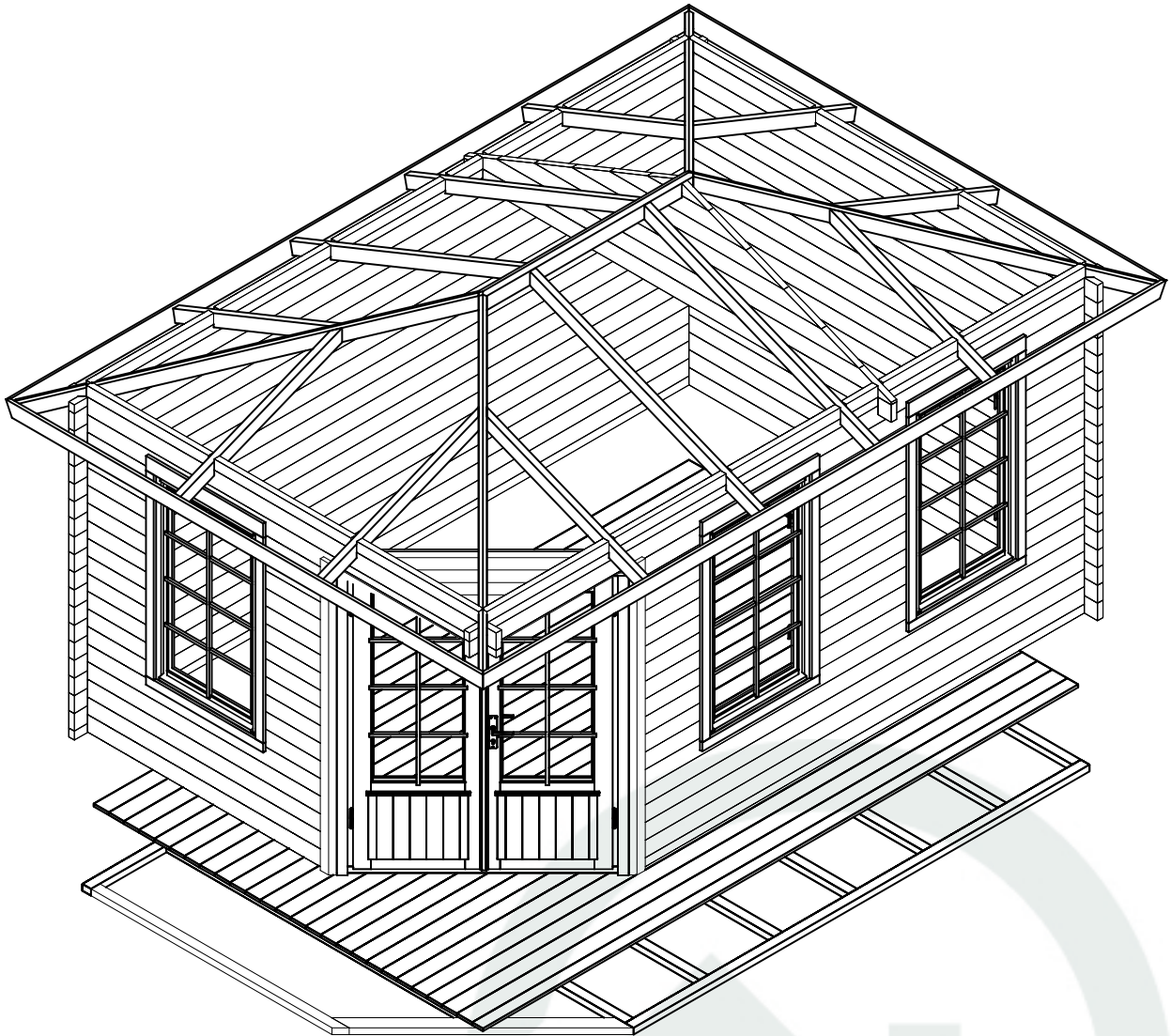

Grundriss 536060

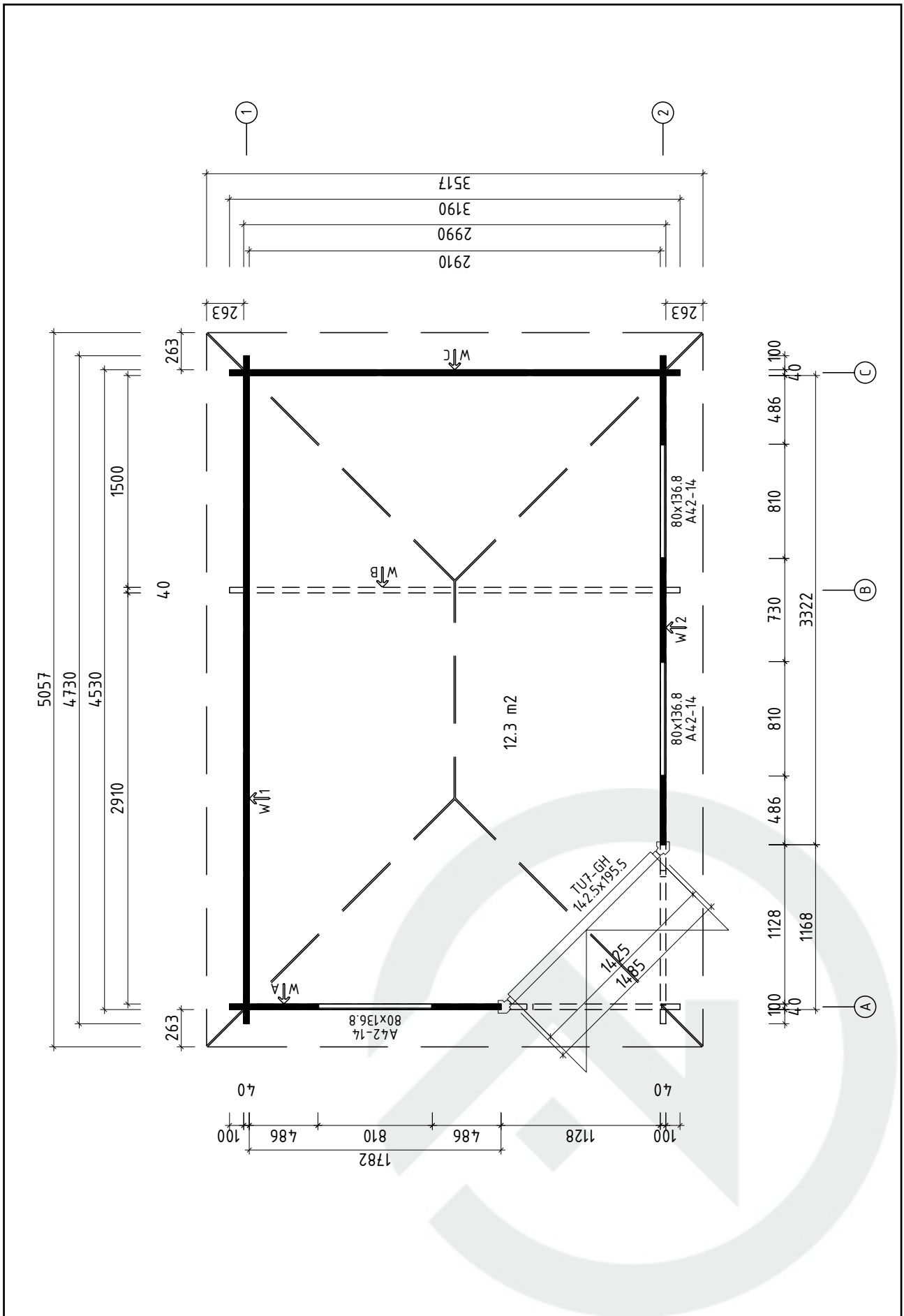

Lagerholzplan und Fundamentplan 536060

**Wir empfehlen als Fundament für Ihr Gartenhaus eine vollflächig festgegründete, gepflasterte oder betonierte Fläche.
Wahlweise ist auch ein Punkt- oder Streifenfundament möglich.**

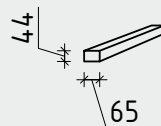
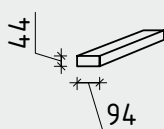
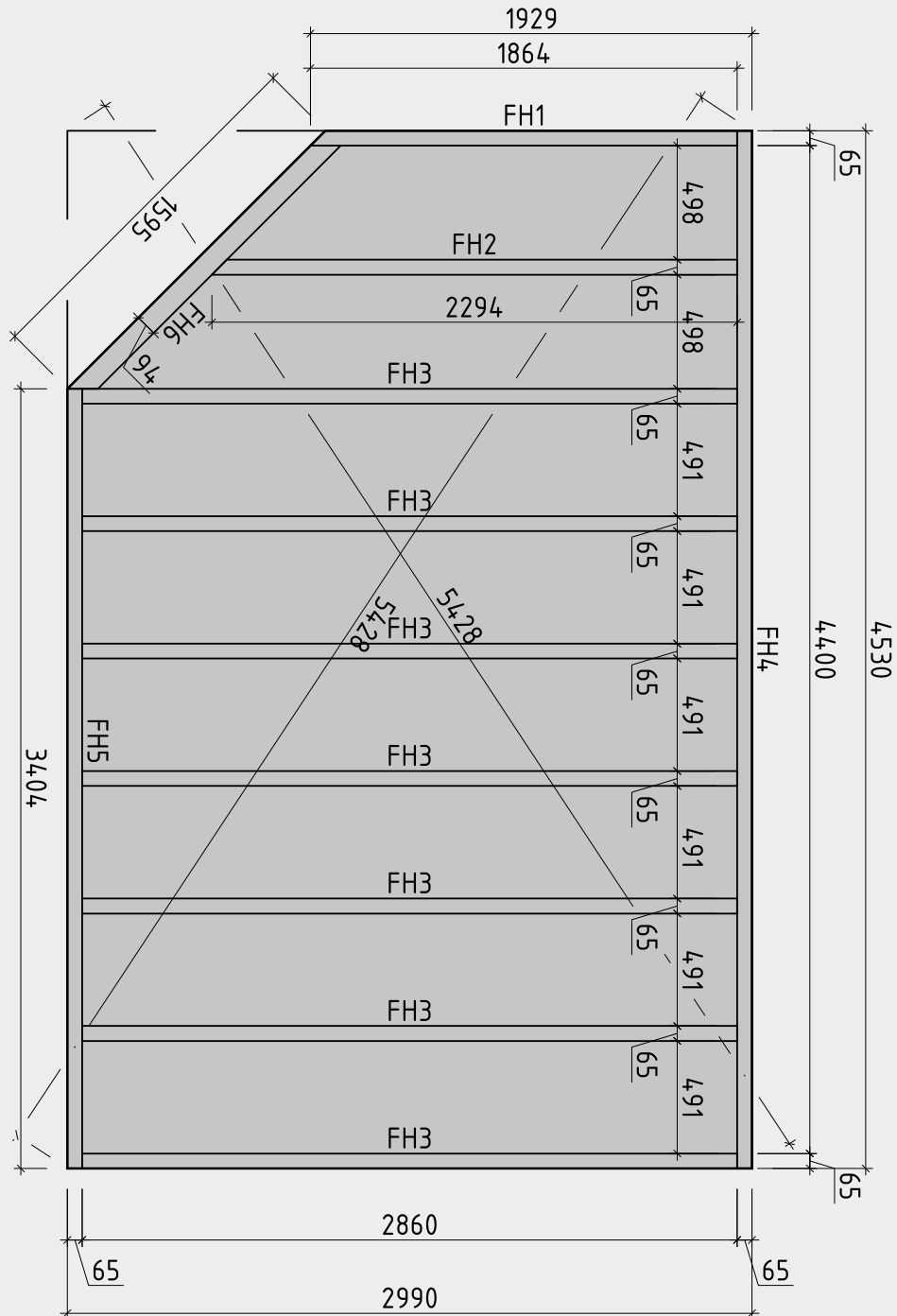

Detailansicht Fußboden 536060

Anna A1 473x319/40

Zuschneiden der
Fußbodenbretter 113x18mm

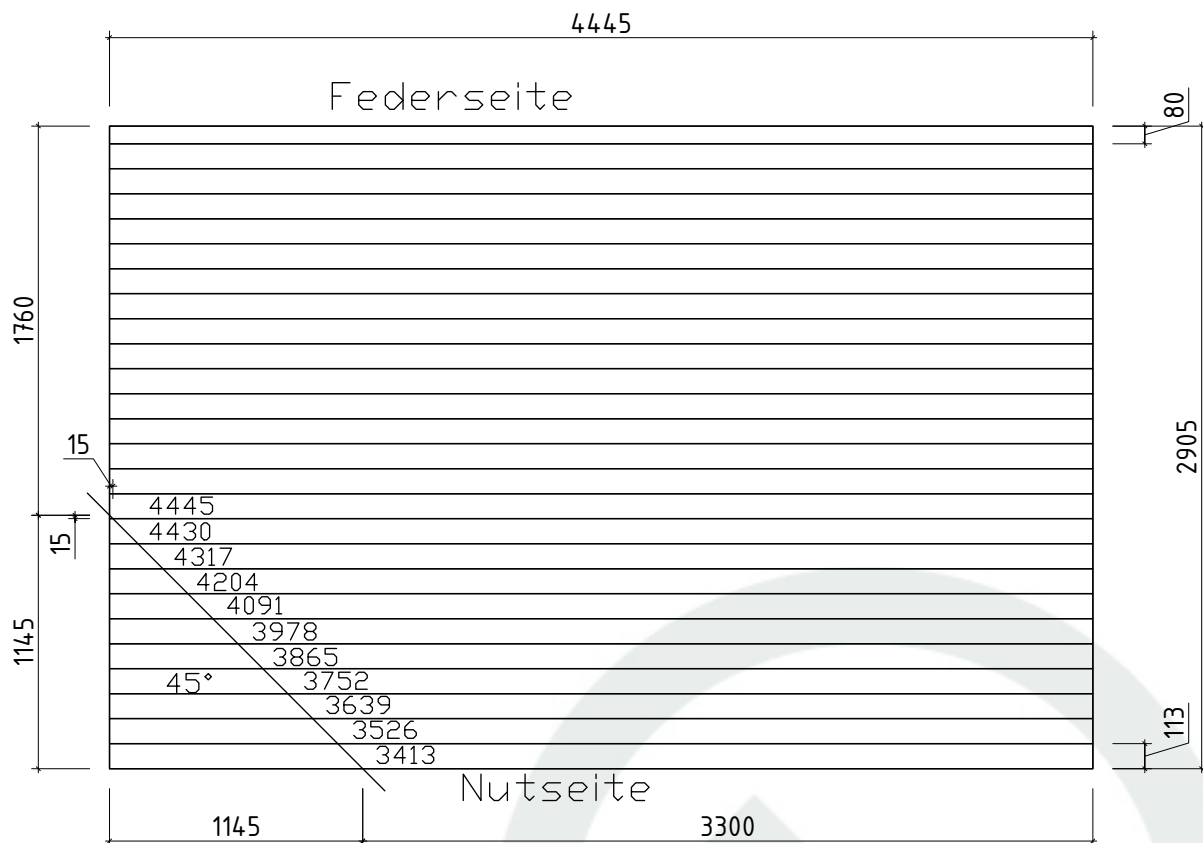















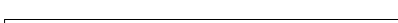

Teileliste 1

536060

Pos		Stck	Profil (mm)	Länge (mm)
001		2	40x57	4730
002		1	40x114	4730
003		1	40x114	4730
004		17	40x114	4730
005		1	40x57	4730
006		1	40x114	3462
007		4	40x114	3462
008		1	40x57	3462
009		1	40x114	3190
010		2	40x114	3190
011		19	40x114	3190
012		1	40x114	3190
013		1	40x114	2704
014		1	40x114	2142
015		5	40x114	1922
016		1	40x114	1580
017		2	40x72	1020
018		1	40x114	1017
019		✓ 4+4	40x72	910
020		2	40x72	831
021		2	40x72	810
022		10	40x114	730
023		2	40x114	730
024		24	40x114	626
025		2	40x72	555

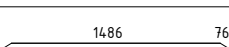



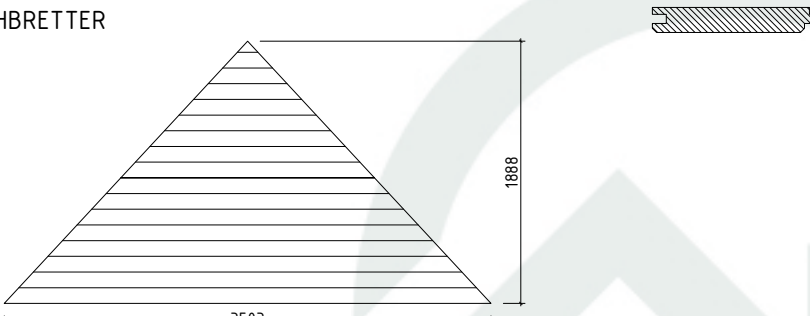
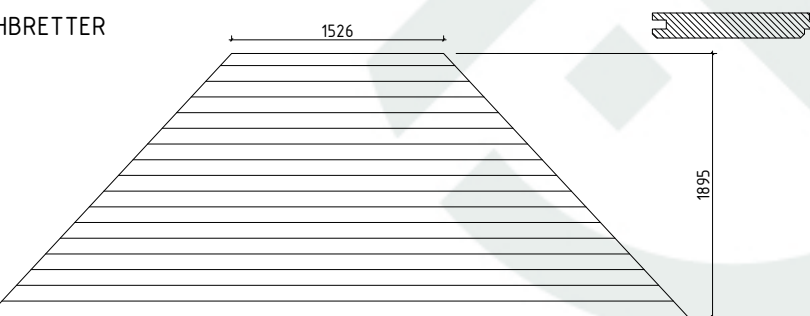





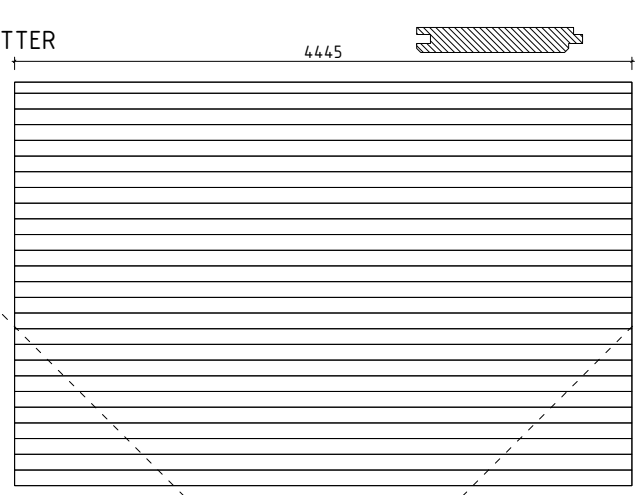

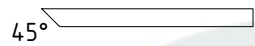

Teileliste 2

536060

Pos		Stck	Profil (mm)	Länge (mm)
026		24	40x114	456
027	 	2	40x72	236
028		1	40x80	197
029		1	40x80	197
FH6	 45°	1	94x44	1595
FH4		1	65x44	4530
FH5		1	65x44	3404
FH3		7	65x44	2860
FH2	 45°	1	65x44	2294
FH1	 45°	1	65x44	1864
LE1		4	15x40	1358
DB1		1	62x105	1602
PF3		4	44x94	2564
PF1		4	44x85	1879
PF2		4+4	44x85	1329
	<p>DACHBRETTER</p> 	2	113x18	
	<p>DACHBRETTER</p> 	2	113x18	

Teileliste 3

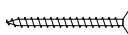
536060

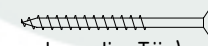
Pos		Stck	Profil (mm)	Länge (mm)
	Diese Haus lässt sich auch spiegelverkehrt aufbauen. Darum ist es erforderlich, die Fussbodenbretter im Eingangsbereich laut beigefügter Zeichnung selbst zuzuschneiden.			
	FUSSBODENBRETTER 	✓	26+1 113x18	4445
	FUSSBODENLEISTE	✓	18x40	15,0 lfm
T1-1	TRAUFENBRETTER 120X18	✓	120x18	3615
T1-2	TRAUFENBRETTER 120X18	✓	120x18	5155
P9L-1	ECKTÜR- linke Türpfoste 90		1	90x90 2015
P9R-1	ECKTÜR- rechte Türpfoste 90		1	90x90 2015
DzT 40-1	ECKTÜR- Deckbrett zum Tür 40		1	18x40 1585
VK-1	ECKTÜR- Verkleidungsleisten für Vordachelement		✓	2 58x12 1110
VE1	ECKTÜR- Vordachelement 1435x745		1	
SH	Schlaghölzer		3	
SM-1	Sturmleisten		4	40x18 2050
SMS	Schlossschrauben M8x70 Mutter U-Scheibe		12	
ML1	Metallstange		2	D10 870
NG3	DACHPAPPNÄGEL 2.0x18		430	
NG1	NÄGEL 2.5x50 Dachbretter Fussbodenbretter		1132	
SR03	SCHRAUBEN 3.5x45 Traufenbretter, Deckbrett, Türleisten Verkleidungsleiste, Vordachelement, LE1		124	
SR11	SCHRAUBEN 5.0x100 Fundamenthölzer, Pfetten 85x44 Wandbalken (Pos 019,020,021,025,027,012,001,017), Pfetten 94x44		105	
SR10	SCHRAUBEN 5.0x70 Pfetten 85x44 pos 008 und 015 (1. Bohlenreihe neben die Tür)		12	

Wandplan A 536060

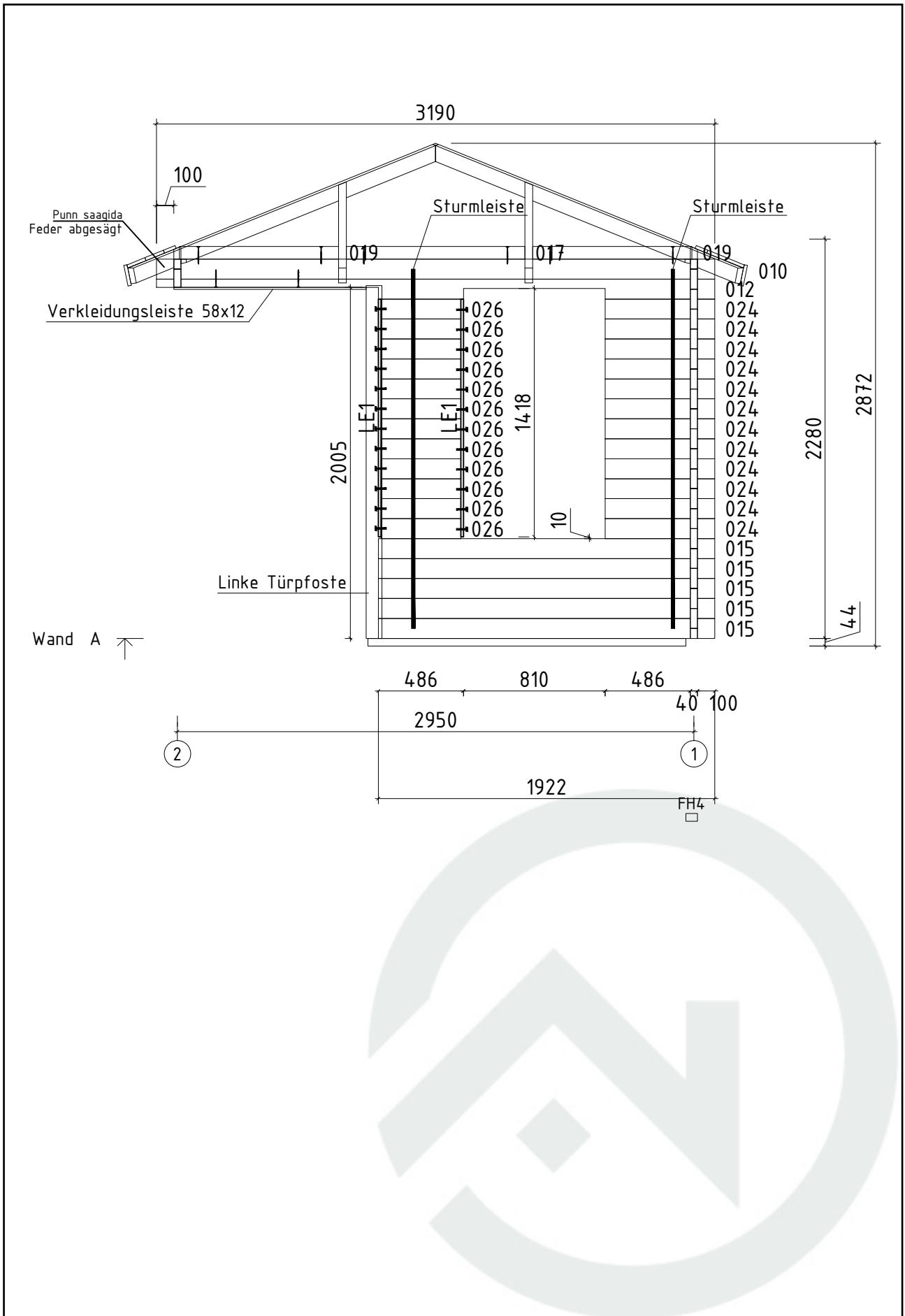

Wandplan B 536060

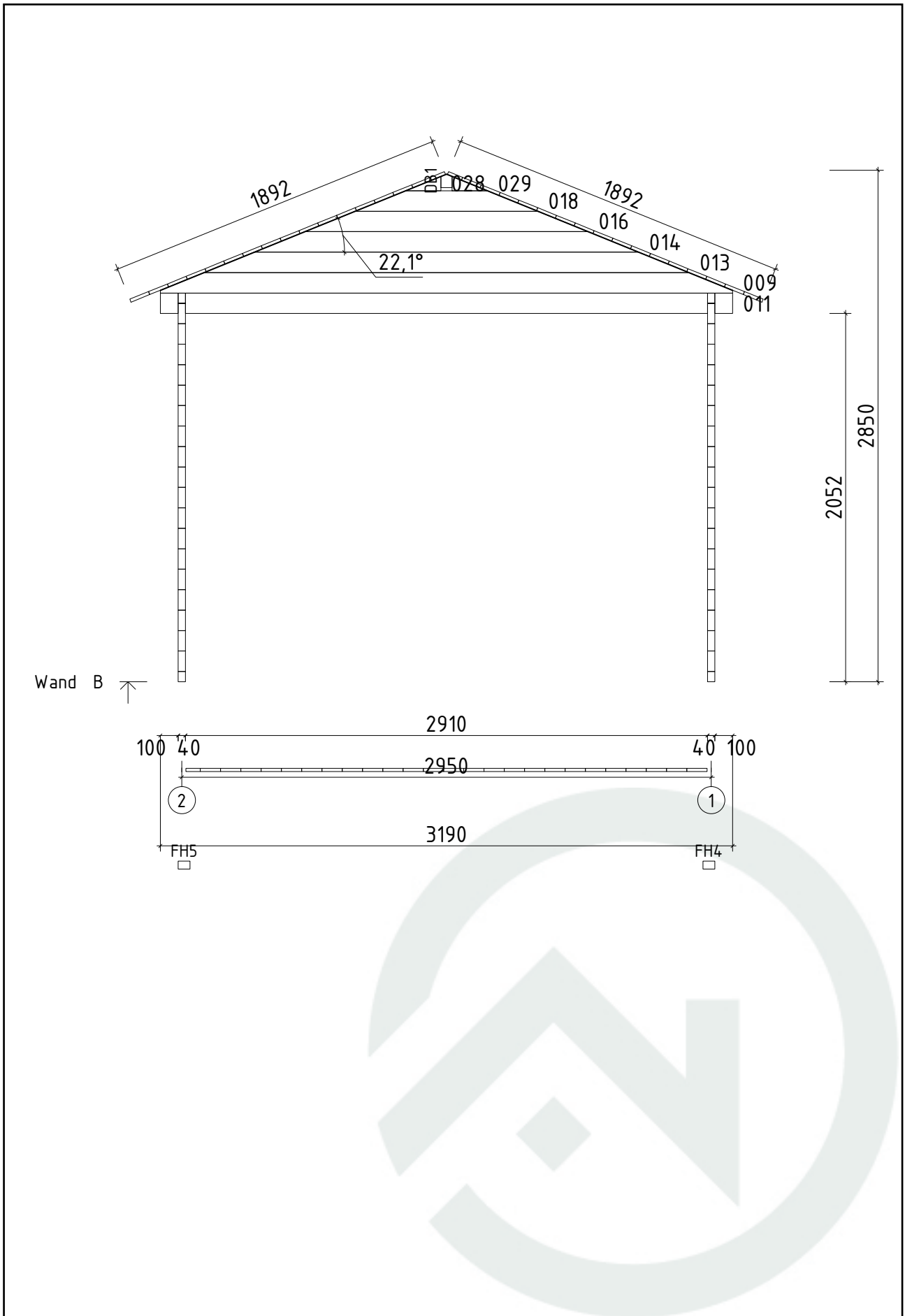

Wandplan C

536060

