

Technische Daten: Art.-Nr.: 536050

Wandaußenmaß: 453 x 299 cm

Bohlenstärke: 40 mm



**Dieses Haus lässt sich auch spiegelverkehrt aufbauen.
Darum ist es erforderlich, die Fußbodenbretter im Eingangsbereich
laut beigefügter Zeichnung selbst zuzuschneiden.**

Kontrolliert durch:

Achtung: Alle angegebenen Maße sind ca.-Maße!

3D-Darstellung und Grundriss 536050

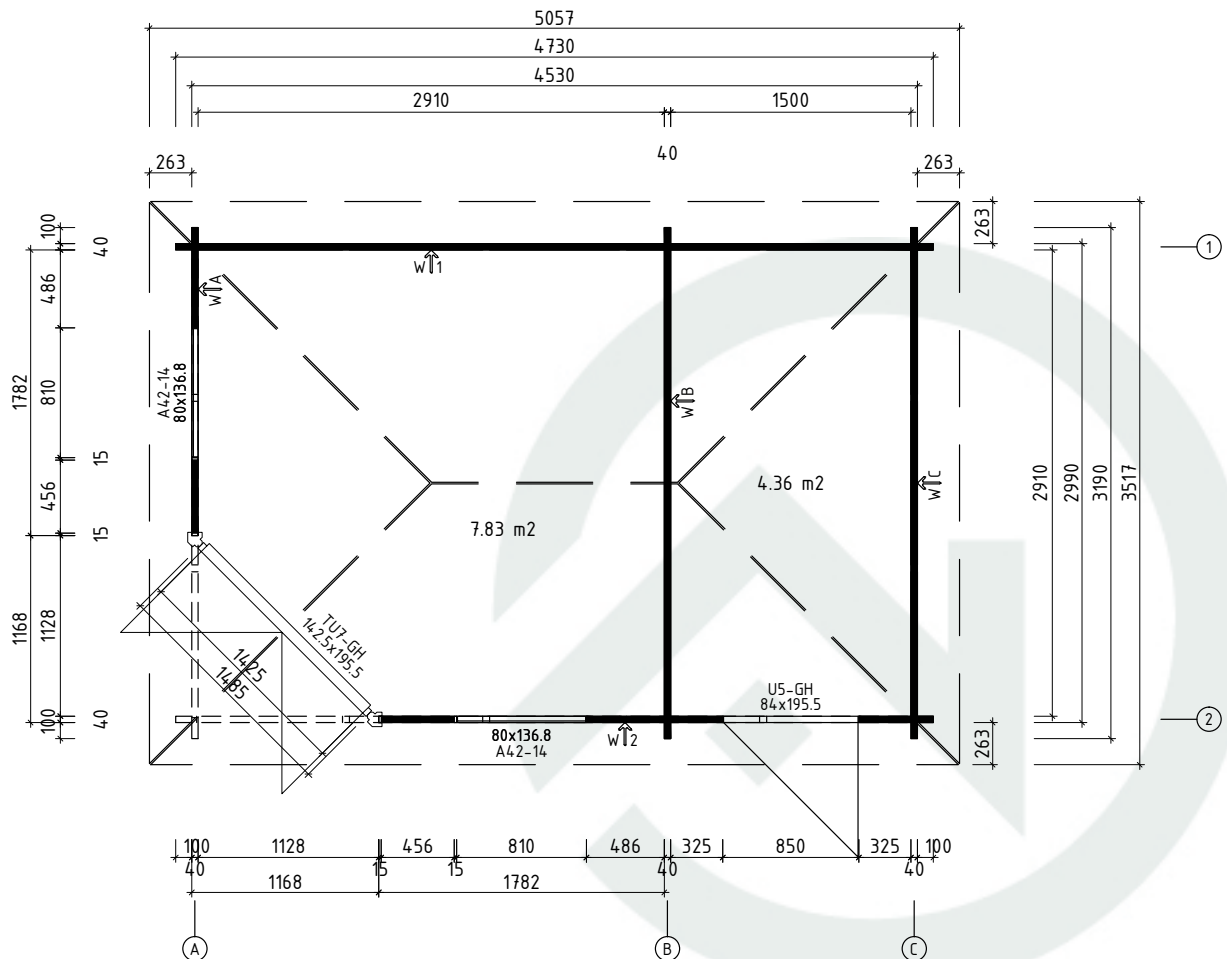
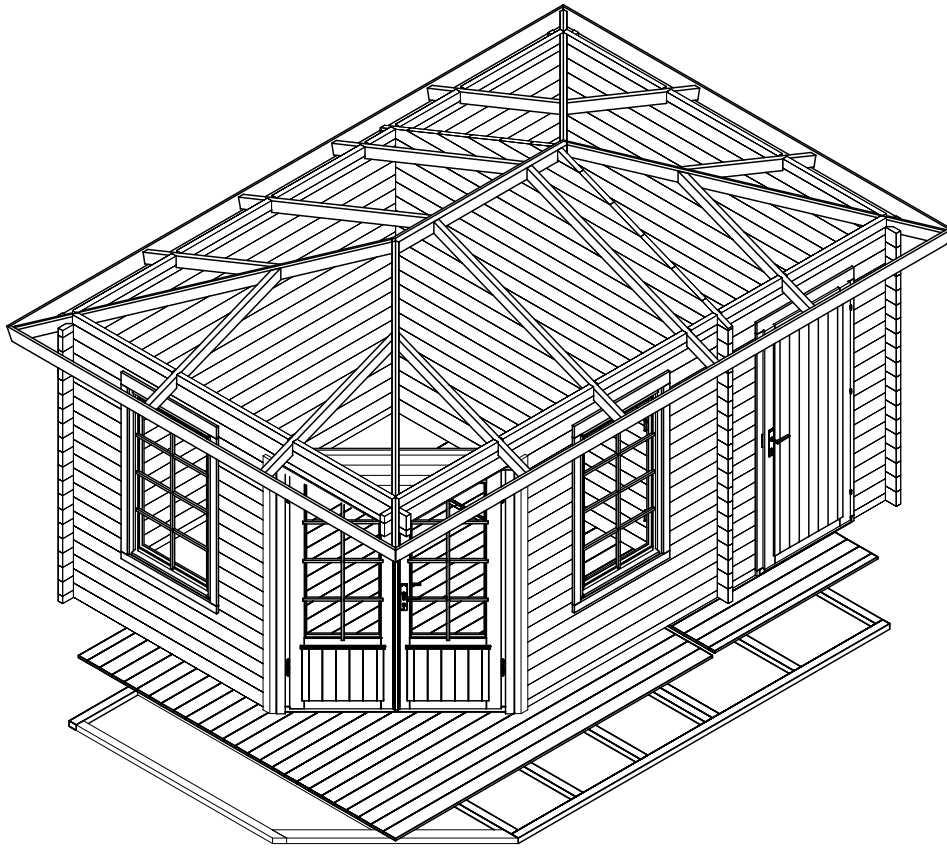

Lagerholzplan und Fundamentplan 536050

Wir empfehlen als Fundament für Ihr Gartenhaus eine vollflächig festgegründete, gepflasterte oder betonierte Fläche.
Wahlweise ist auch ein Punkt- oder Streifenfundament möglich.

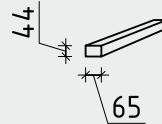
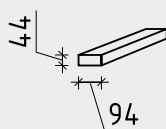
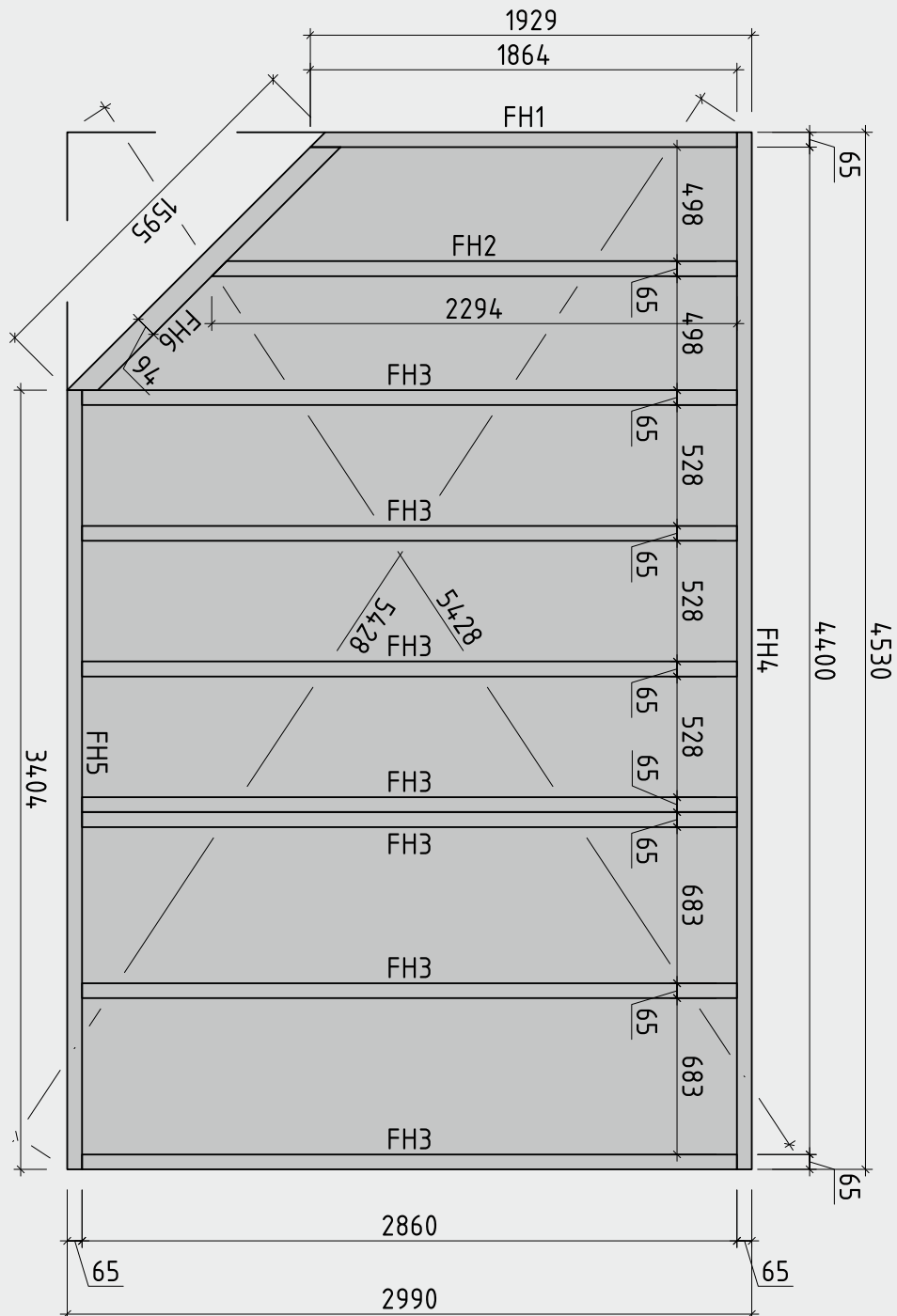

Dachplan 536050

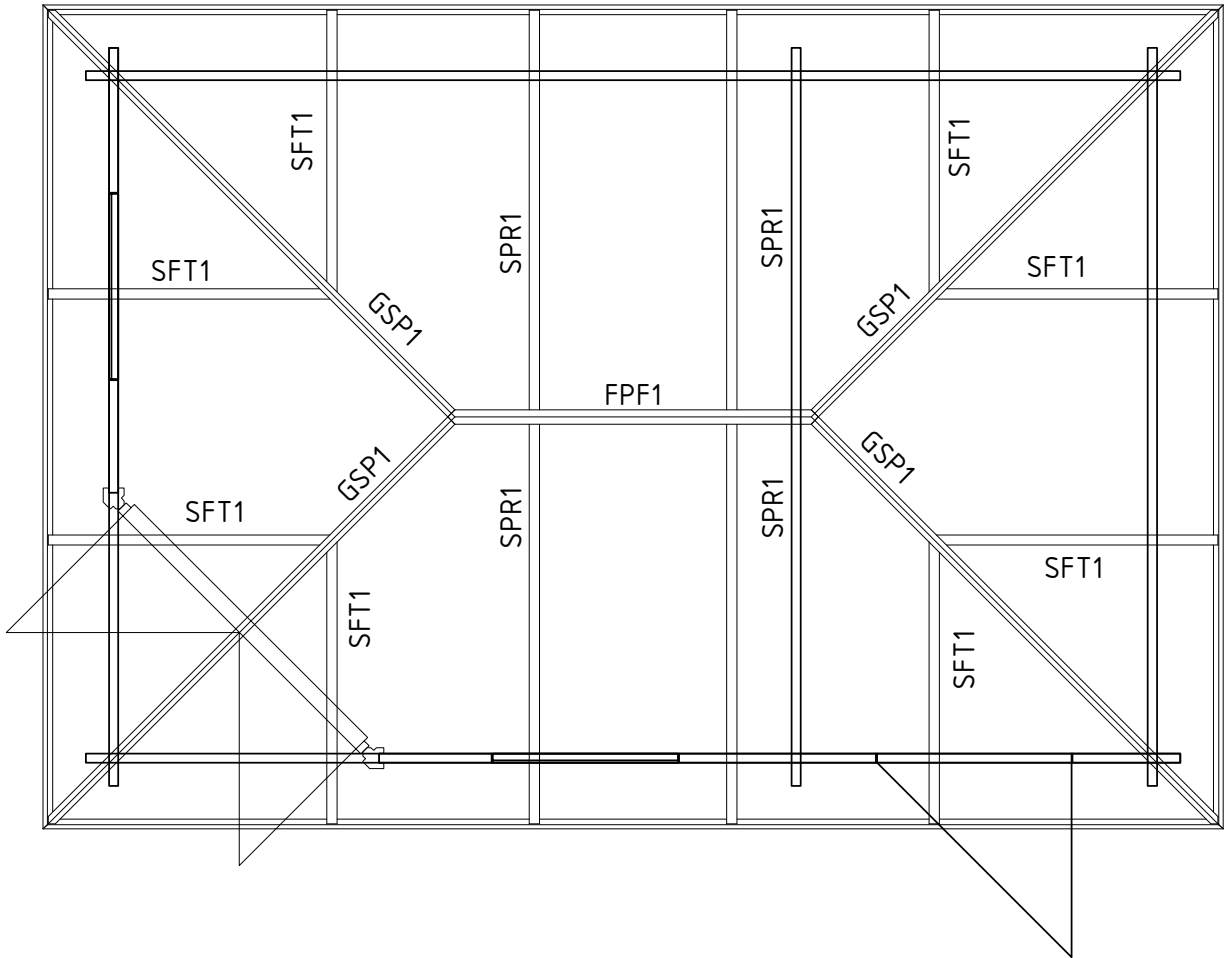











Teileliste 1

536050

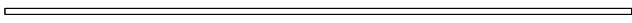
Pos		Stck	Profil (mm)	Länge (mm)
001		2	40x57	4730
002		1	40x114	4730
003		18	40x114	4730
004		1	40x57	4730
005		1	40x114	3190
006		2	40x114	3190
007		37	40x114	3190
008		1	40x114	3190
009		1	40x114	2704
010		1	40x57	2147
011		4	40x114	2147
012		1	40x114	2147
013		1	40x114	2142
014		5	40x114	1922
015		1	40x114	1580
016		2	40x72	1020
017		1	40x114	1017
018		✓ 4+4	40x72	910
019		12	40x114	851
020		2	40x72	831
021		2	40x72	810
022		12	40x114	626
023		2	40x72	555
024		1	40x57	465
025		17	40x114	465

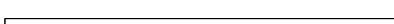
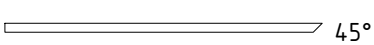
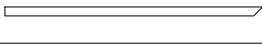
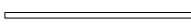
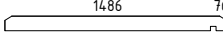

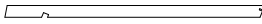
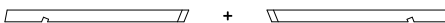
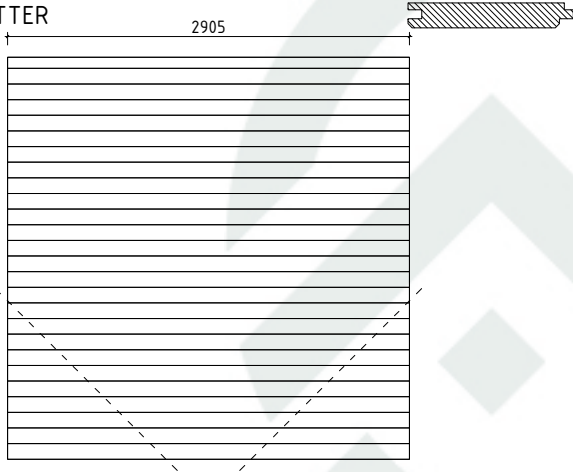







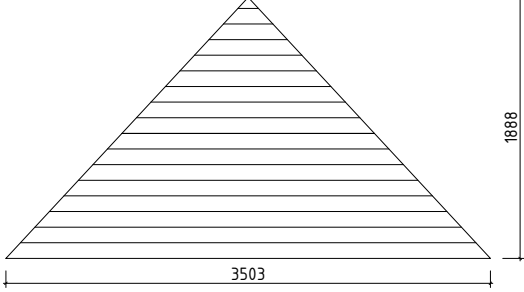
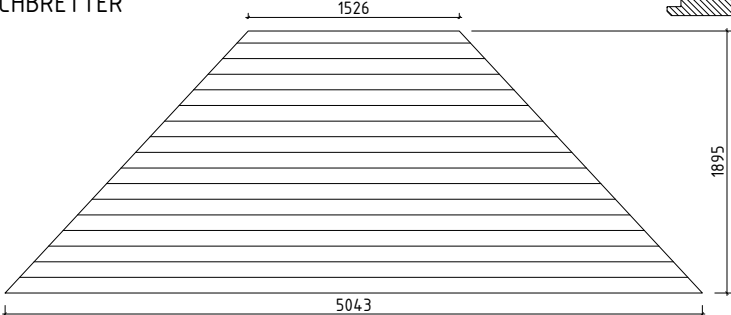
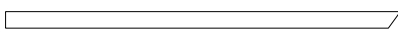
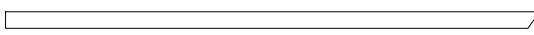

Teileliste 2

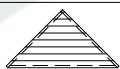
536050

Pos		Stck	Profil (mm)	Länge (mm)
026		24	40x114	456
027		2	40x72	236
028		1	40x80	197
029		1	40x80	197
FH6	FUNDAMENTHÖLZER (imprägniert) 	1	94x44	1595
FH4	FUNDAMENTHÖLZER (imprägniert) 	1	65x44	4530
FH5	FUNDAMENTHÖLZER (imprägniert) 	1	65x44	3404
FH3	FUNDAMENTHÖLZER (imprägniert) 	7	65x44	2860
FH2	FUNDAMENTHÖLZER (imprägniert) 	1	65x44	2294
FH1	FUNDAMENTHÖLZER (imprägniert) 	1	65x44	1864
LE1	LEISTE 	4	15x40	1358
FPF1	FIRSTPFETTEN 	1	62x105	1602
GSP1	GRATSPARREN 	4	44x94	2564
SPR1	SPARREN 	4	44x85	1879
SFT1	SCHIFTER 	4+4	44x85	1329
<p>Diese Haus lässt sich auch spiegelverkehrt aufbauen. Darum ist es erforderlich, die Fussbodenbretter im Eingangsbereich laut beigefügter Zeichnung selbst zuzuschneiden.</p>				
	<p>FUSSBODENBRETTER</p> 	26+1	113x18	2905
	<p>FUSSBODENBRETTER</p> 	26	113x18	1495
	<p>FUSSBODENLEISTE</p> 		18x40	21,0 lfm

Teileliste 3

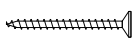
536050

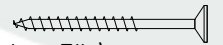
Pos		Stck	Profil (mm)	Länge (mm)
	DACHBRETTER 	2	113x18	
	DACHBRETTER 	2	113x18	
T1-1	TRAUFBRETT 120X18  ✓	2	120x18	3615
T1-2	TRAUFBRETT 120X18  ✓	2	120x18	5155
P9L-1	ECKTÜR- linker Türpfosten 90 	1	90x90	2015
P9R-1	ECKTÜR- rechter Türpfosten 90 	1	90x90	2015
DzT 40-1	ECKTÜR- Deckbrett für Tür 40 	1	18x40	1585
VK-1	ECKTÜR- Verkleidungsleisten für Vordachelement  ✓	2	58x12	1110
VE1	ECKTÜR- Vordachelement 1435x745 	1		
SH	Schlaghölzer 	3		
SM-1	Sturmleisten 	4	40x18	2050
SMS	Schlossschrauben M8x70 Mutter U-Scheibe 	12		
NG3	DACHPAPPNÄGEL 2.0x18 	430		
NG1	NÄGEL 2.5x50 Dachbretter Fussbodenbretter 	1142		
SR03	SCHRAUBEN 3.5x45 Traufbretter, Deckbrett Verkleidungsleiste, Vordachelement, LE1 Türleisten 	124		
SR11	SCHRAUBEN 5.0x100 Fundamenthölzer, Pfetten 85x44 Wandbalken (Pos 016,018,020,021,023,028,001,008), Pfetten 94x44 	105		
SR10	SCHRAUBEN 5.0x70 Pfetten 85x44 pos 010 und 014 (1. Bohlenreihe neben Tür) 	12		

Teileliste 4

536050

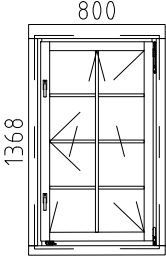
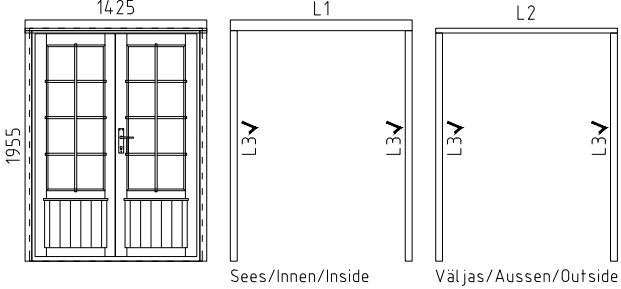
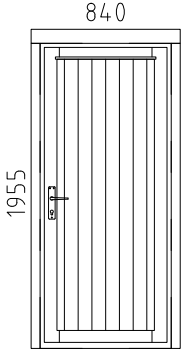
Pos		Stck	Profil (mm)	Länge (mm)
	Haube + Kugeln 	1+2		
	FENSTER 800x1368  A42-14 DIN 1xrechts+1xlinks	2	A42-14	
	TÜR 1425x1955  TU7-GH L1 18x90 L=154.0mm 1x L2 18x40 L=154.0mm 1x L3 18x58 L=1955mm 4x ✓ DIN rechts Sees/Innen/Inside Vätjas/Aussen/Outside	1	TU7-GH	
	TÜR 840x1955  U5-GH DIN rechts	1	U5-GH	
	✓ - bitte selber anpassen (falls nötig!)			

Wandplan 1 und 2 536050

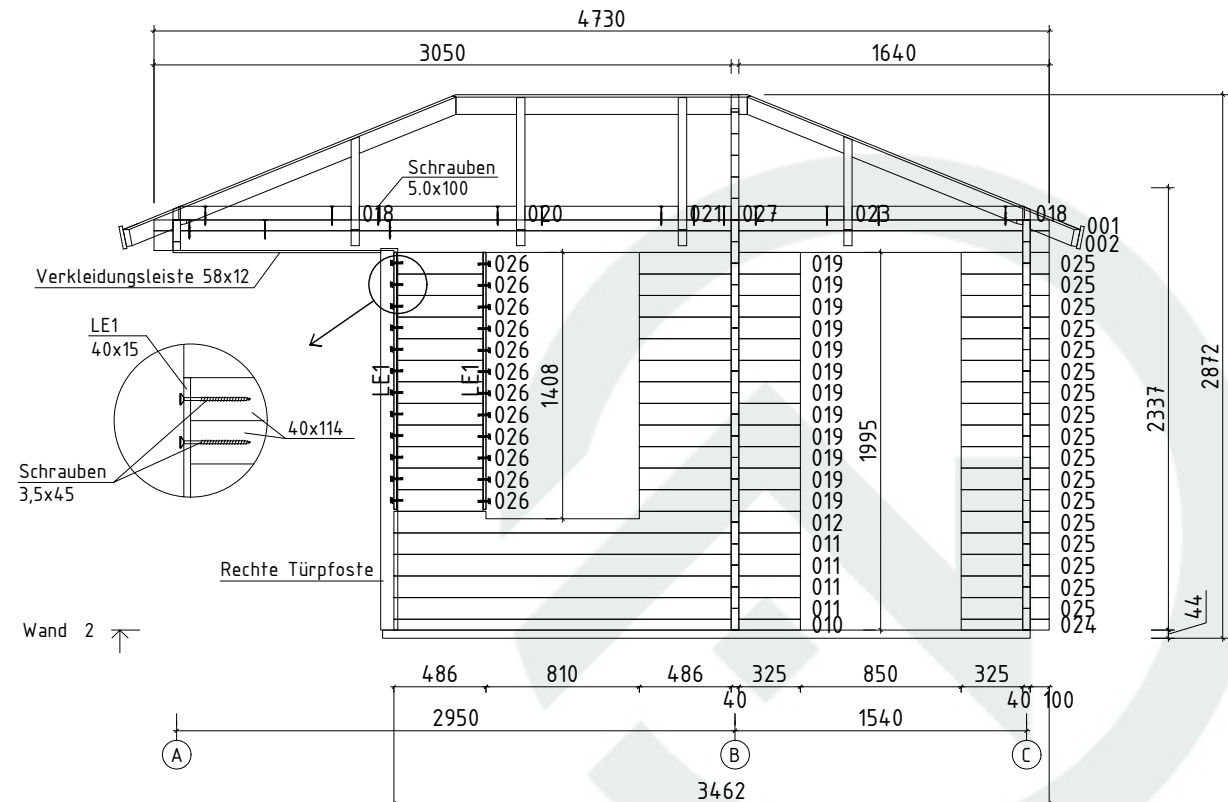
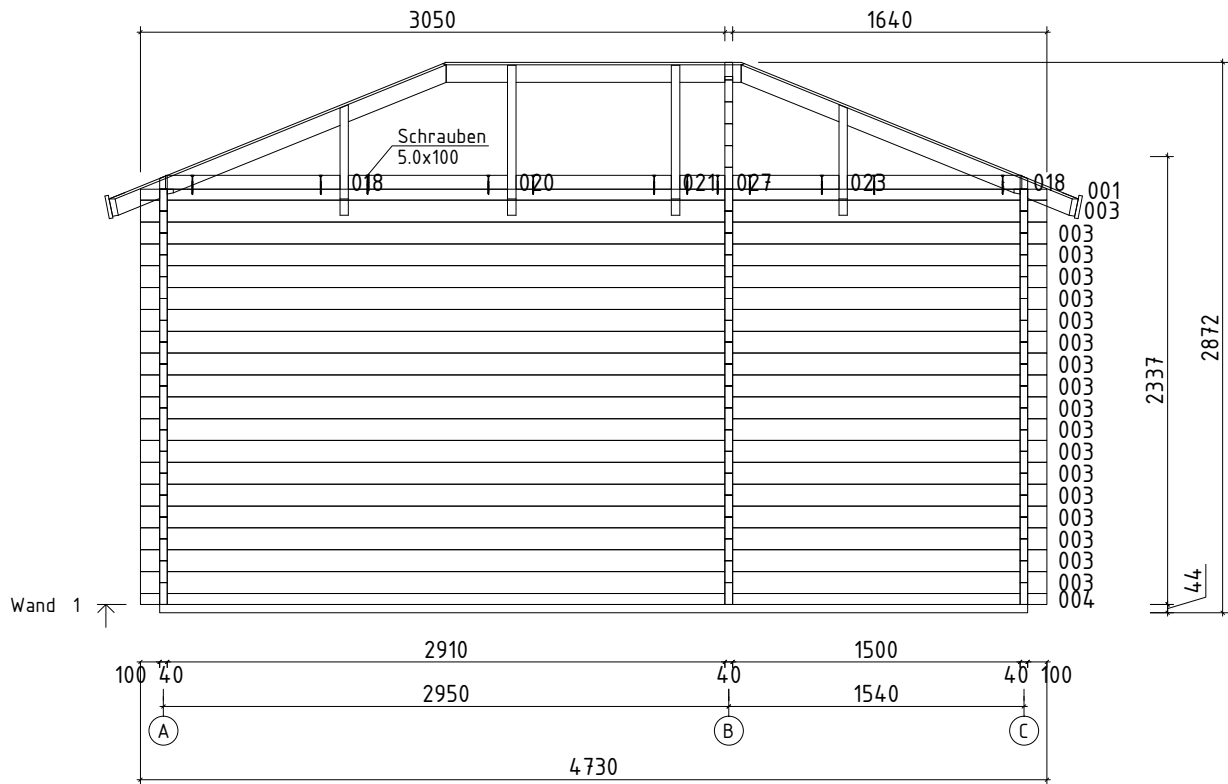

Wandplan A 536050

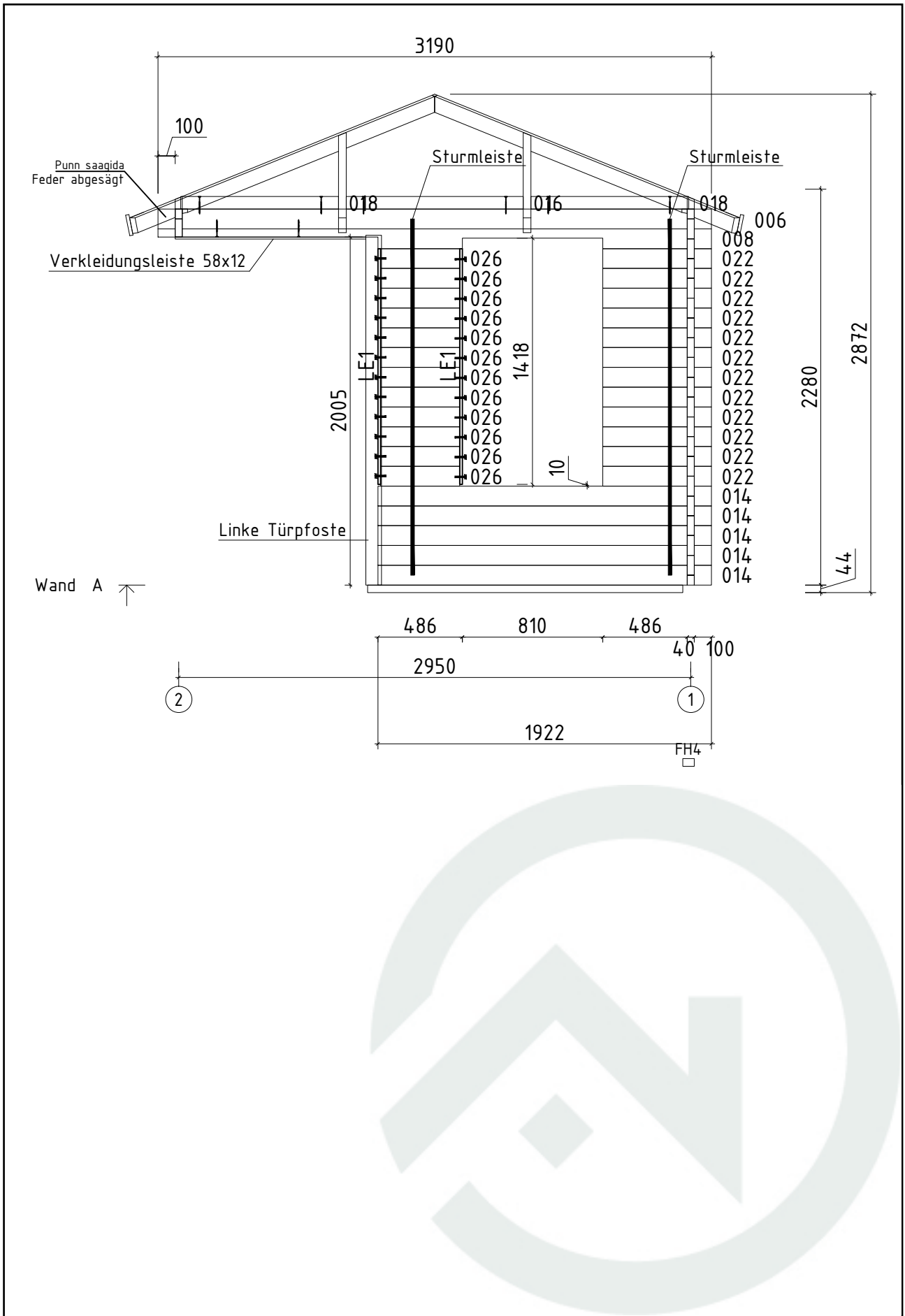

Zuschnitt Fußbodenbretter 536050

Anna A2 473x319/40

Zuschneiden der
Fußbodenbretter 113x18mm

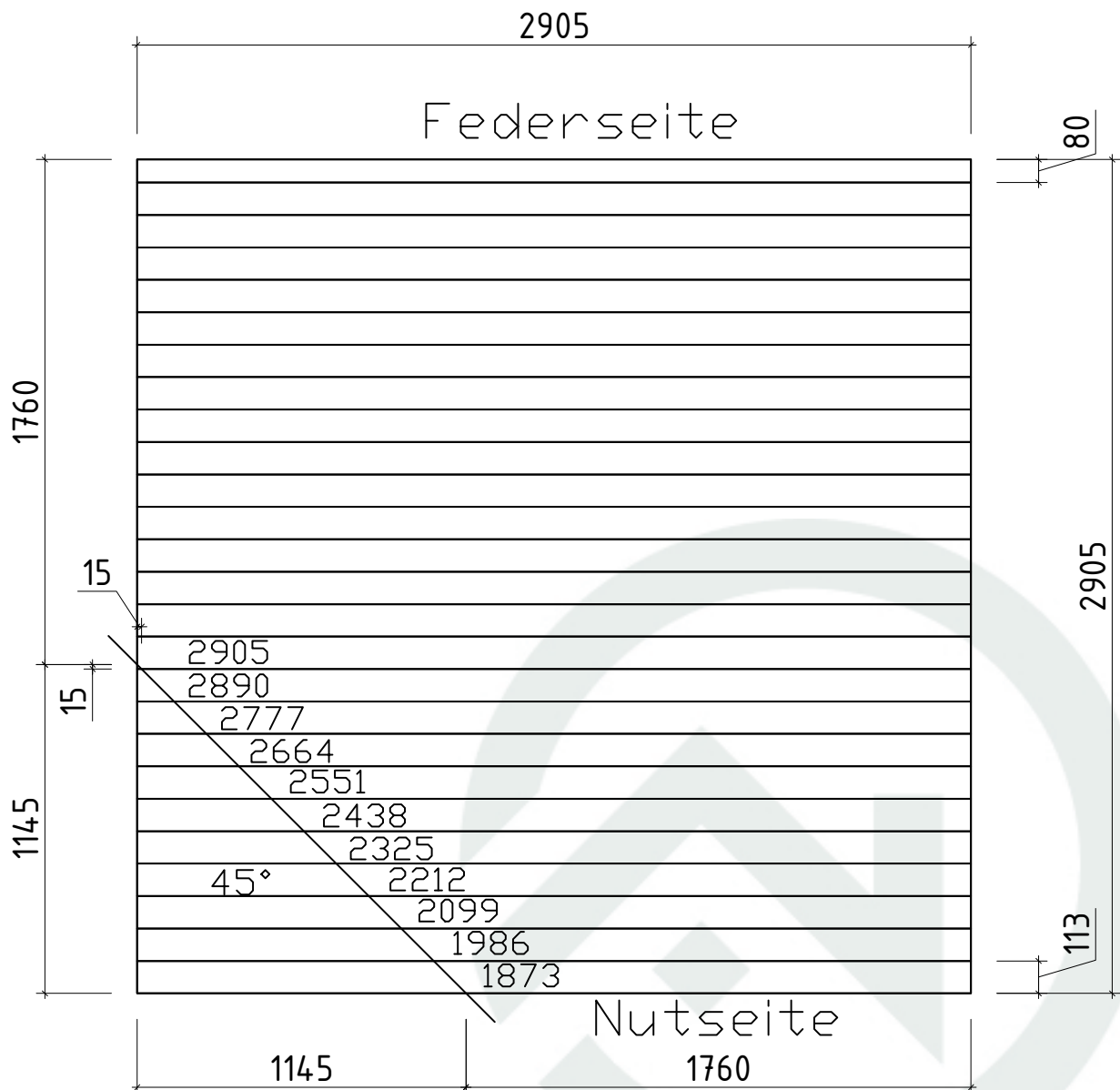

Schnitt Vordachelement 536050

Step 1: Dachelement an den Wänden verschrauben.
Step 1: Screw canopy element to the wall.

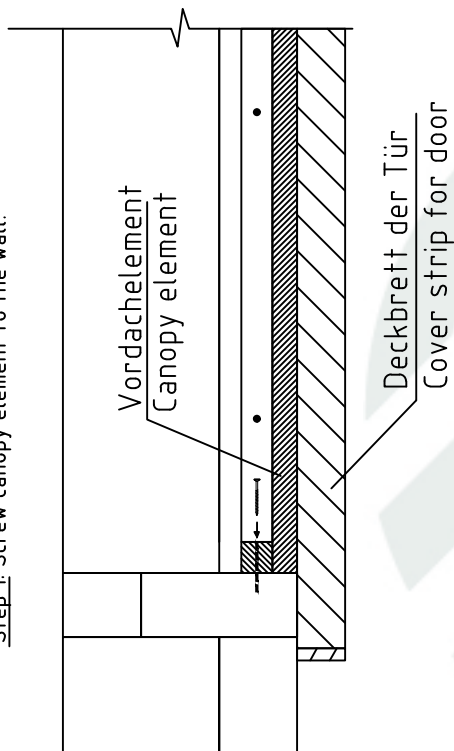

Step 2: Das Deckbrett muss von oben (durch das VD-Element) an das Dachelement verschraubt werden.

Step 2: Fasten cover strip to the canopy element.

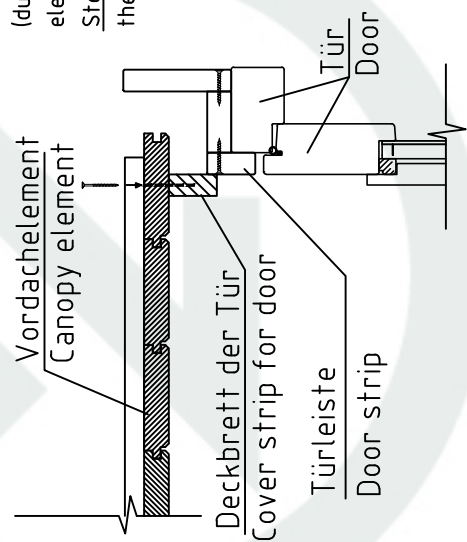

Step 3: Die Verkleidungsleisten in die richtige Länge schneiden und unter das VD-Element befestigen.

Step 3: Cut trim strips to size and fasten under the canopy element.

Deckbrett der Tür
Cover strip for door

