

Technische Daten



FARB-BEHANDLUNG
Fichte
Bernstein
Gletschergrau
Felsgrau

Artikelnummer:

534 350 ist Bestandteil von
534 215, 830 991, 830 992, 830 993, 830 994

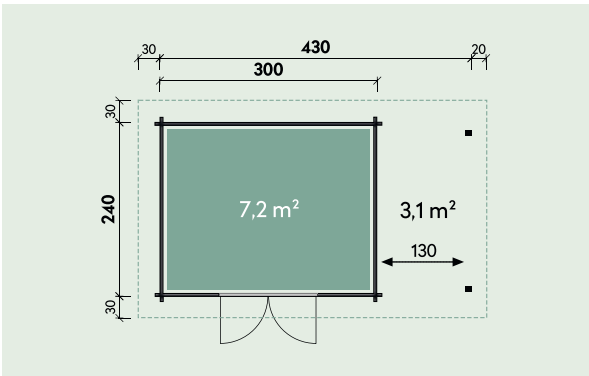

Kontrolliert durch:

Technische Daten



534 350

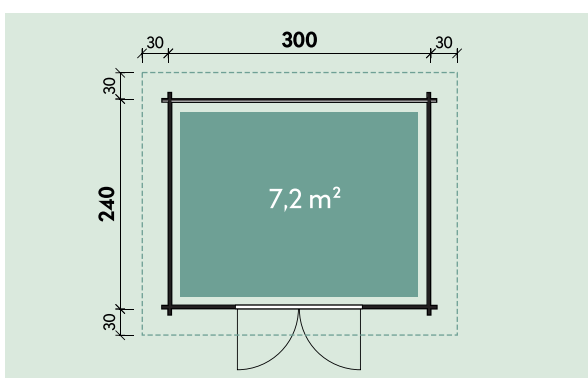

Kontrolliert durch:

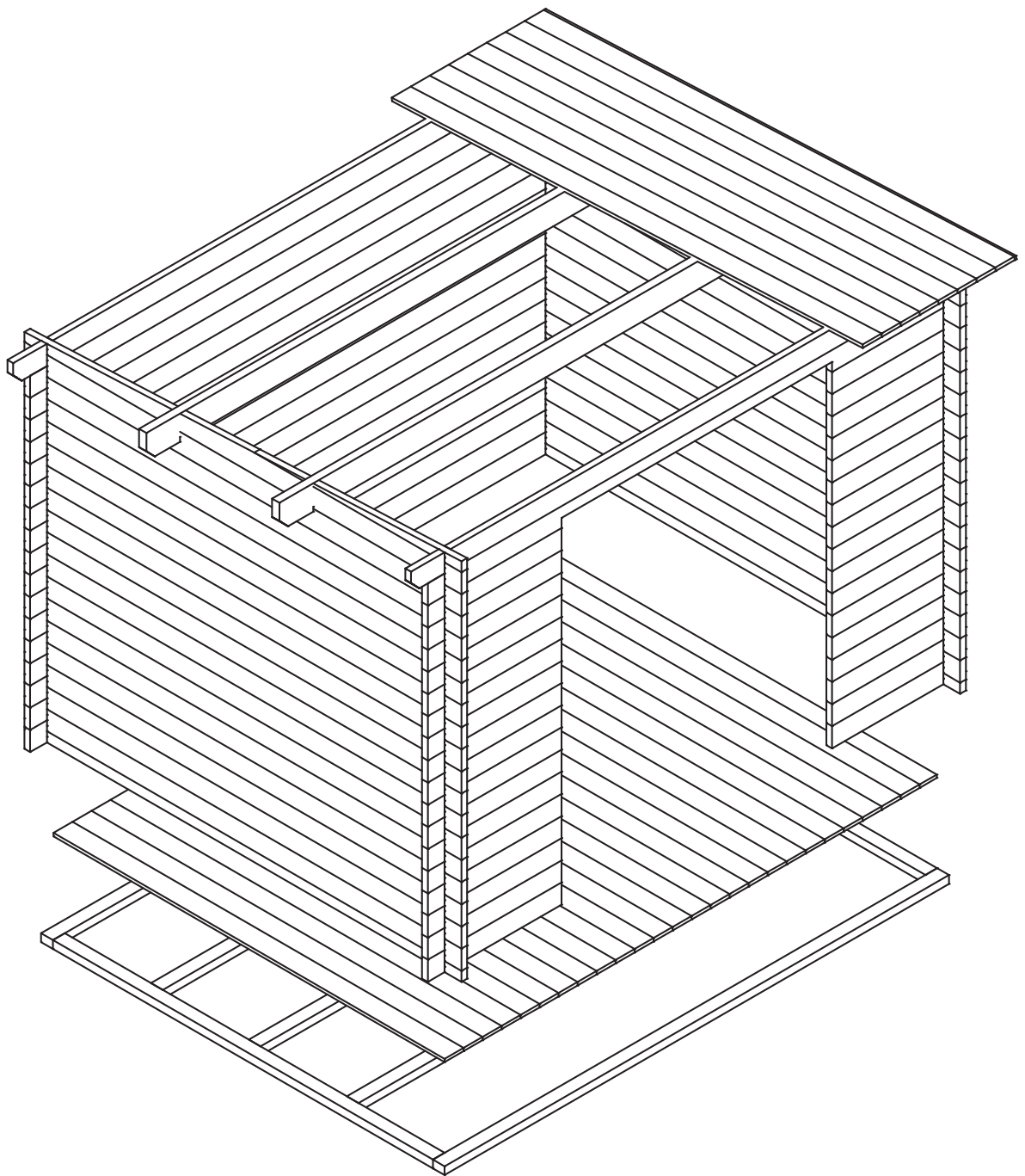

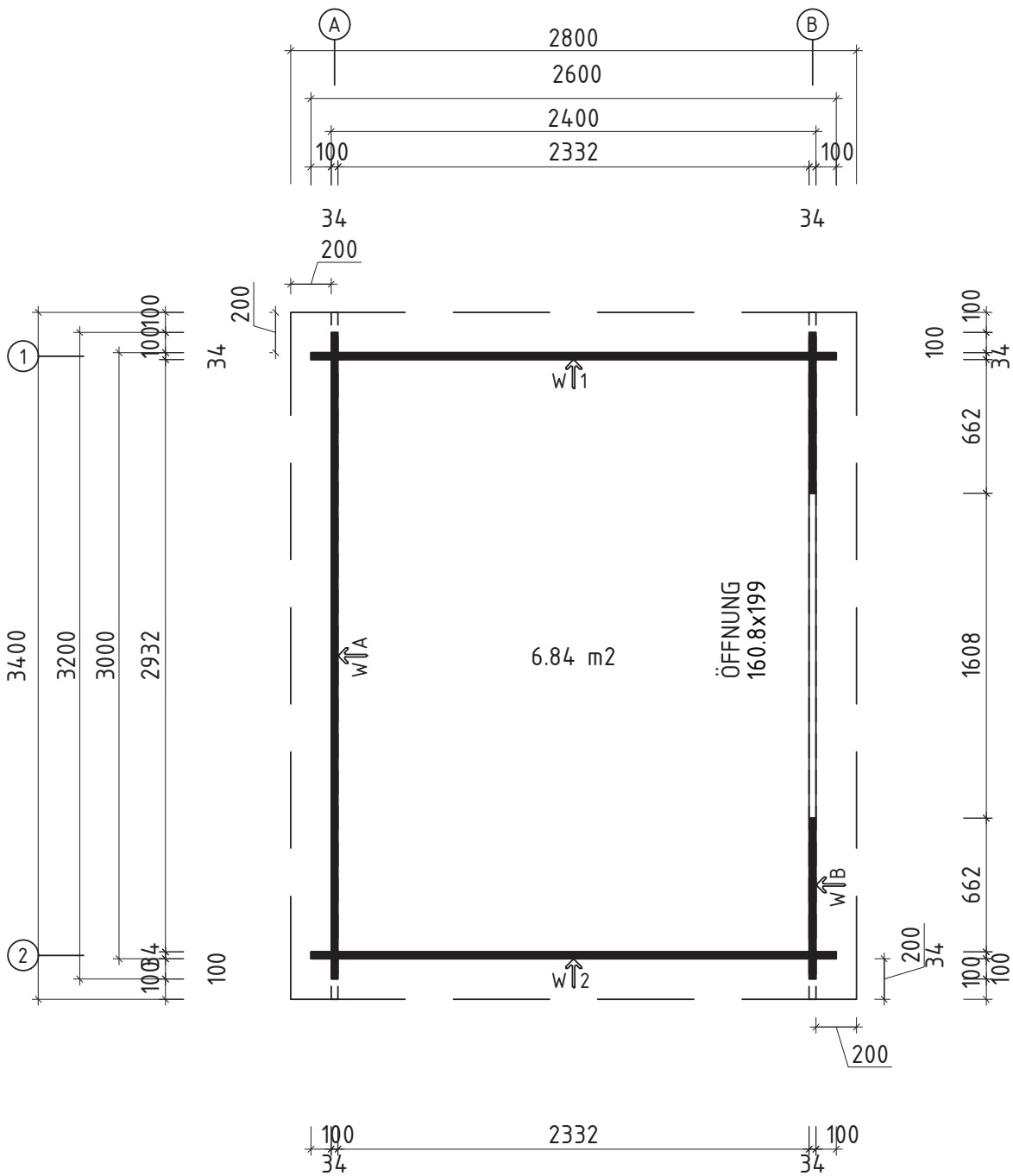

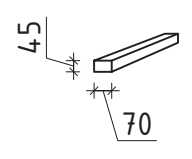
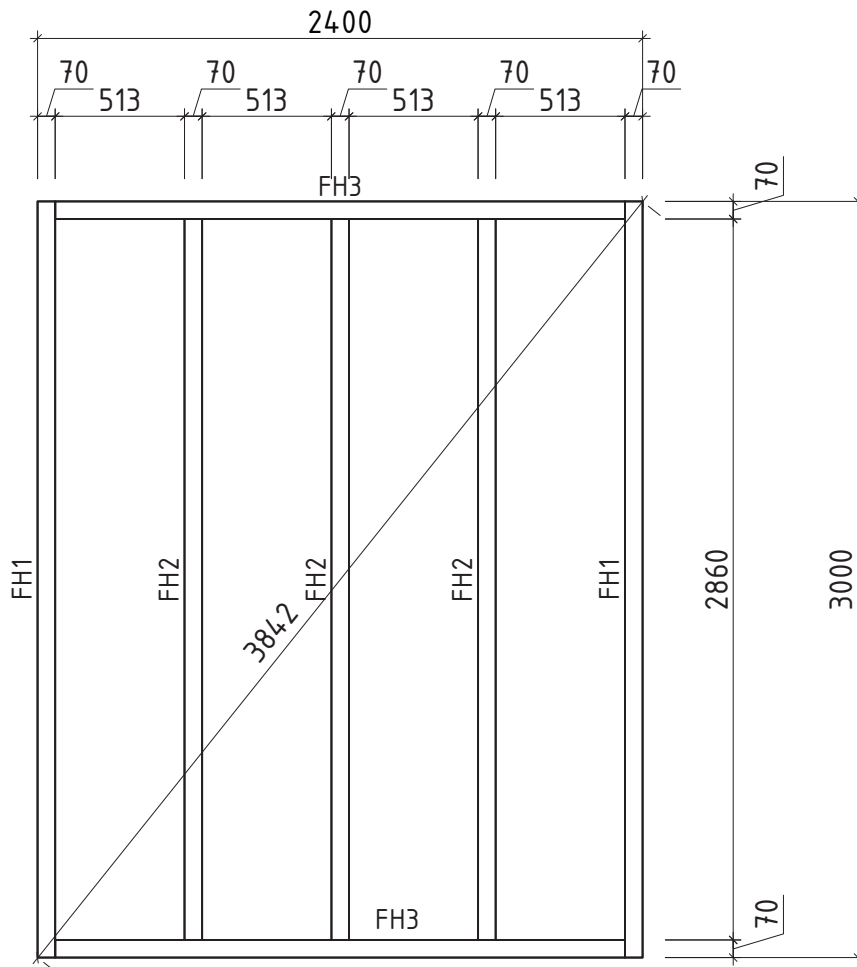

Pos	Teilleiste Pulti B ohne Tür_34		Stck	Profil (mm)	Länge (mm)
001			1	34x109	3400
002			1	34x114	3400
003			1	34x114	3200
004			17	34x114	3200
006			32	34x114	2600
007			2	34x57	2600
009			34	34x114	796
W1-1			1		
W2-1			1		
FH1	FUNDAMENTHÖLZER (imprägniert)		2	70x45	3000
FH2	FUNDAMENTHÖLZER (imprägniert)		3	70x45	2860
FH3	FUNDAMENTHÖLZER (imprägniert)		2	70x45	2260
PF1			2	44x145	3400
	DACHBRETTER		31+1	113x18	2805
	FUSSBODENBRETTER		26+1	113x18	2325
	FUSSBODENLEISTEN			18x40	11.0lfm
G02-1	GIEBELBRETT 18x120		2	18x120	2825
G05-1	GIEBELDECKLEISTEN 18x40		2	18x40	2805
T02-1	TRAFENBRETT 18x120		1	18x120	3436
T01-1	TRAFENBRETT 18x95		1	18x95	3400
T04-1	TRAFENDECKLEISTEN 18x40			18x40	3.5lfm
T06-1	TRAFENLEISTEN 18x40			18x40	7.0lfm
SM-1	Sturmleisten		2	18x40	1940
SM-2	Sturmleisten		2	18x40	2050
SH	Schlaghölzer		3		
Kood	Pulti B ohne Tür_34		Materjal	Leht 1/2	

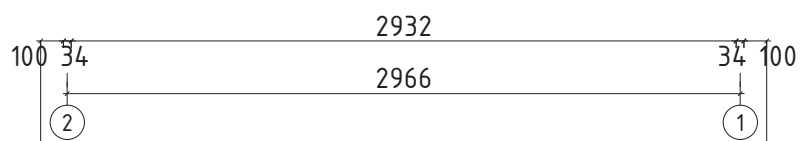
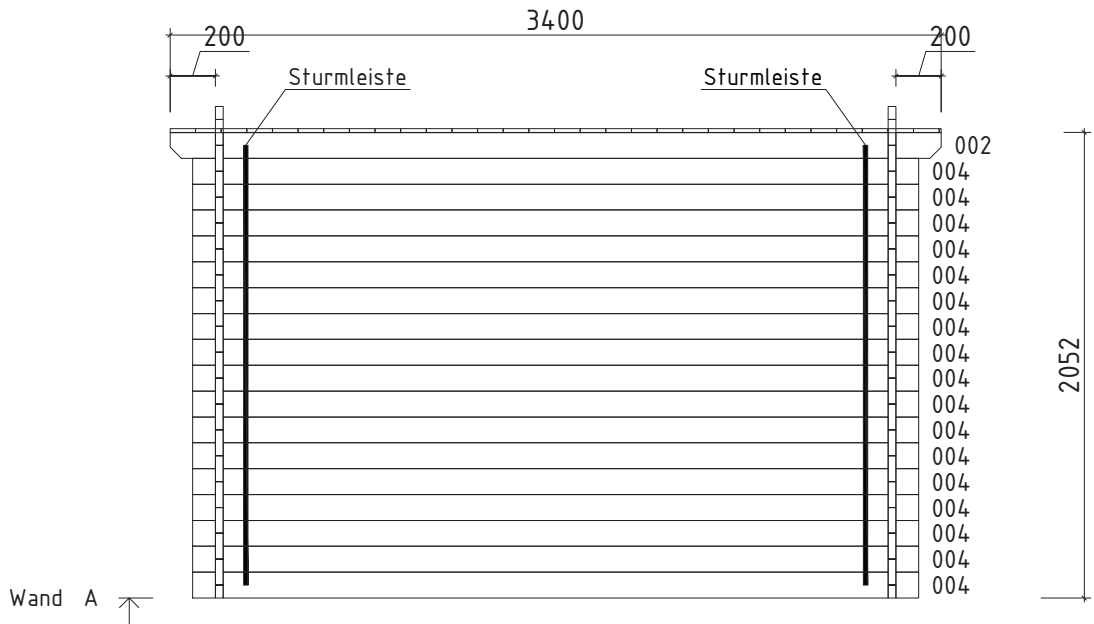
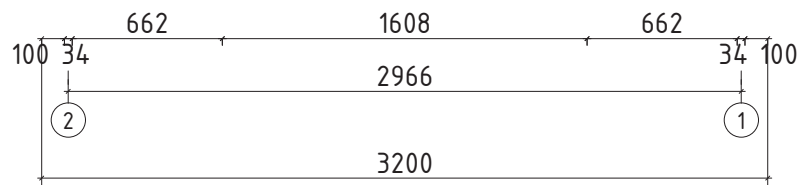
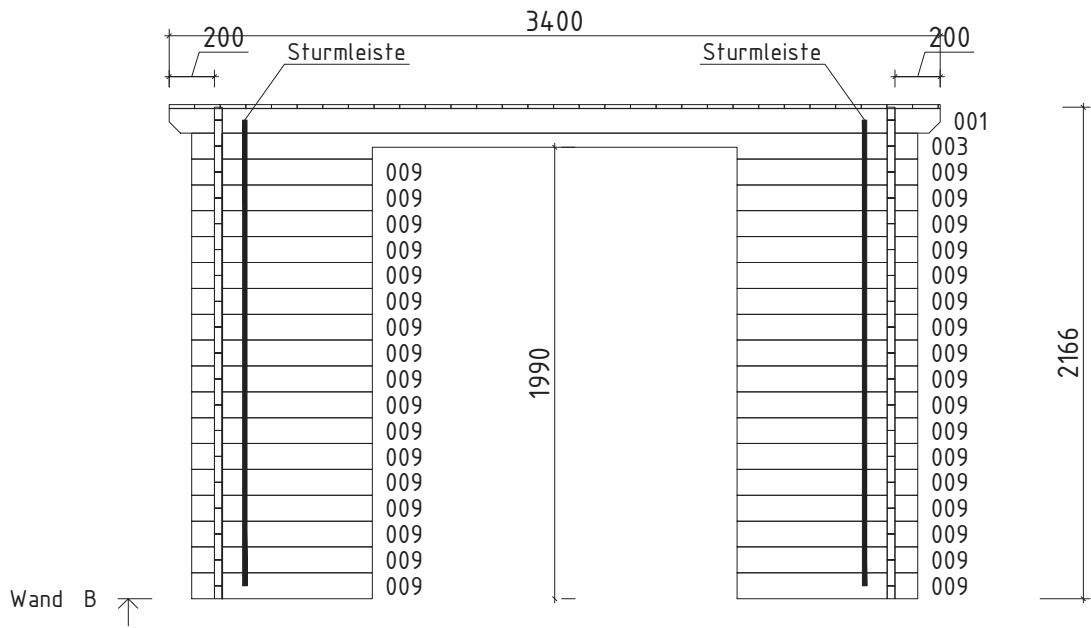

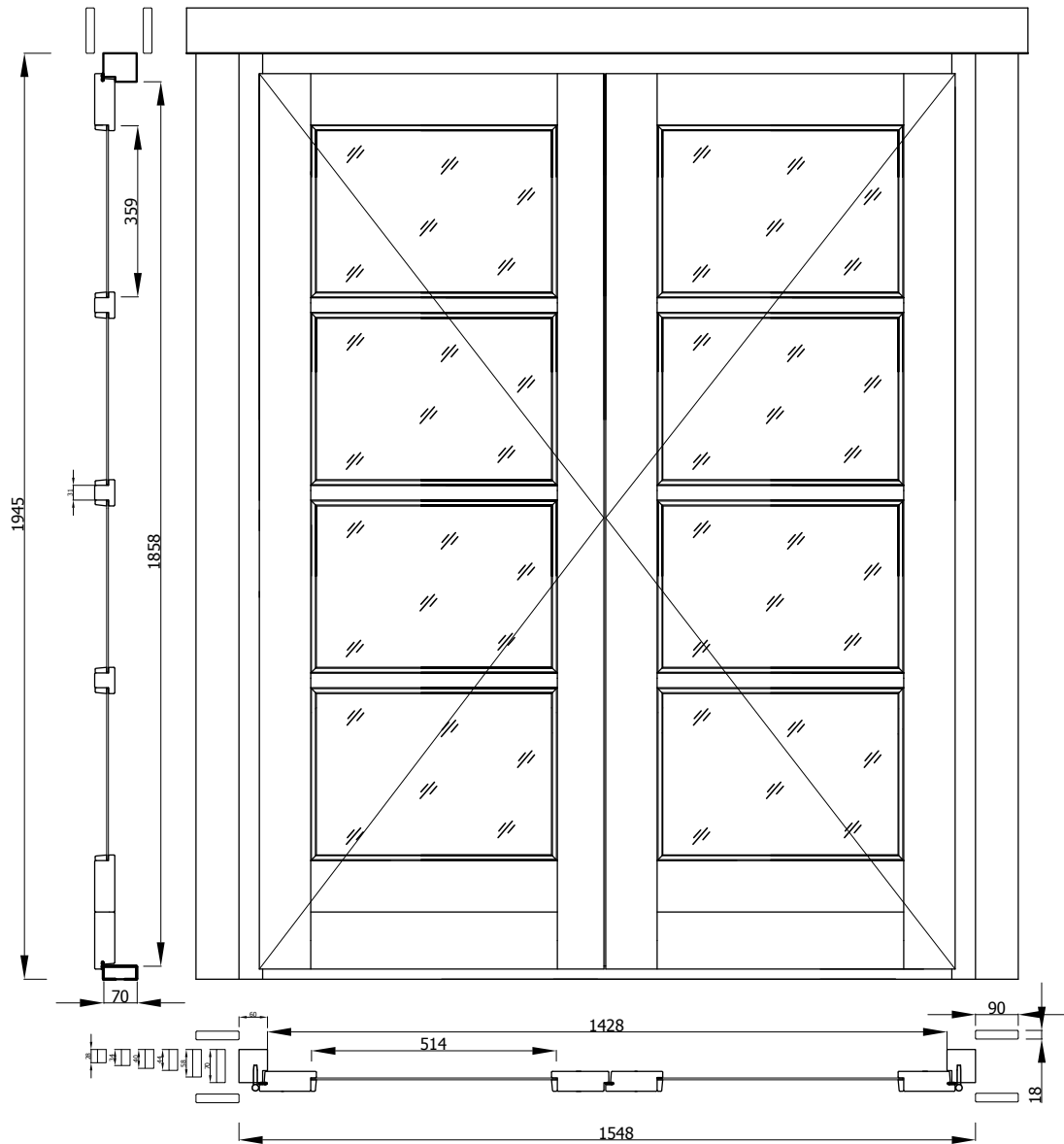

Lochmaß: 1588 x 1965 mm
Rahmenaußenmaß: 1548 x 1945 mm
Durchgangsmaß: 1428 x 1858 mm
Glasmaß: 514 x 359 mm
Glasstärke: 4 mm

Technische Daten: Art.-Nr.: 700 200

Wandaußenmaß: 150 x 300 cm



Kontrolliert durch:

Achtung: Alle angegebenen Maße sind ca.-Maße!

3D-Darstellung Art.-Nr. 700 200

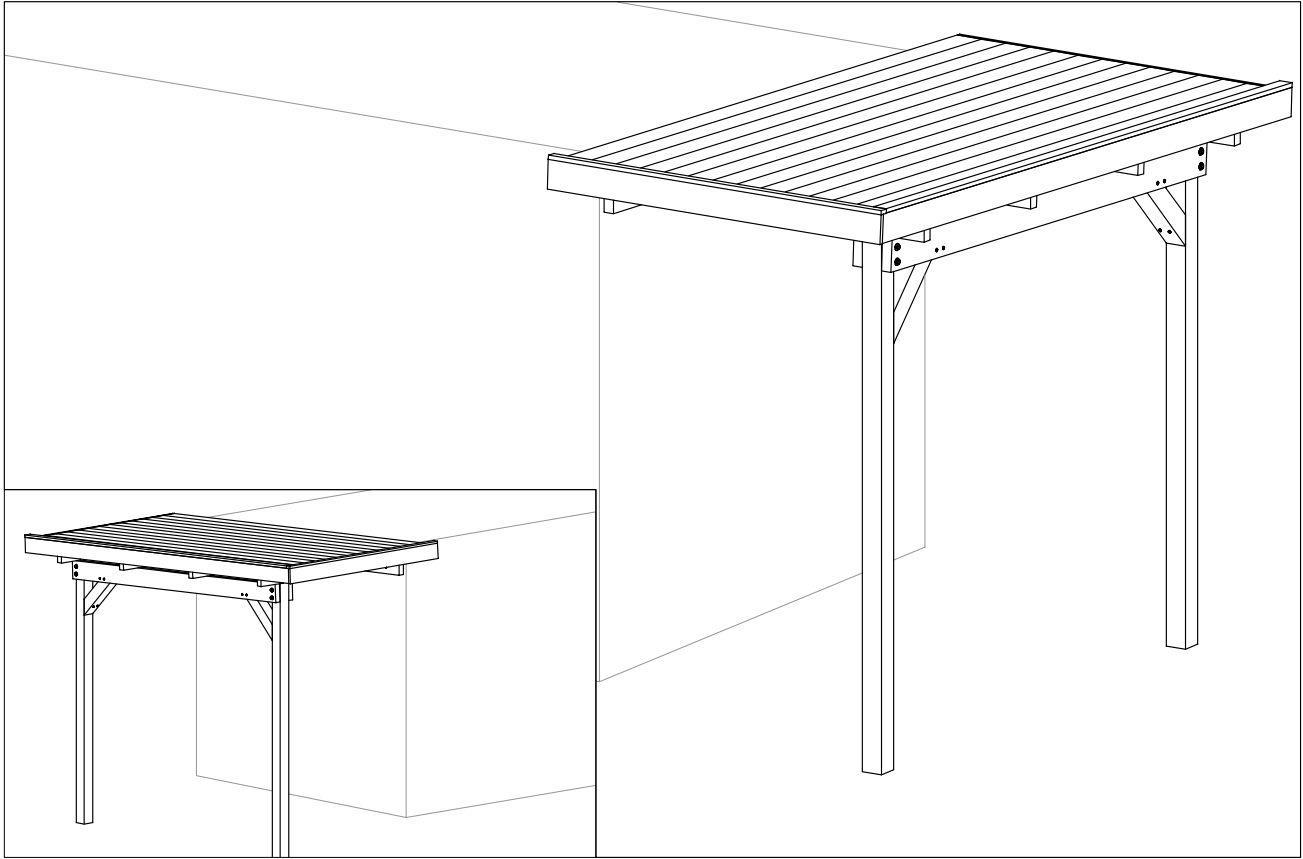





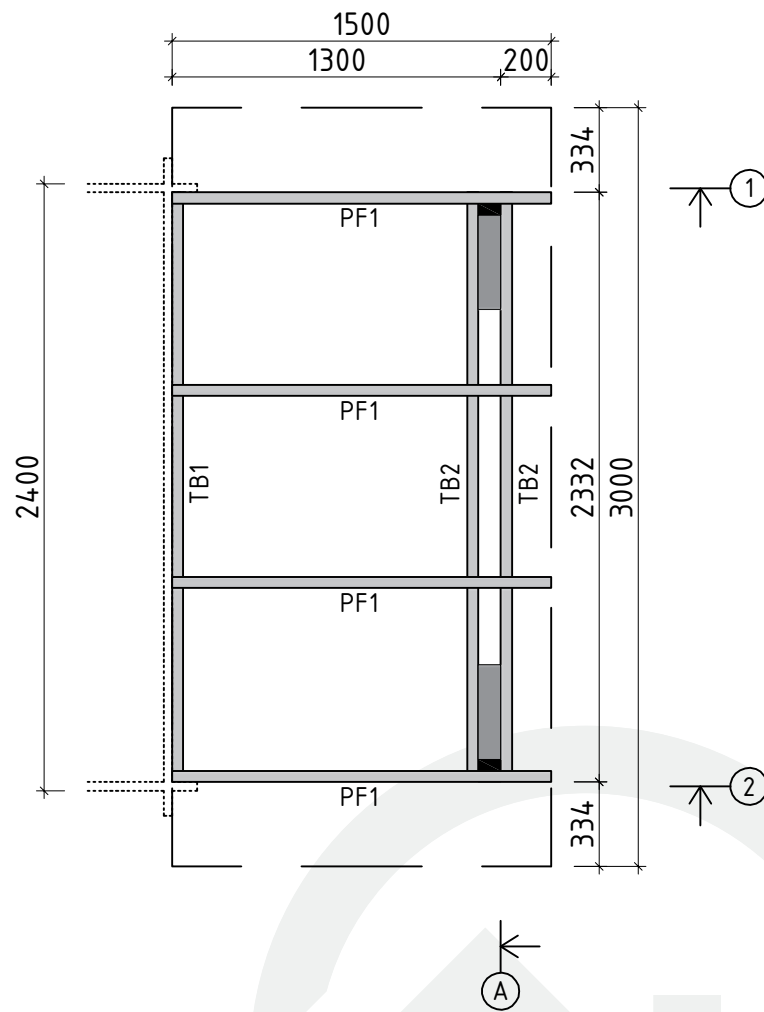





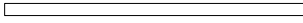

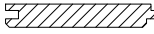
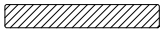



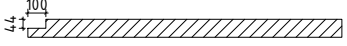

Grundriss

Art.-Nr. 700 200

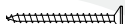
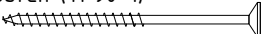

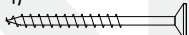
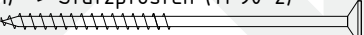
Teileliste 1

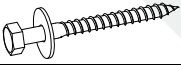
Art.-Nr. 700 200

Pos		Stck	Profil (mm)	Länge (mm)
TB2	TRÄGEBALKEN 	2	44x145	2330
TB1	TRÄGEBALKEN 	1	44x94	2330
PF1	PFETTEN 	4	44x145	1500
	DACHBRETTER 	14+1	113x18	3005
G02-1	GIEBELBRETTER 18x120 	1	18x120	3025
G05-1	GIEBELDECKLEISTEN 18x40 	1	18x40	3025
T02-1	TRAUFBRETTER 18x120  ✓	1	18x120	1520
T01-1	TRAUFBRETTER 18x90  ✓	1	18x90	1520
T04-1	TRAUFENDECKLEISTEN 18x40  ✓	1	18x40	1520
T06-1	TRAUFENLEISTEN 18x40  ✓	2	18x40	1520
TP90-1	STÜTZPFOSTEN 90x90 	2	90x90	550
TP90-2	STÜTZPFOSTEN 90x90  ✓	2	90x90	2310
W01	Winkel 40x40x40 	4		
NG01	DACHPAPPNÄGEL 2.8x15 	100		
NG04	NÄGEL 2.5x50 Dachbretter 	112		
SR32	SCHRAUBEN 3.0x30 Giebeldeckleisten Traufenleisten, Traufendeckleisten 	15		
SR37	SCHRAUBEN 3.5x45 Giebelbretter, Traufenbretter 	12		
SR57	SCHRAUBEN 5.0x100 Trägebalken (TB2) -> Stützpfeosten (TP90-1) 	8		
SR51	SCHRAUBEN 5.0x30ÜP Winkel (W01) 	32		
SR55	SCHRAUBEN 5.0x70 Stützpfeosten (TP90-2) -> Pfetten (PF1) 	4		
SR61	SCHRAUBEN 6.0x140 Stützpfeosten (TP90-1) -> Stützpfeosten (TP90-2) 	4		
SS32	Schloßschrauben M8x100 Mutter M8 U-Scheibe Ø25 	9	M8	
SS56	Sechskant Holzschrauben M10x100 U-Scheibe M10 Ø30 	8	M10	
KP-1	DACHPAPPE  ✓		1,8m-4st.	8,0 lfm
	✓ - bitte selber anpassen (falls nötig!)			

Wandplan 1 und 2

Art.-Nr. 700 200

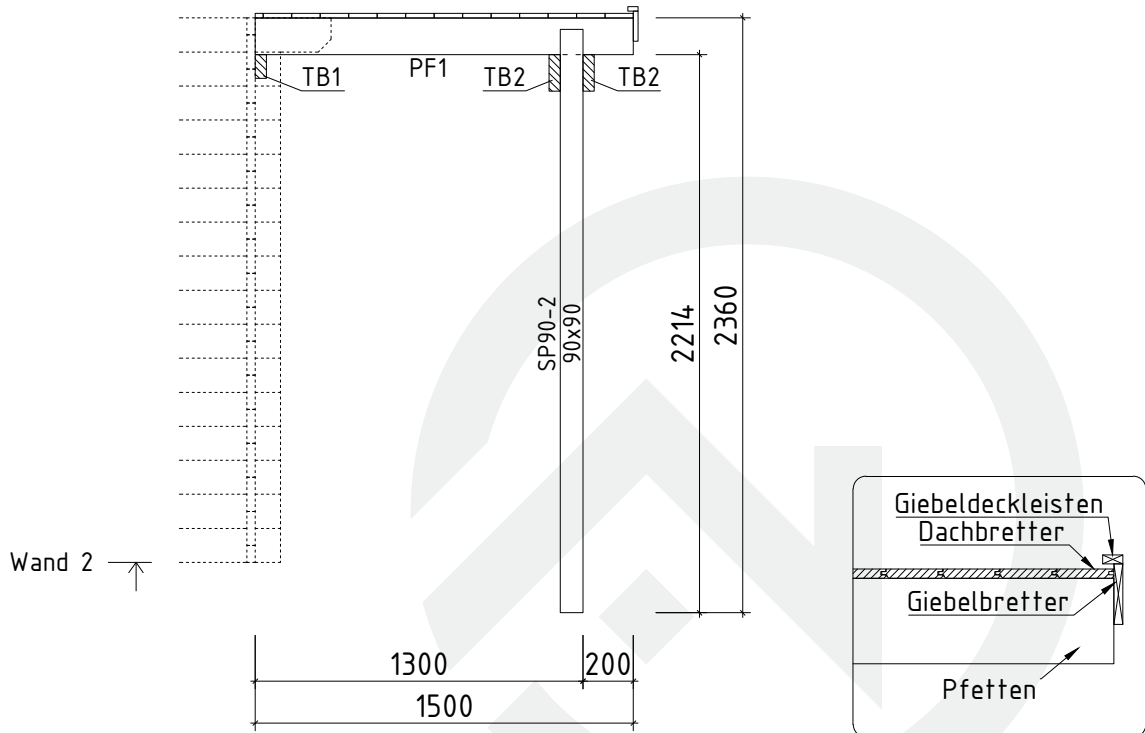
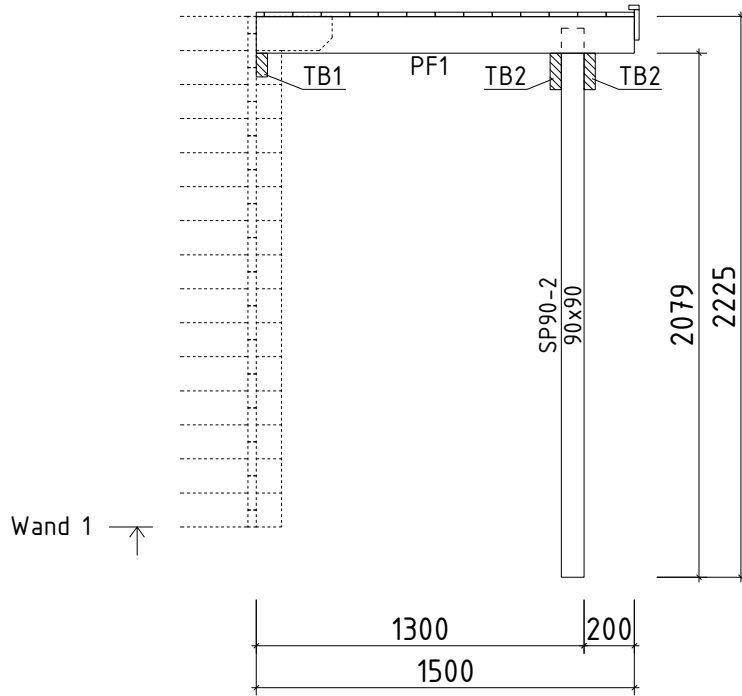

Wandplan A

Art.-Nr. 700 200

