



Paulmann

Safety Instructions

1, 2, 3, 4, 5, 6, 7, 8, 9, 19, 21, 24, 25, 26, 27, 28, 34



Info

www.paulmann.com

Paulmann Licht GmbH
Quezinger Feld 2
31832 Springe
Germany

www.paulmann.com

Art.-Nr.:
500.17



1x

Bluetooth Master Switch

INPUT: 220-240V~50Hz max.2.5A

OUTPUT: 220-240V~50Hz

max.500W (Resistive Load)

max.75W (Capacitive Load)



(+MA 0326)PKE 08/17



A

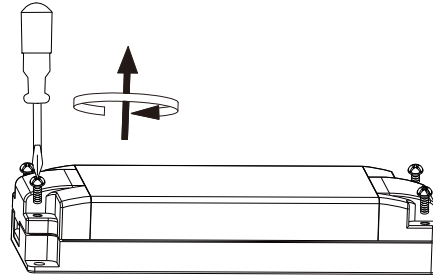

Safety Instructions
Nr. 1, 2, 4

B

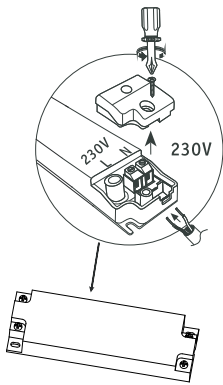

INPUT:
OUTPUT:

1.

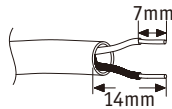

7mm

14mm

2.

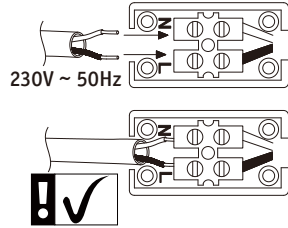

230V ~ 50Hz

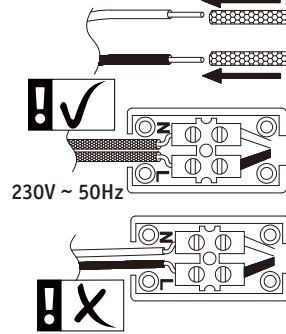

230V ~ 50Hz



Safety Instructions
Nr. 4,5,6

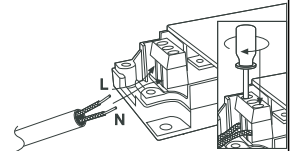

C

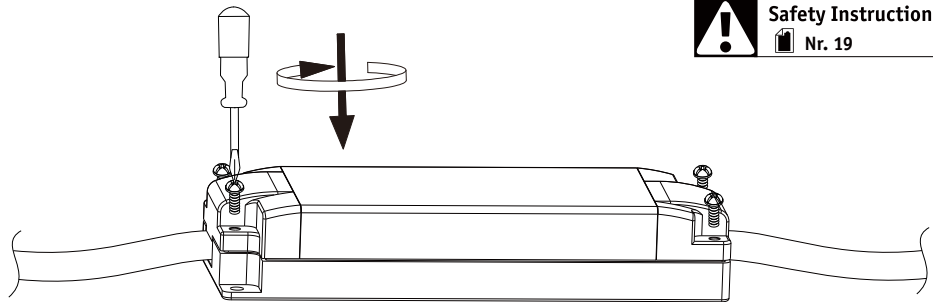

Safety Instructions
Nr. 19



D

1.

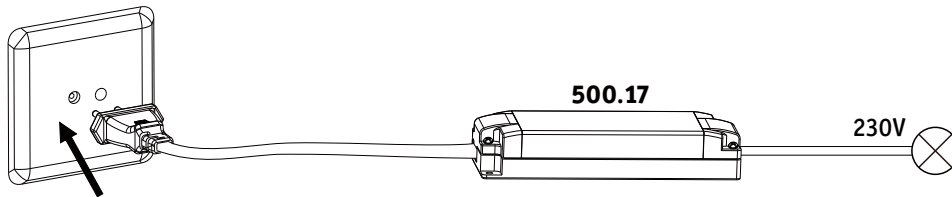

500.17

230V

2.

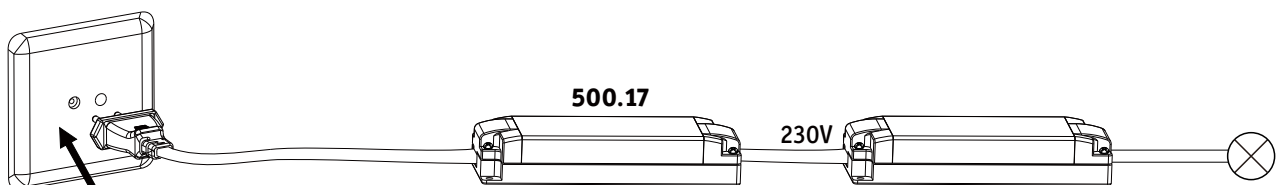

500.17

230V

Trans Former/
LED Driver



Safety Instructions
Nr. 19



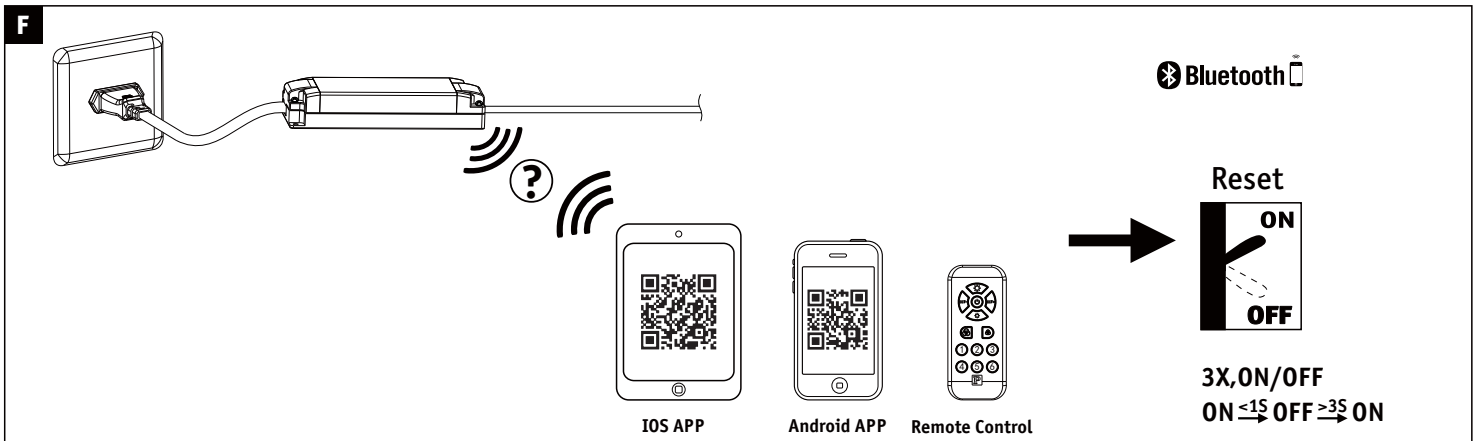
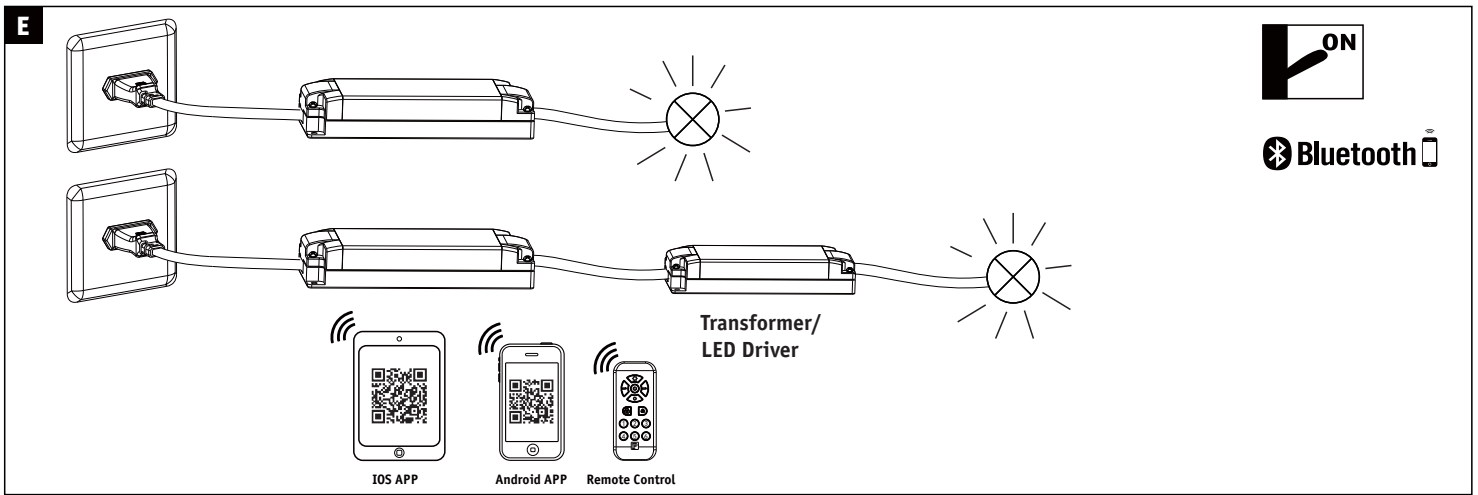

G

Paulmann Home

IOS APP

Android APP

- iPad
- iPhone 4S Higher
- Android 4.4 Higher
- Bluetooth 4.0 Higher

Not incl.

Not incl. Remote Control

Paulmann
Art.-Nr.500.01

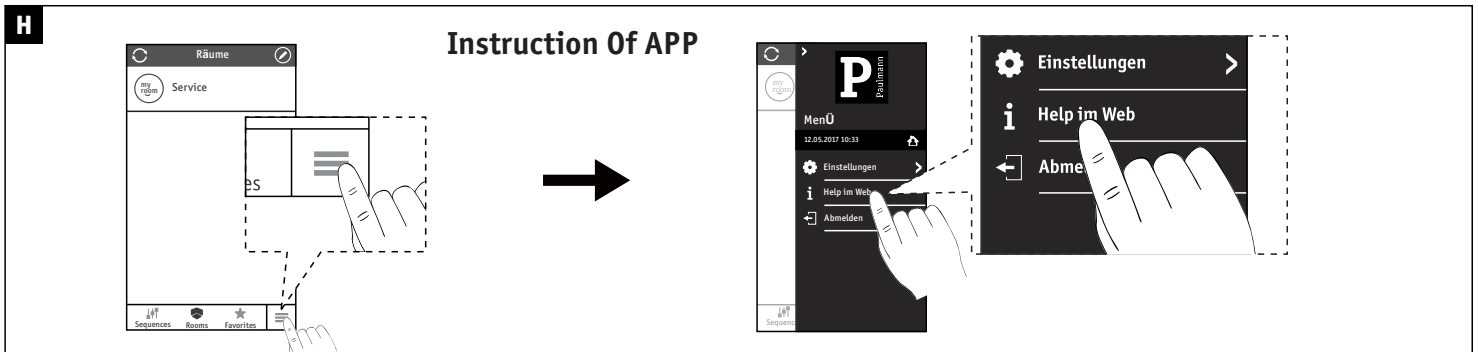

Hiermit erklärt Paulmann Licht, dass der Funkanlagentyp Art.-Nr: 500.17 Richtlinie 2014/53/EU entspricht. Der vollständige Text der EU-Konformitätserklärung ist unter der folgenden Internetadresse verfügbar: www.paulmann.de

Zugelassen für den Betrieb in allen Ländern der EU / Approved for operating in all European countries

CE: Konform mit / in accordance with / conformément a 2014/30/EU, 2014/53/EU <http://www.paulmann.com/de/de/b2b-haendler-log-in.html>

Funk-Frequenz 2,4 GHz - 2,4835 GHz. Abgestrahlte Energie 10mW



doesn't apply for the geographical area within a radius of 20km from the centre on "Ny Alesund"