

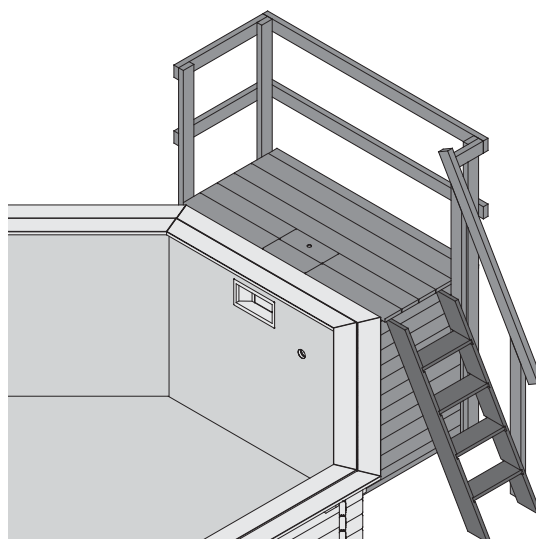

25674

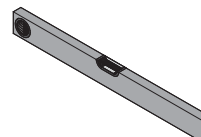

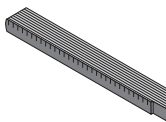
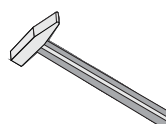
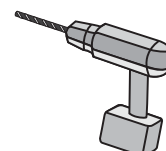
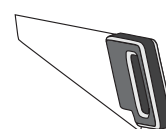

-  **Aufbauanleitung**
-  **Building Instructions**
-  **notice de montage**
-  **montagehandleiding**
-  **Montagevejledning**
-  **Instrucciones de construcción**
-  **Istruzioni per il montaggio**
-  **Montážní návod**





 Vergleichen Sie zuerst die Material-liste mit Ihrem Paketinhalt! Bitte haben Sie Verständnis, dass Beanstandungen nur im nicht aufgebauten Zustand bearbeitet werden können!

 Vergelijk eerst de lijst van materialen met de inhoud van uw pakket! Reclamaties kunnen alleen in behandeling worden genomen zolang de onderdelen nog niet zijn gemonteerd!

 Confrontate questa distinta materiali prima con il contenuto del pacchetto! Vi preghiamo di comprendere che eventuali reclami possono essere accolti solo prima del montaggio!

 First compare the list of materials with your package contents! Please understand that complaints can be processed in the non-built status only!

 Start med at kontrollere materialelisten med indholdet af den leverede pakke! Vi gør venligst opmærksom på at reklamationer kun kan behandles for materialer som ikke er blevet bearbejdet!

 Nejprve překontrolujte obsah balení podle materiálového listu! Mějte pochopení pro to, že případnou reklamaci se můžeme zabývat pouze tehdy, když díly nebudou smontované! Za pomoci tohoto seznamu můžete jednotlivé díly přiřadit k montážnímu návodu.

 Commencez par comparer la liste du matériel avec le contenu de votre paquet! Sachez que nous traitons uniquement les réclamations concernant le matériel à l'état non monté!

 En primer lugar, compare la lista de material con el contenido del paquete. Rogamos entienda que las reclamaciones sólo pueden ser tramitadas antes de montar el objeto!

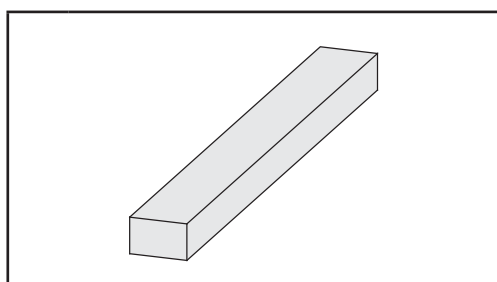
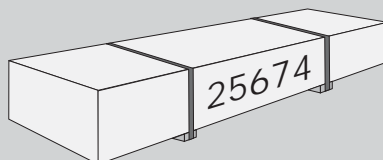

2 x B1	285 x 45 x 18 mm	ID 44871
2 x B2	355 x 140 x 26 mm	ID 49534
4 x B4	820 x 140 x 26 mm	ID 49502
4 x B5	2007 x 140 x 26 mm	ID 49501
2 x B6	80 x 58 x 28 mm	ID 7205
2 x B7	1040 x 58 x 28 mm	ID 39736
12 x B8	1170 x 58 x 28 mm	ID 39735
2 x B9	943 x 60 x 40 mm	ID 39733
1 x B10	1825 x 60 x 40 mm	ID 39750
1 x B11	235 x 90 x 40 mm	ID 37463
2 x B12	290 x 90 x 40 mm	ID 39915
2 x B13	781 x 90 x 40 mm	ID 39905
4 x B14	878 x 90 x 40 mm	ID 39913
2 x B15	1155 x 90 x 40 mm	ID 39906
2 x B16	1896 x 90 x 40 mm	ID 39918
1 x B17	1537 x 90 x 40 mm	ID 39908
2 x B18	2177 x 90 x 40 mm	ID 39919
3 x B19	2170 x 90 x 40 mm	ID 39909

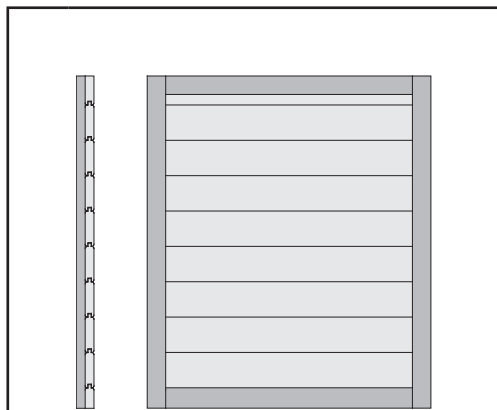

1 x D1	1043 x 890 x 28 mm	ID 39766
--------	--------------------	----------

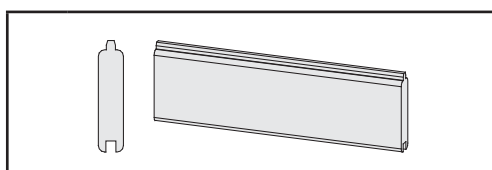

18 x G1	525 x 121 x 28 mm	ID 39921
18 x G2	890 x 121 x 28 mm	ID 39900

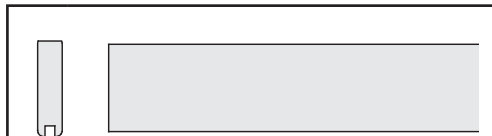

2 x G3	890 x 105 x 28 mm	ID 25734
1 x G4	1951 x 105 x 28 mm	ID 39749

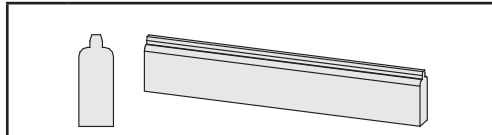

2 x G5	525 x 74 x 28 mm	ID 25802
2 x G6	890 x 74 x 28 mm	Id 25797

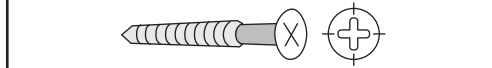

-  Edelstahl
-  stainless steel
-  acier inoxydable
-  roestvrij staal
-  rustfrit stål
-  acero inoxidable
-  acciaio inossidabile
-  nerez

15 x	4 x 35 mm	ID 39398
80 x	4 x 50 mm	ID 39399

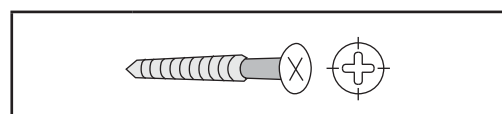

50 x	4 x 35 mm	ID 3687
270 x	4 x 50 mm	ID 3688
60 x	4 x 70 mm	ID 3689

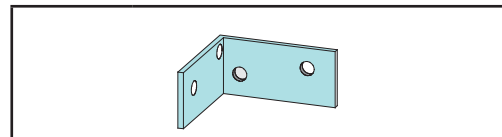

4 x		ID 21208
-----	--	----------

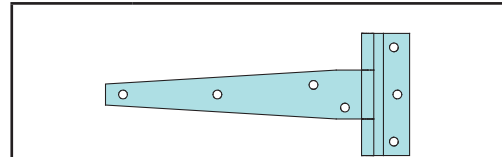

2 x		ID 3716
-----	--	---------

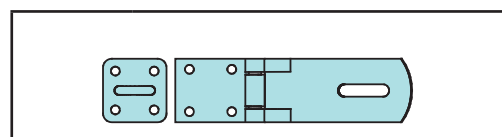

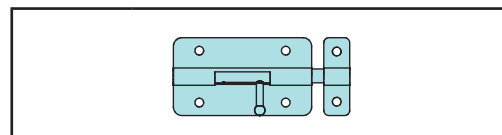

1 x		ID 3724
-----	--	---------





2 x		ID 3709
-----	--	---------

 Um das Ertrinken von Kindern zu verhindern, wird empfohlen, den Zugang zum Schwimmbecken mit einer Schutzeinrichtung zu sichern!

 For at forhindre drukning af børn anbefales det at sikre adgang til swimmingpoolen med en beskyttelsesanordning!

 To prevent the drowning of children, it is recommended to secure access to the swimming pool with a protective device!

 Para evitar que los niños se ahoguen, se recomienda asegurar el acceso a la piscina con un dispositivo de protección.





 Pour éviter la noyade des enfants, il est recommandé de sécuriser l'accès à la piscine avec un dispositif de protection!





 Per prevenire l'annegamento dei bambini, si consiglia di proteggere l'accesso alla piscina con un dispositivo di protezione!





 Om verdrinking van kinderen te voorkomen, is het aan te raden om de toegang tot het zwembad te beveiligen met een beschermend apparaat!





 Aby se zabránilo utopení dětí, doporučuje se zajistit přístup k bazénu s ochranným zařízením!



- *  Nicht im Lieferumfang enthalten
 Not included
 Non comprises dans la livraison
 Niet bijgeleverd

-  No forman parte del suministro
 Non incluso
 V ceně není zahrnuto
 Ikke inkluderet

- 1  Länge muss ermittelt und zugesägt werden
 Length must be determined and sawn
 La longueur doit être déterminée et sciée
 De lengte moet worden bepaald en worden gezaagd

-  La longitud debe ser determinada y aserrada
 La lunghezza deve essere determinata e segata
 Délka musí být určena a rozřezána
 Længden skal bestemmes og saves

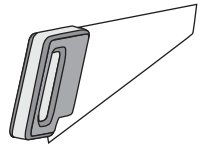
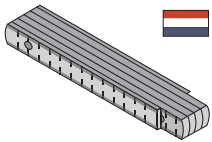



- 2  Nicht gebraucht
 Not needed
 Pas nécessaire
 Niet nodig

-  No es necesario
 Non necessario
 Není nutná

 Vorbereitung
 preparation
 préparation

 voorbereiding
 forberedelse
 preparación

 preparazione
 příprava

01

-  Bündig!
-  Flush!
-  Affleurement!
-  Gelijk!
-  I flugt!
-  Aras!
-  Combacia!
-  Stejný !

2x **W 1** !

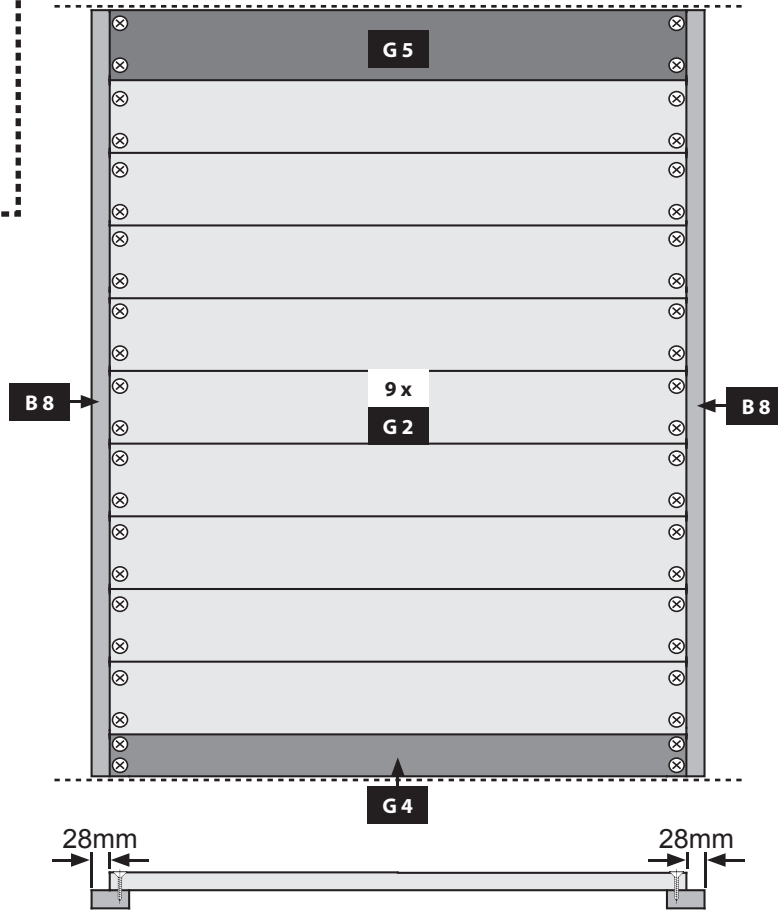
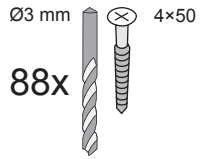

-  Rückseite
-  back
-  arrière
-  achterkant
-  bagtil
-  trasero
-  posteriore
-  zadní

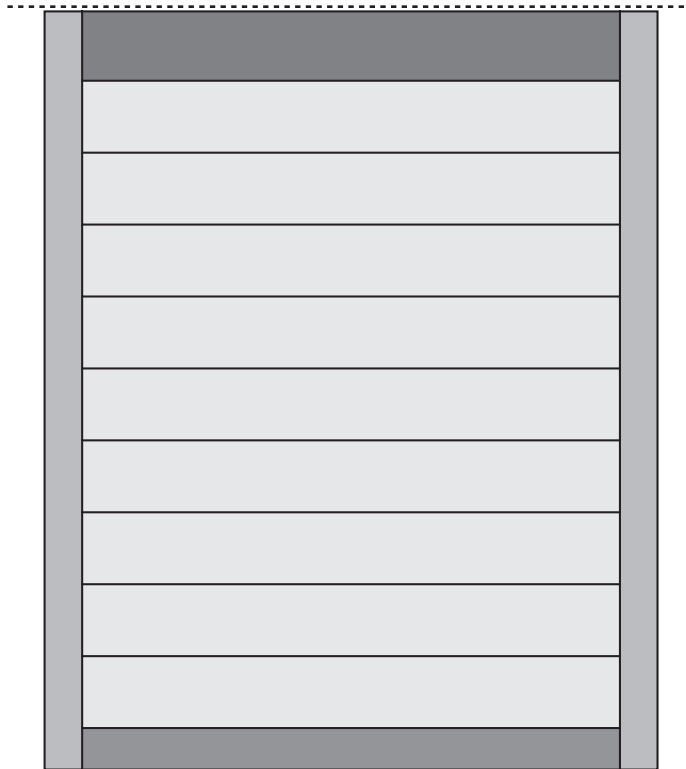

-  Draufsicht
-  Top view
-  vue de dessus
-  bovenaanzicht
-  vista desde arriba
-  vista desde arriba
-  vista dall'alto
-  pŮdorys



-  Vorderseite
-  front
-  avant
-  voorzijde
-  foran
-  frente
-  anteriore
-  přední

 Vorbereitung
 preparation
 préparation

 voorbereiding
 forberedelse
 preparación

 preparazione
 příprava

02

-  Bündig!
-  Flush!
-  Affleurement!
-  Gelijk!
-  I flugt!
-  Aras!
-  Combacia!
-  Stejný !

 **W 2**
 **W 3**

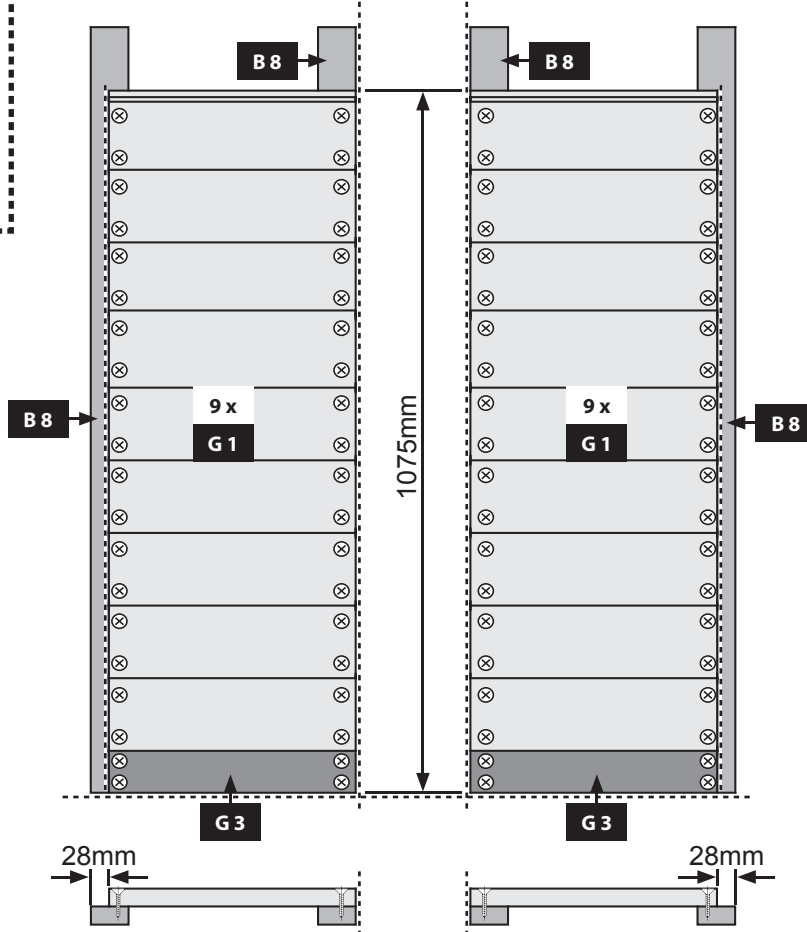
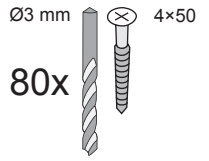

-  Rückseite
-  back
-  arrière
-  achterkant
-  bagtil
-  trasero
-  posteriore
-  zadní

-  Draufsicht
-  Top view
-  vue de dessus
-  bovenaanzicht
-  vista desde arriba
-  vista desde arriba
-  vista dall'alto
-  půdorys

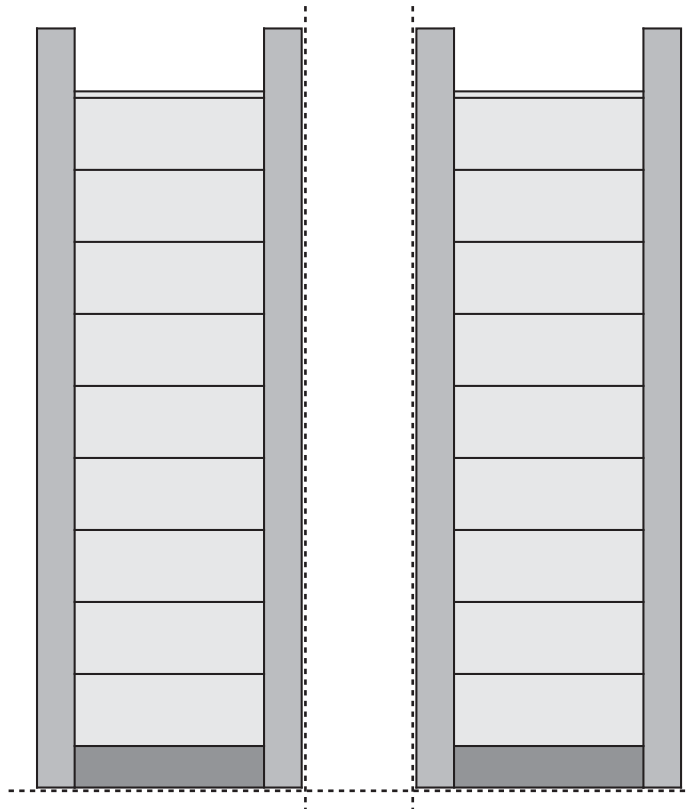

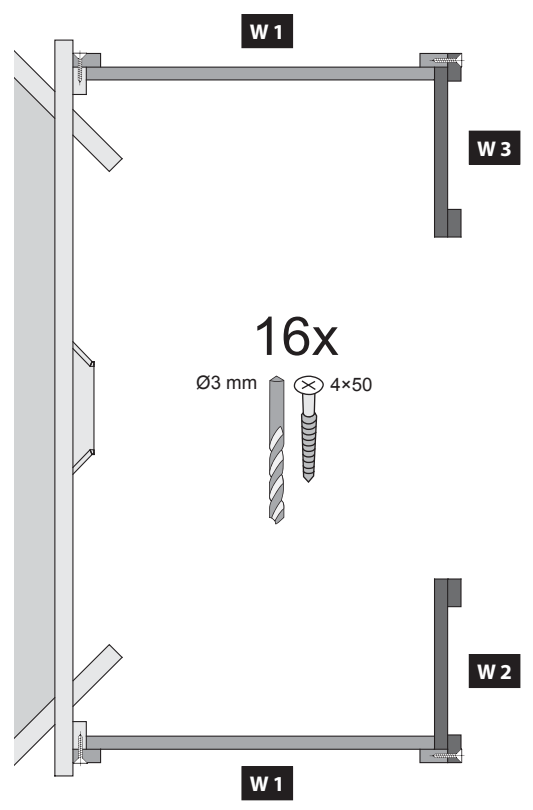
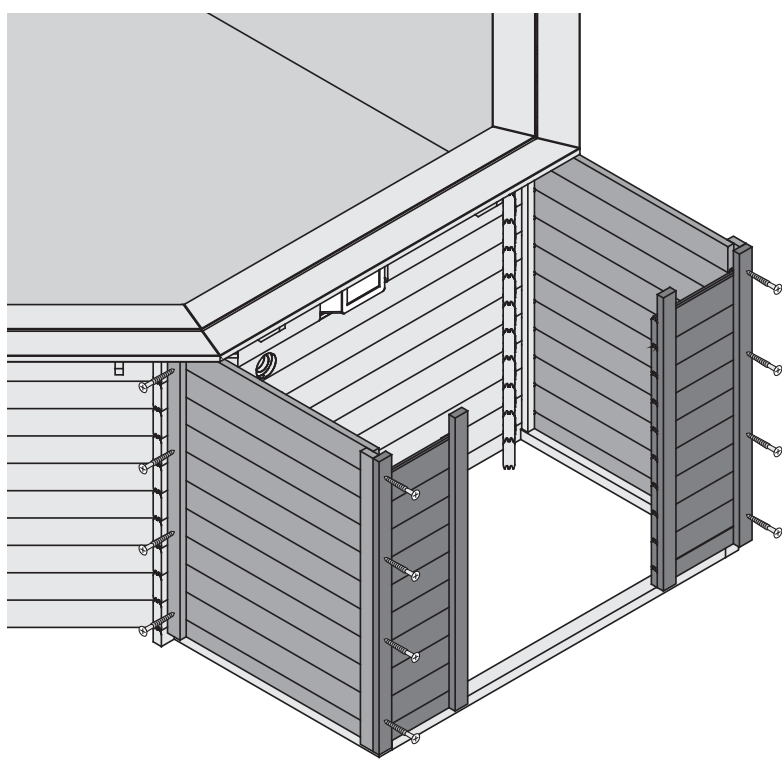
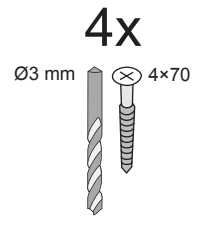
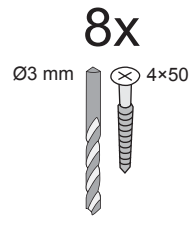
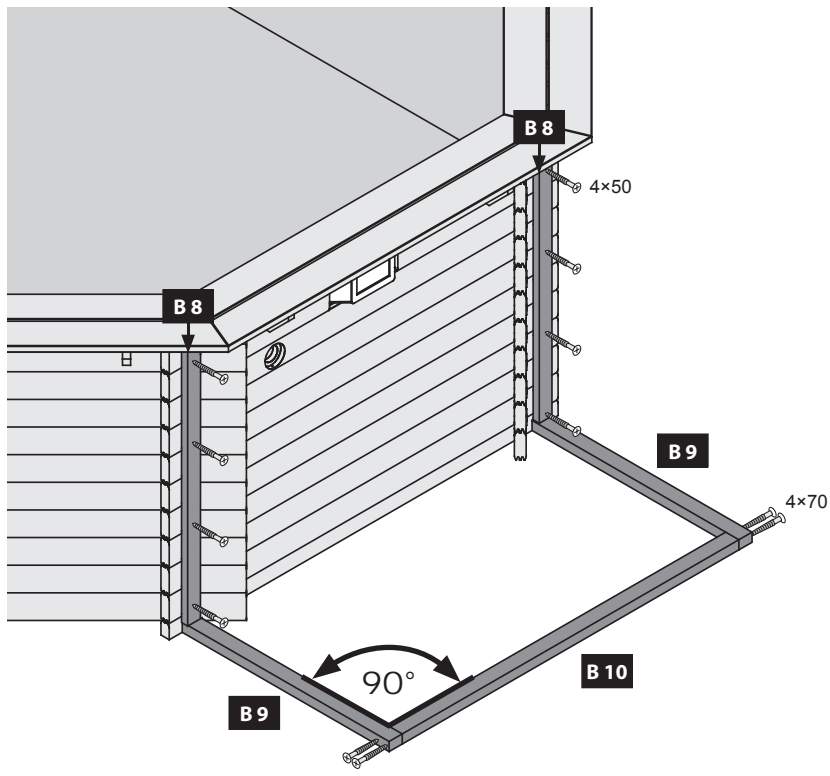

-  Vorderseite
-  front
-  avant
-  voorzijde
-  foran
-  frente
-  anteriore
-  přední

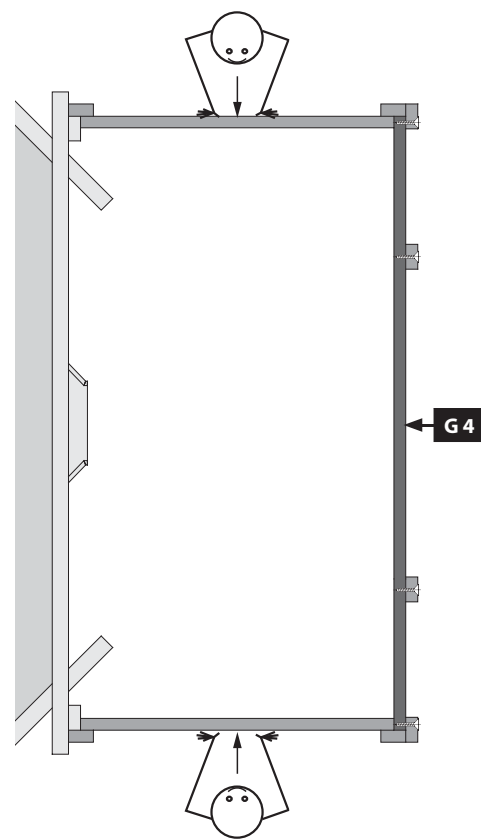
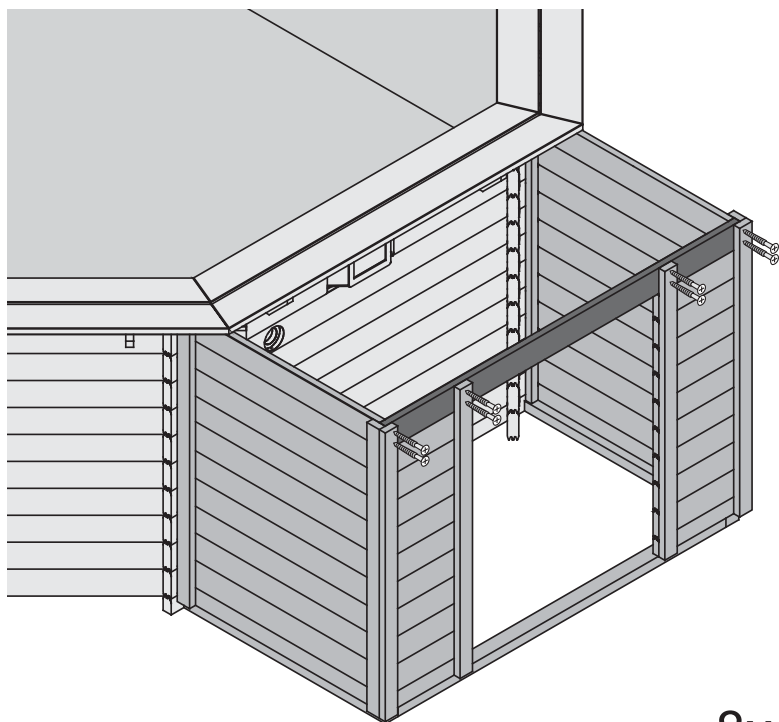



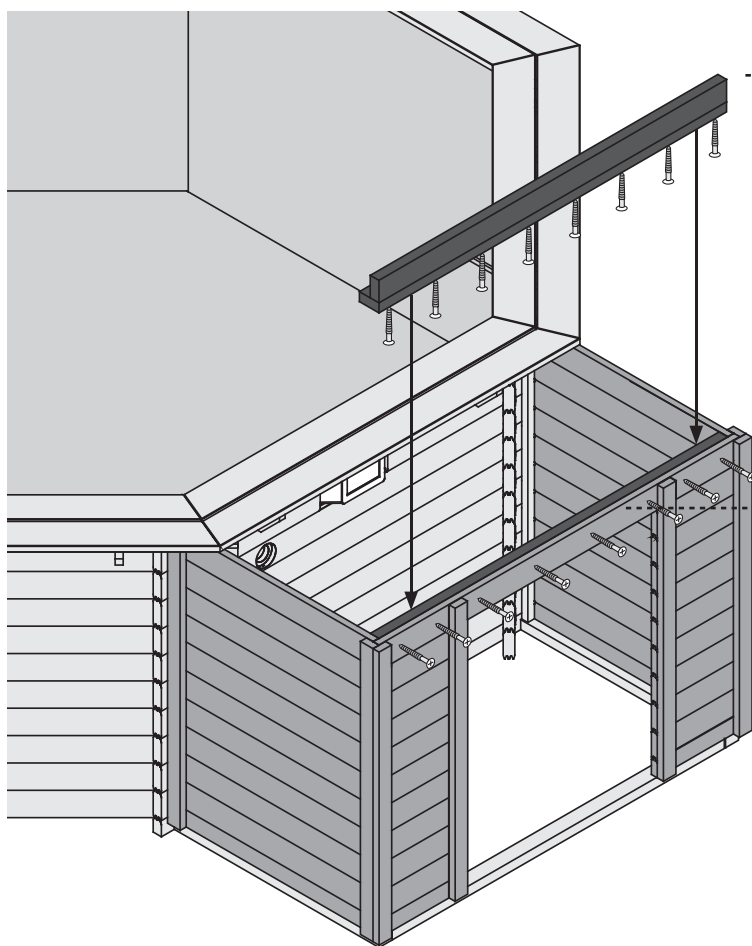

8x
 Ø3 mm  4x50

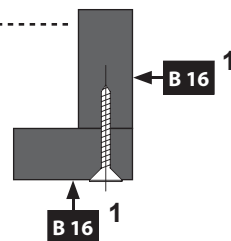

8x
 Ø3 mm  4x70



8x
 Ø3 mm  4x50

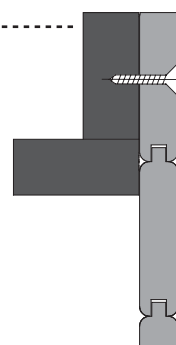

-  innen
-  binnen
-  dentro
-  Inside
-  inde
-  uvnitř
-  à l'intérieur
-  dentro

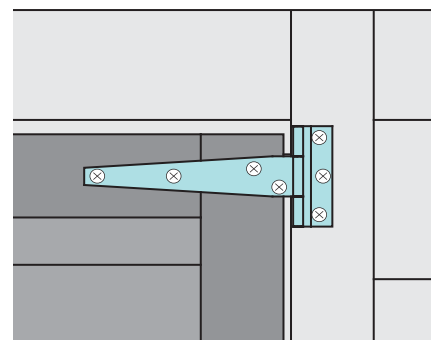
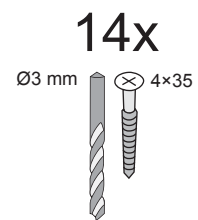
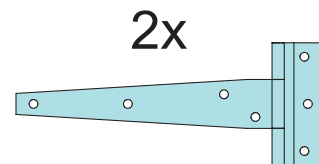
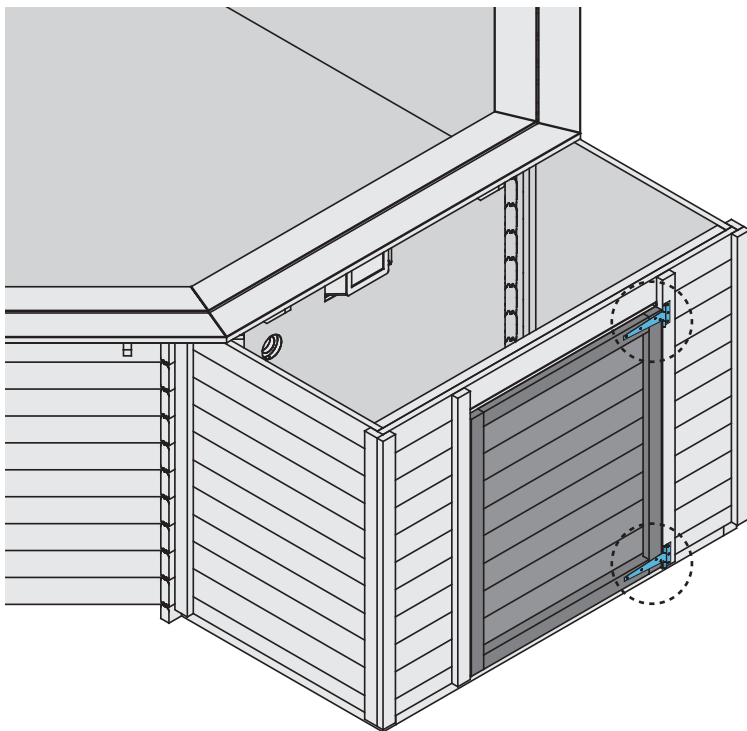
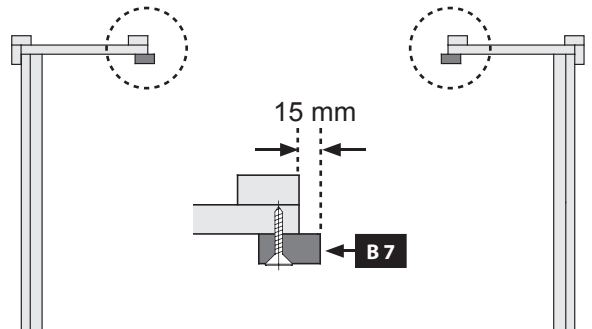
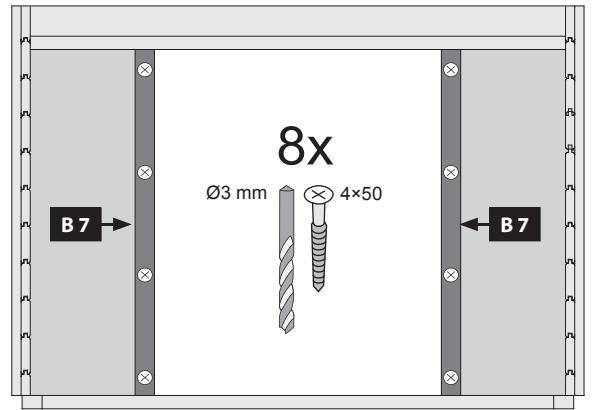
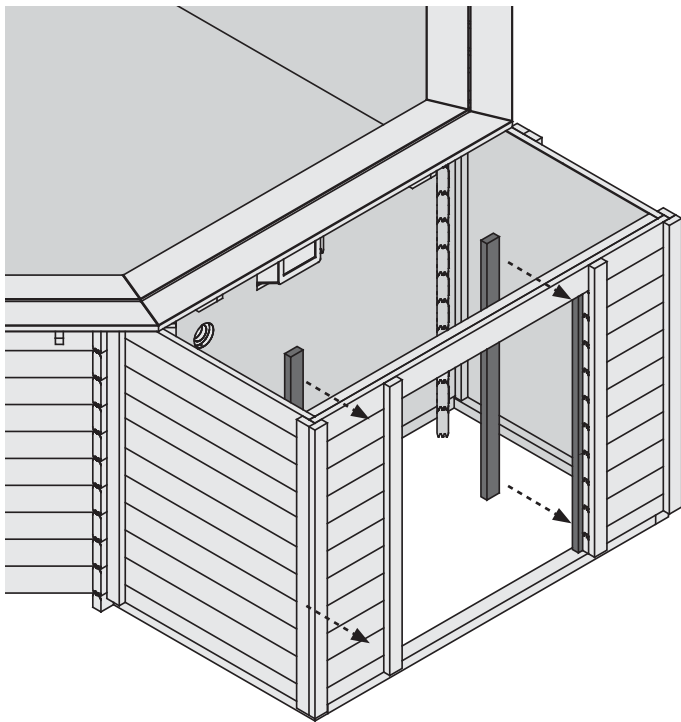

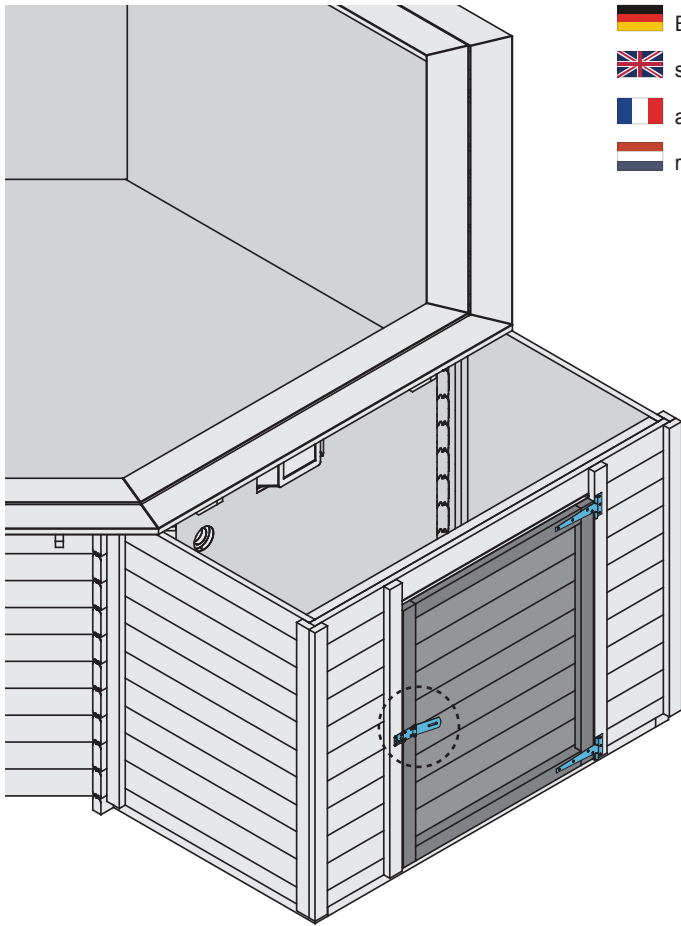

-  Edelstahl
-  stainless steel
-  acier inoxydable
-  roestvrij staal

-  rustfrit stål
-  acero inoxidable
-  acciaio inossidabile
-  nerez

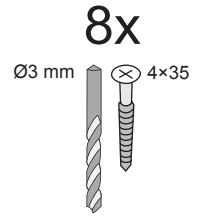

1.

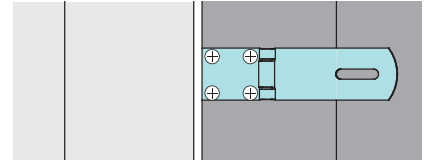

2.

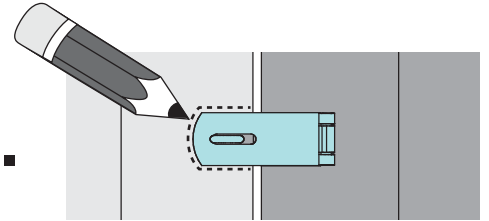

3.

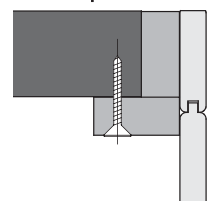
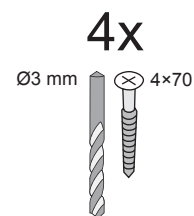
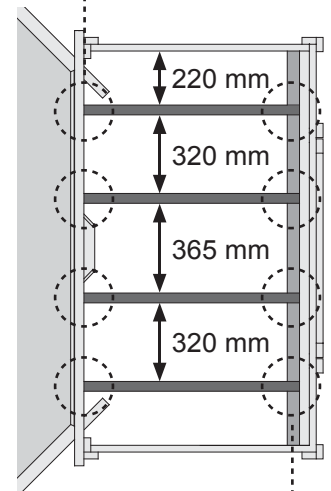
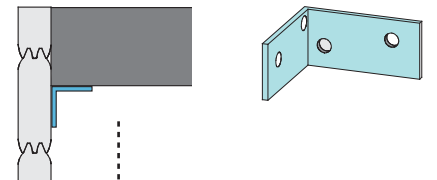
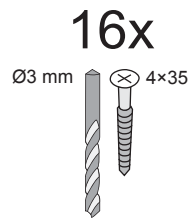
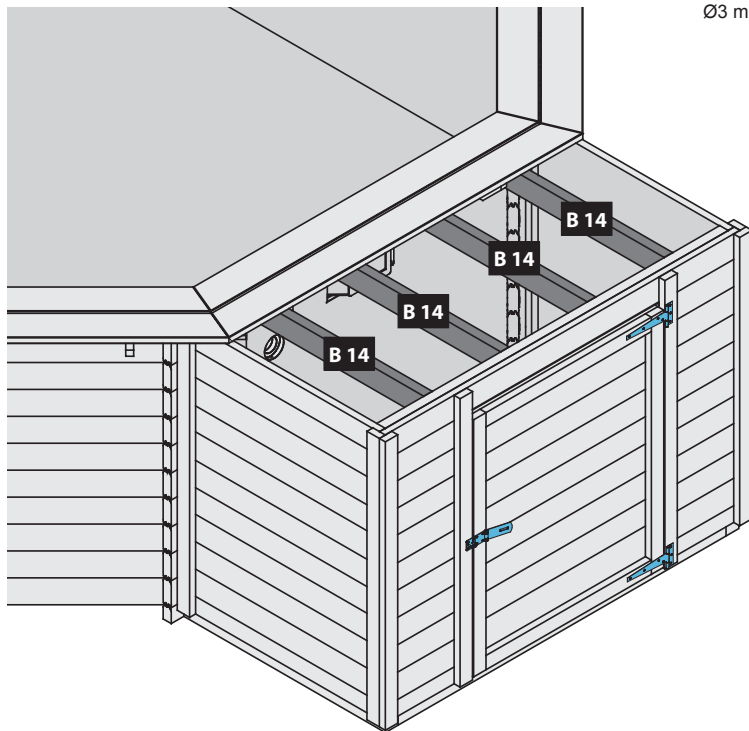
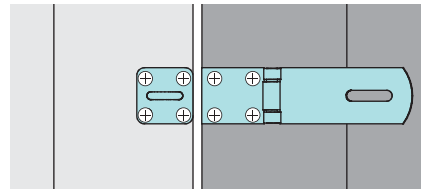

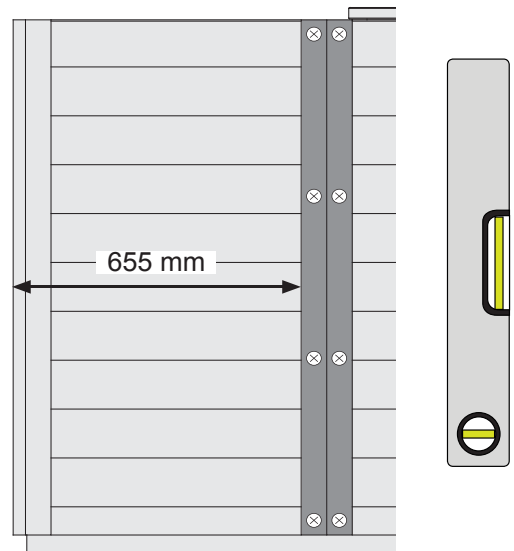
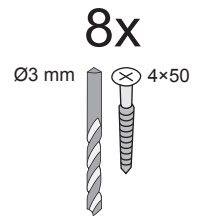
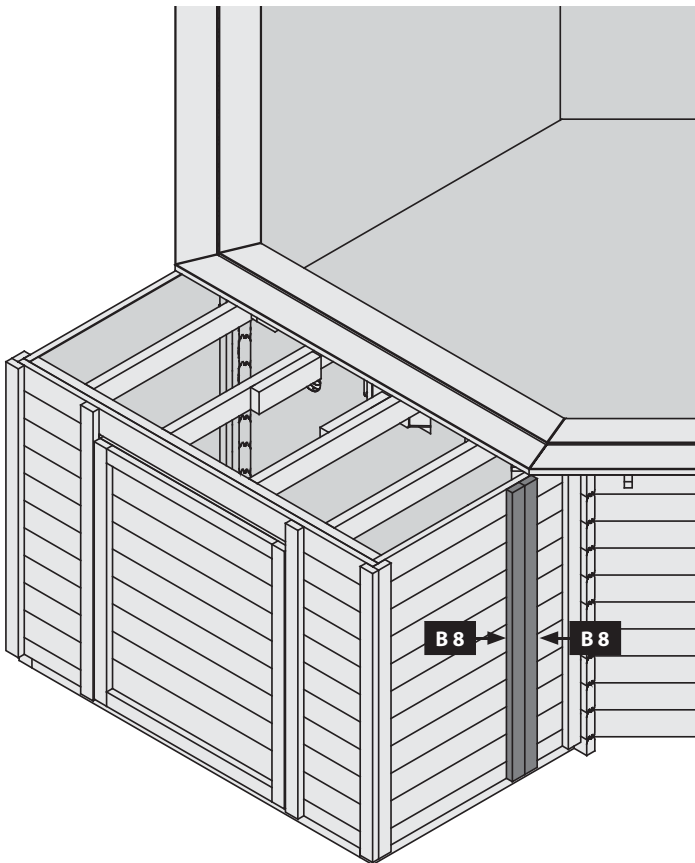
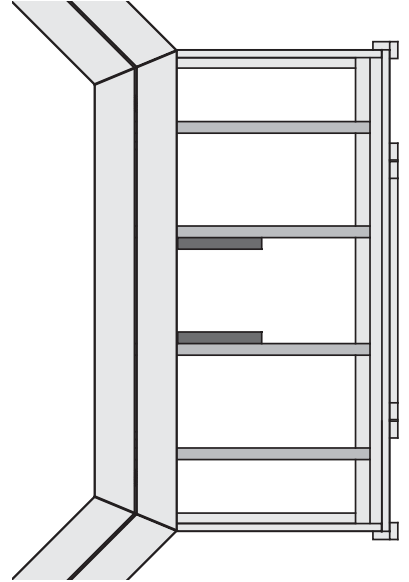
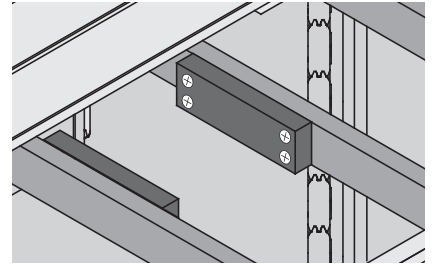
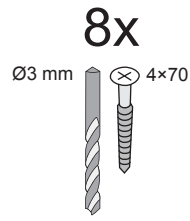
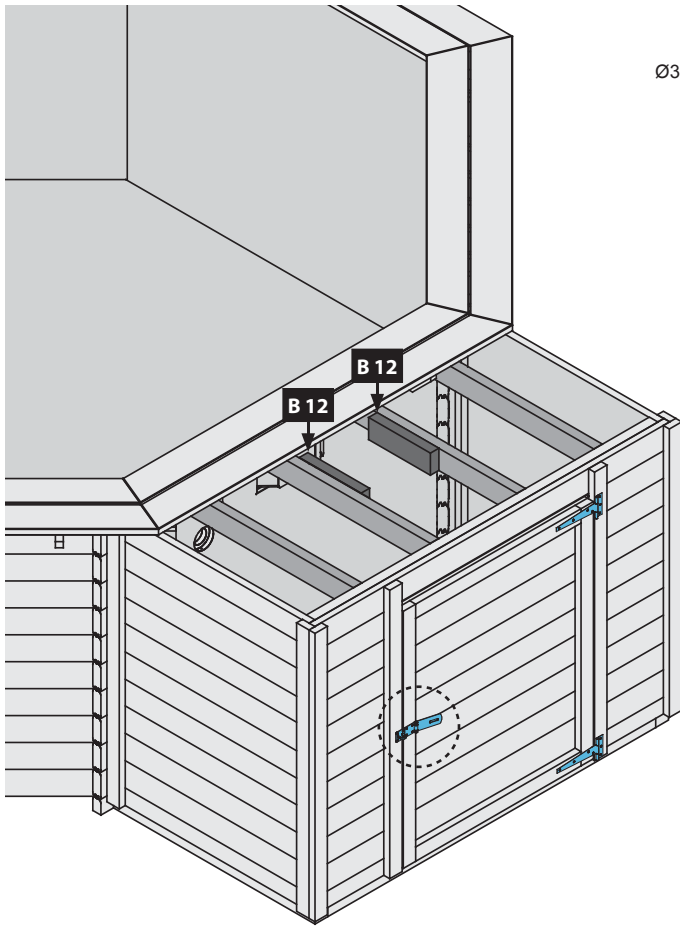

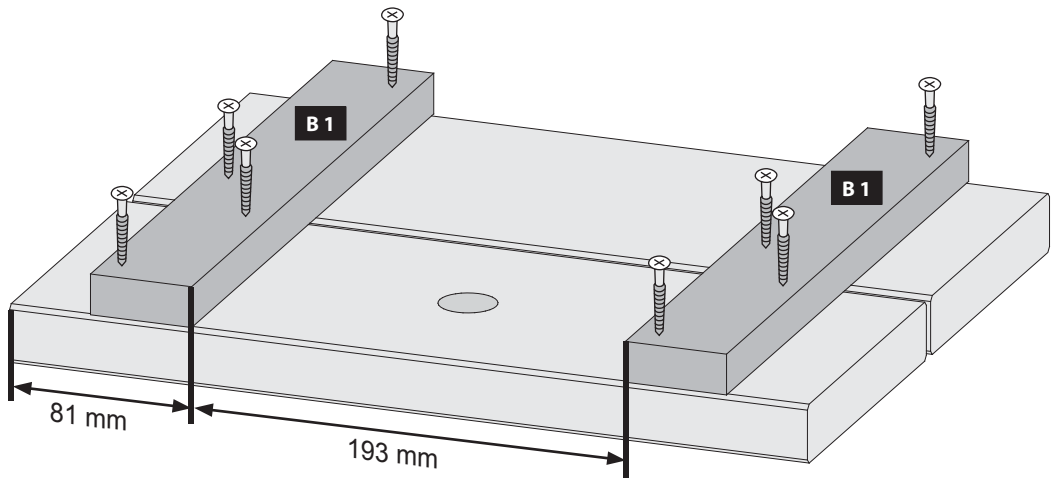
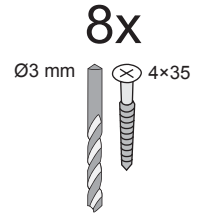
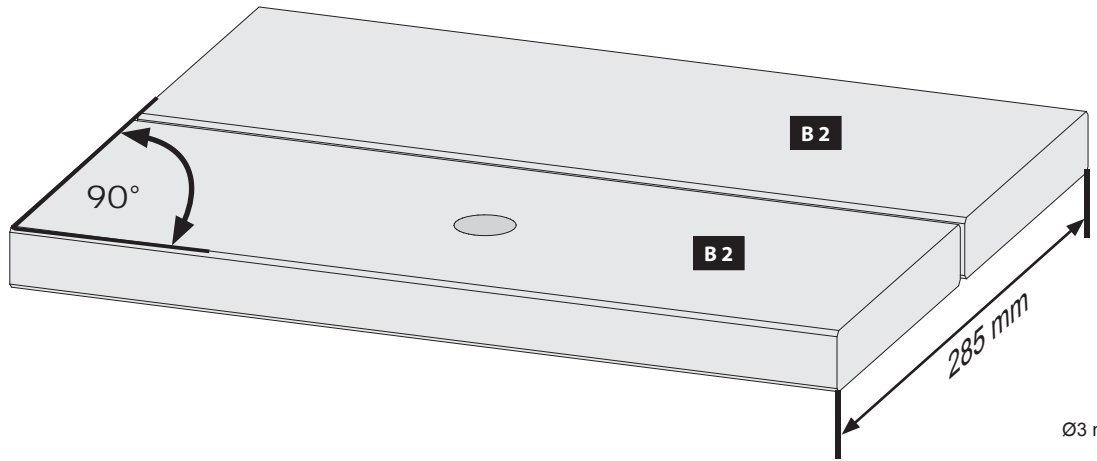
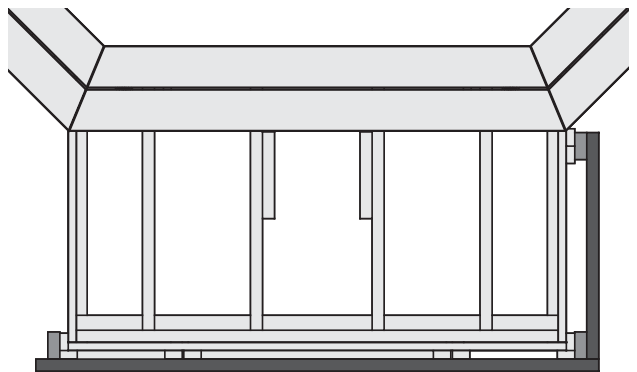
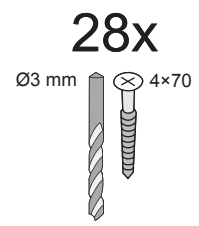
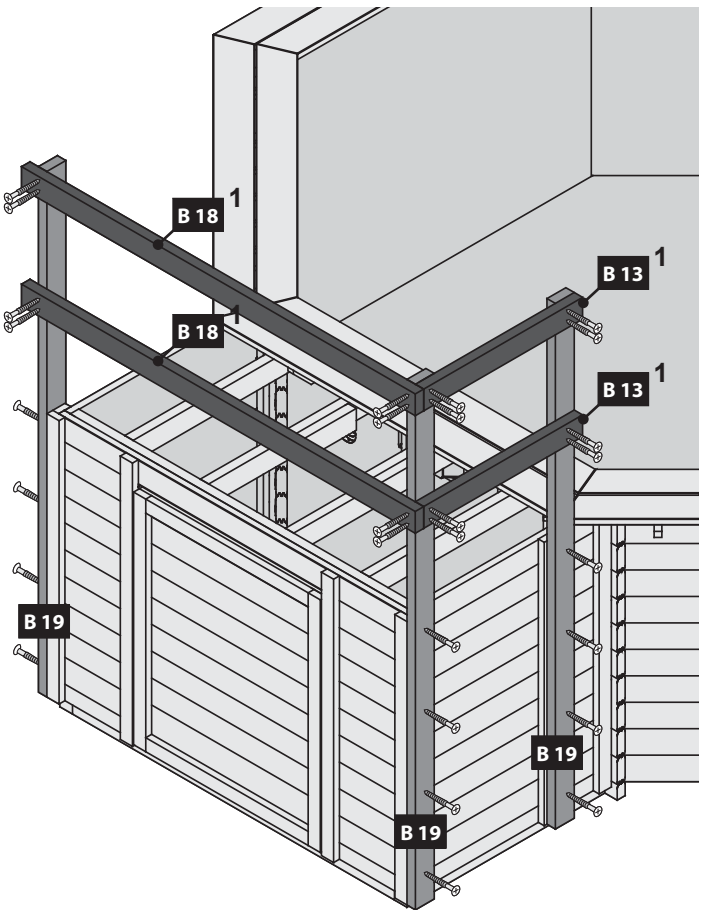

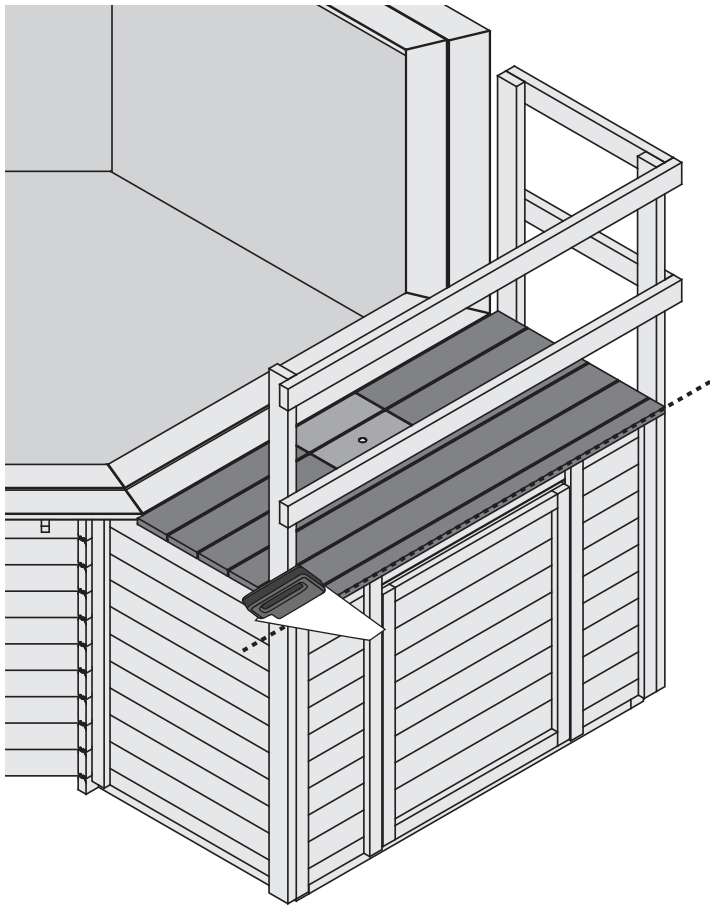

66x

Ø3 mm 4x50

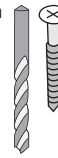

- | | |
|--|--|
|  Edelstahl |  rustfrit stål |
|  stainless steel |  acero inoxidable |
|  acier inoxydable |  acciaio inossidabile |
|  roestvrij staal |  nerez |

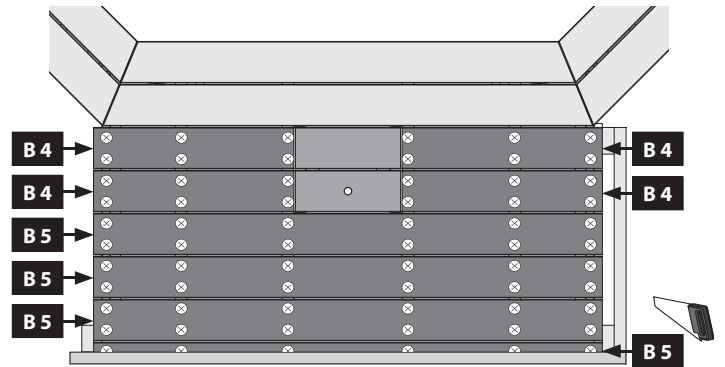

16x

Ø3 mm 4x50

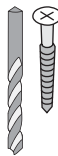

- | | |
|--|--|
|  Edelstahl |  rustfrit stål |
|  stainless steel |  acero inoxidable |
|  acier inoxydable |  acciaio inossidabile |
|  roestvrij staal |  nerez |

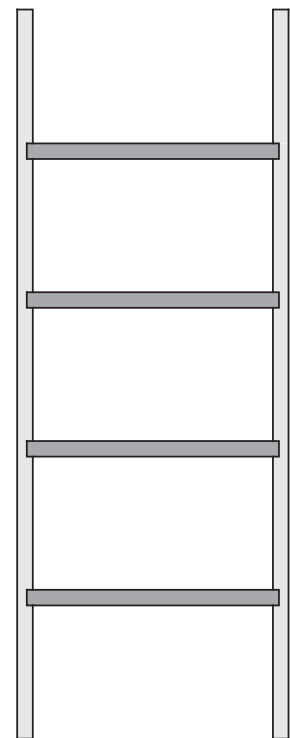
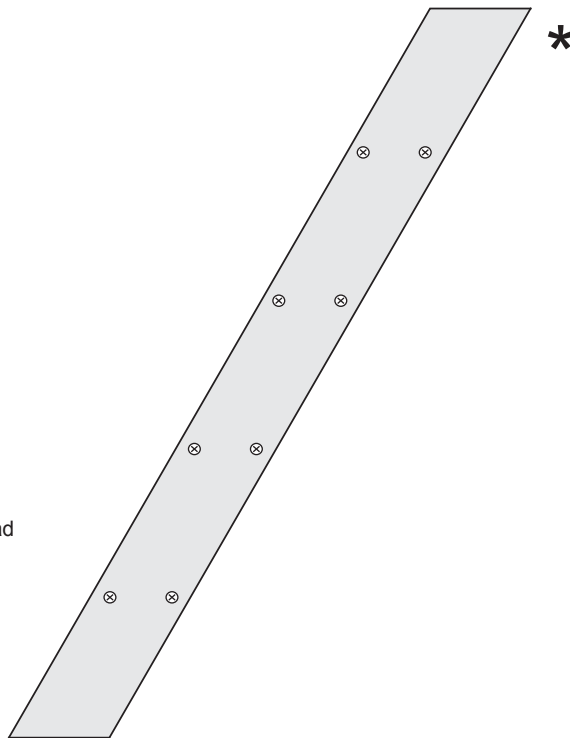

- | |
|--|
|  Bestand vom Pool |
|  Inventory of the pool |
|  Inventaire de la piscine |
|  Inventaris van het zwembad |
|  Beholdning af svømmepøl |
|  Inventario de la piscina |
|  Inventario della piscina |
|  Inventář bazén |

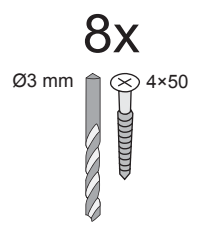
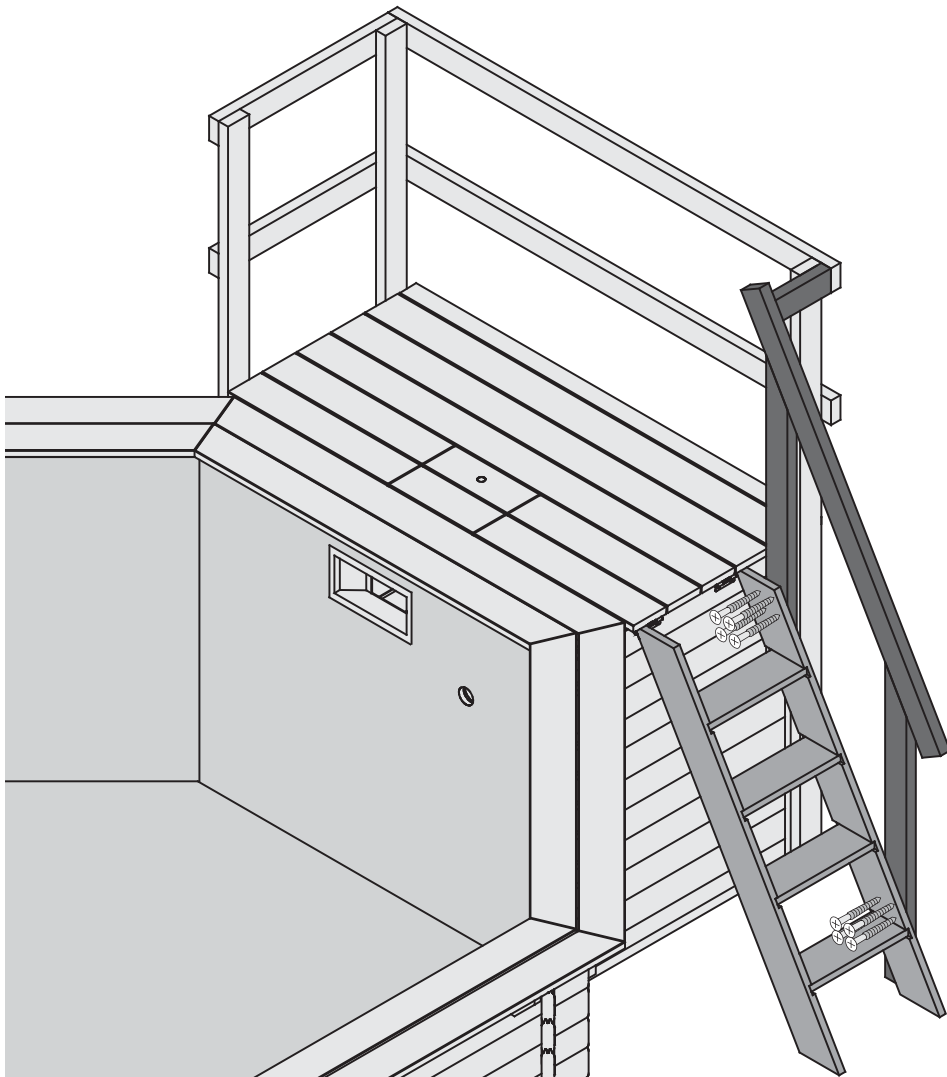
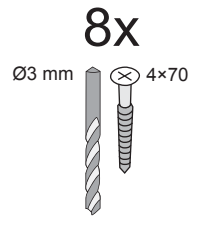
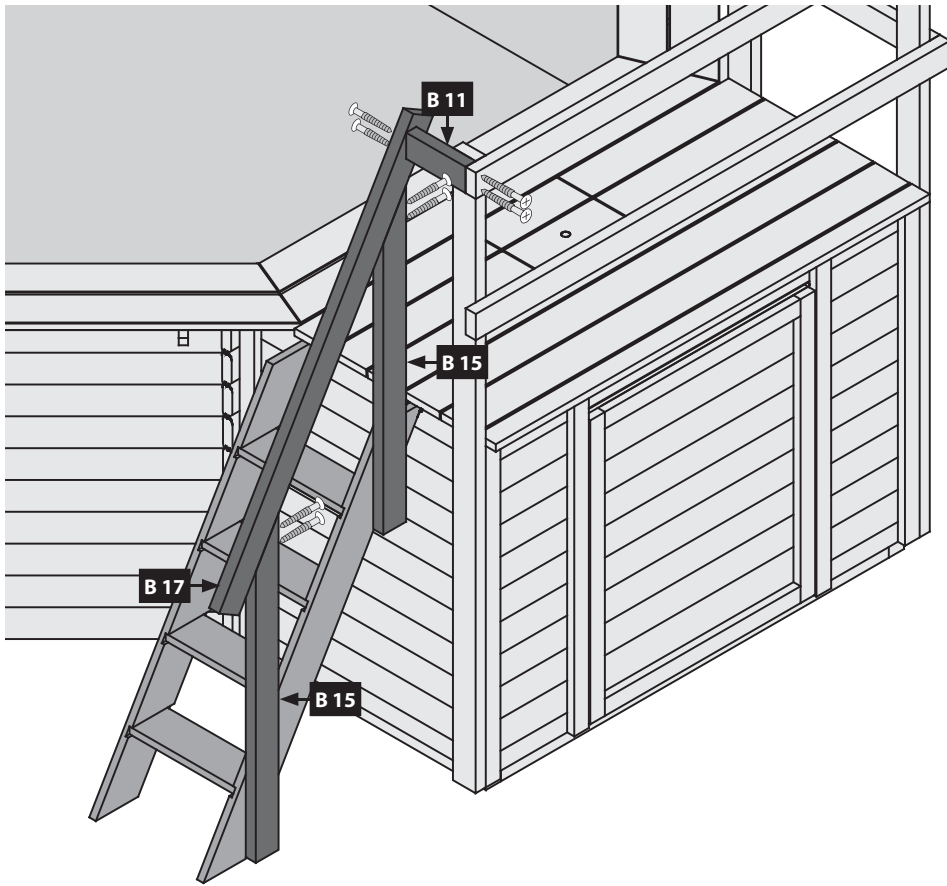

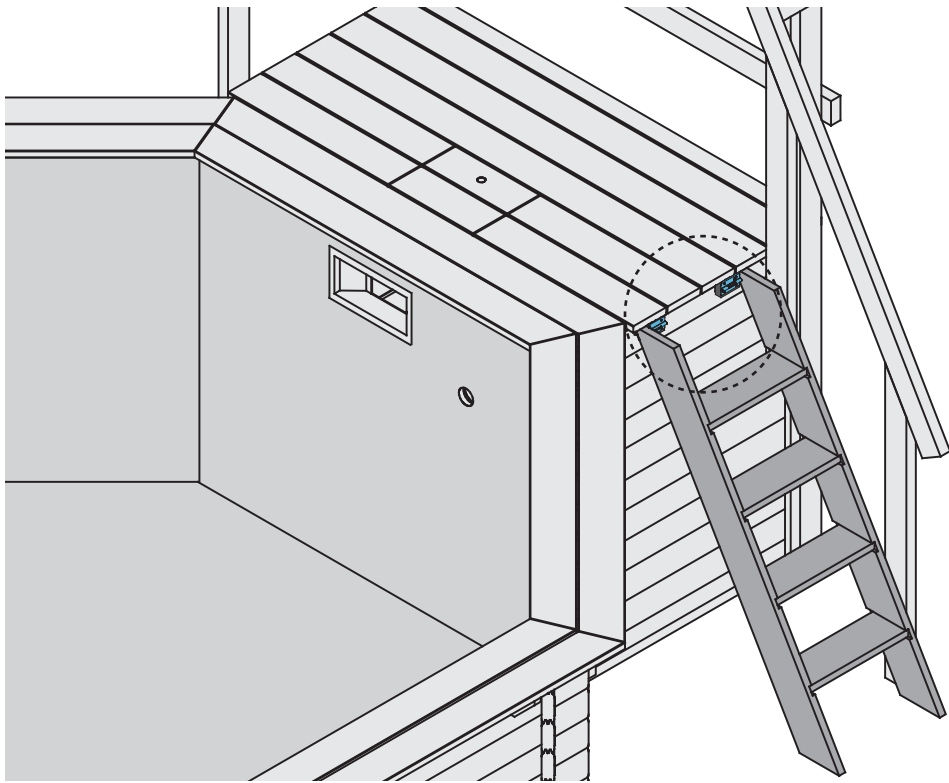

2x

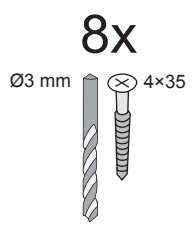
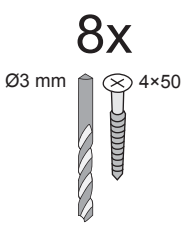
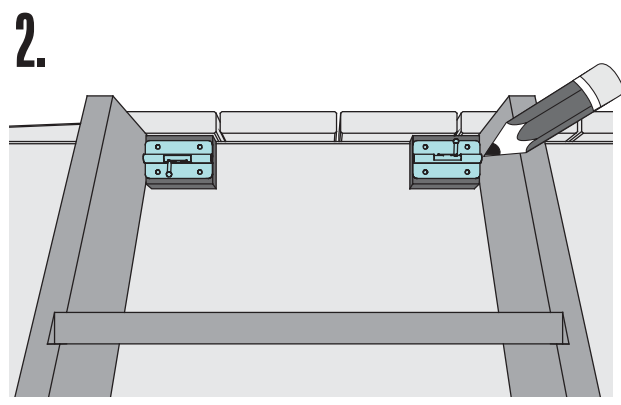
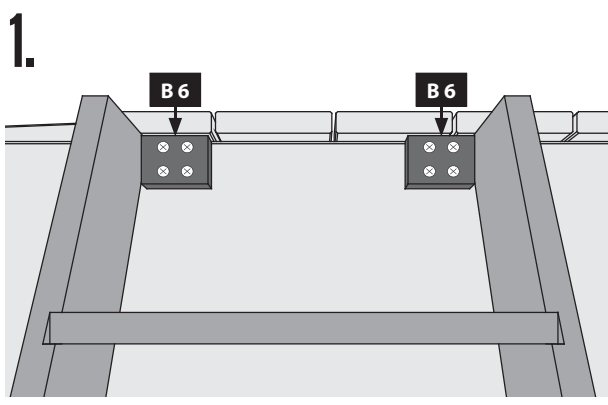
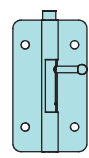

-  Edelstahl
-  stainless steel
-  acier inoxydable
-  roestvrij staal
-  rustfrit stål
-  acero inoxidable
-  acciaio inossidabile
-  nerez

