

18 mm



PROD.Nr.:

GARTEN Q 415 (1515 18 F1R0B1)
Art.Nr. 41515151-G1815151
Ean.Nr.:4004581526788





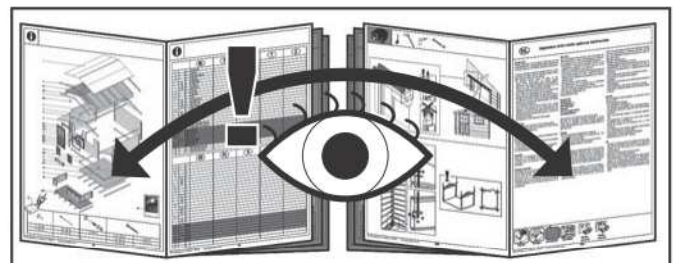



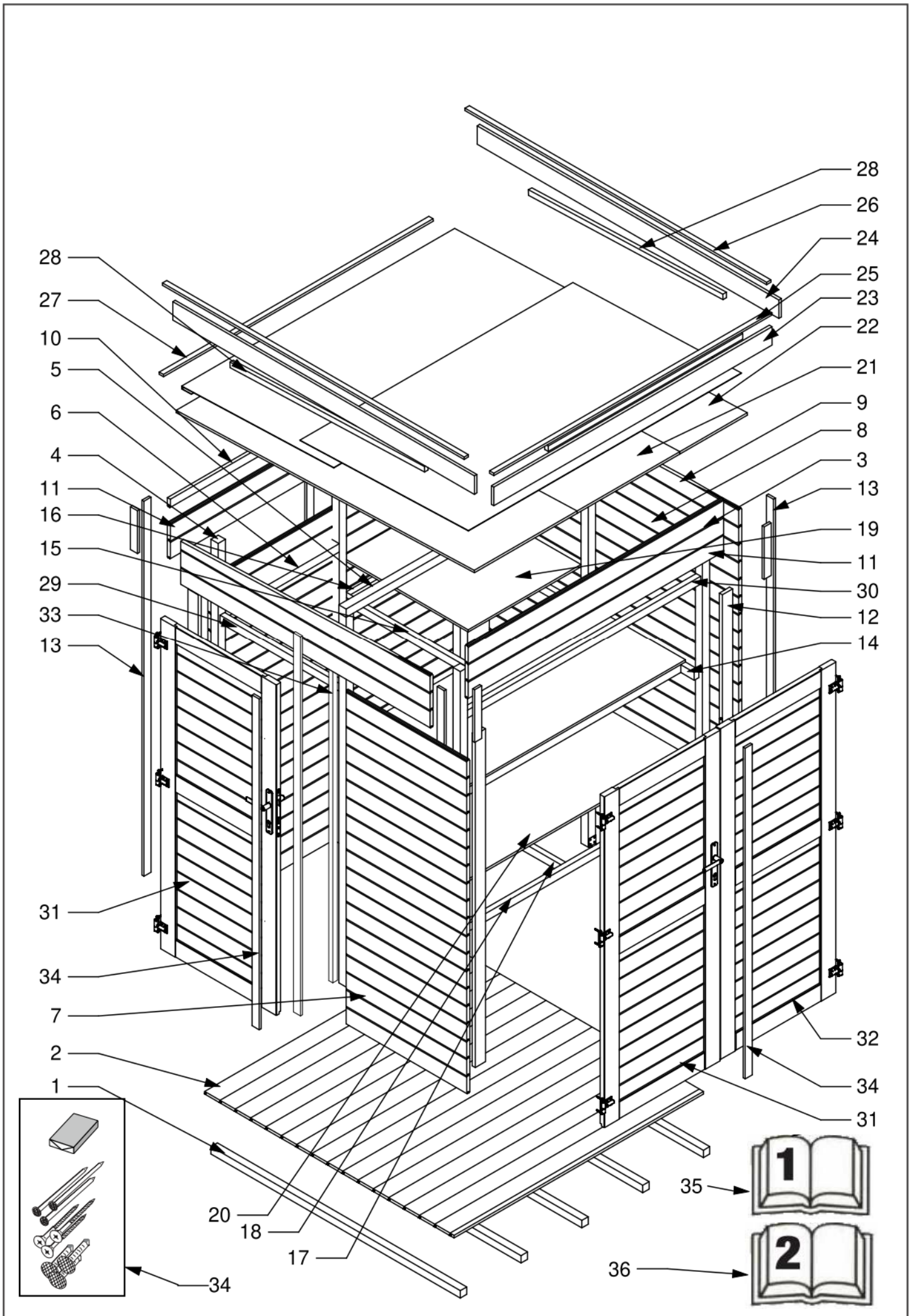



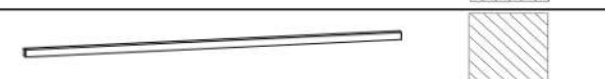

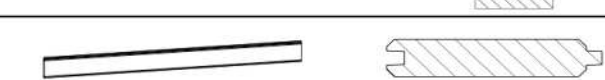

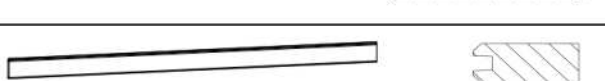
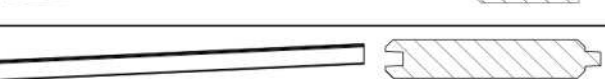
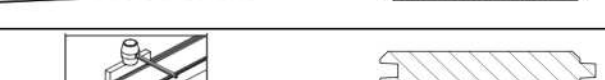



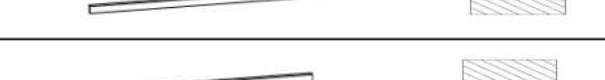

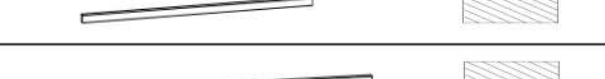

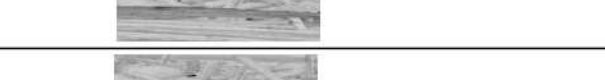















Hout voor Outdoor Life Products blokhutten en tuinhuizen is vooral afkomstig uit gecertificeerde en goed beheerde bossen.
Wood used for our Outdoor Life Products cabins and garden houses is mostly sourced from certified and well-managed forests.
Das Holz für Outdoor Life Products Blockbohlenhäuser und Gartenhäuser wird größtenteils aus zertifizierten Wäldern bezogen.
Les bois pour chalets et maisons de jardin de Outdoor Life Products proviennent en grande partie de forêts certifiées et gérées durablement.

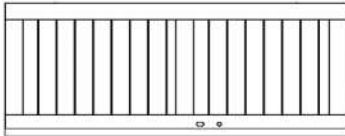
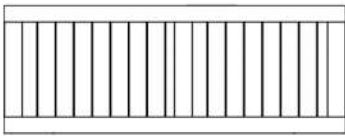













www.weka-holzbau.com, info@weka-holzbau.com
WEKA Holzbau GmbH DE-17013 Neubrandenburg

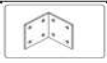

1.	G38381480		38x38x1480	5X
2.	G13991480		13,5x99x1480	17X
3.	G43431960		43x43x1960	2X
4.	G43431903		43x43x1903	5X
5.	G43431480		43x43x1480	1X
6.	G4343675		43x43x675	1X
7.	G1898716		18x98x716	19X
8.	G18981480		18x98x1480	42X
9.	G18981480S		18x98x1480	2X
10.	G18451516		18x45x1516N	1X
11.	G18981516		18x98x1516	5X
	G5157074		18X98X716	2X
12.	G18611710		18x61x1710	3X
13.	G2222473		12x42x1950	9X
14.	G2740700		27,6x40x700	4X
15.	G2740750		27,6x40x750	2X
16.	G2740617		27,6x40x617	2X
17.	G2740564		27,6x40x564	2X
18.	G27401338		27,6x40x1338	4X
19.	G670750		12x670x750	1X
20.	G6201390		12x620x1390	2X
21.	G2224665		12x610x1770	2X
22.	G4001770		12x400x1770	1X
23.	G15951650		15x95x1650	1X
24.	G15951790		15x95x1790	2X
25.	G60147540-1650		12x26x1650	1X

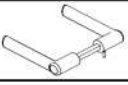
26.	G60147540-1780			12X26X1780	2X
27.	G60147540-1600			12x26x1600	1X
28.	G2227417			20,6x27,6x1155	3X
29.	G27406721			27,6x40x721	1X
30.	G27401394			27,6x40x1394	1X
31.	G6881699Z			Lap 688x1699_NP_Z (HP2153)	2X
32.	G6881699Ü			Lap 688x1699_NP_Ü (HP2181)	1X
33.	G24271690			24x27x1690 NP zárlec	1X
34.	G2222672			12x42x1699	2X
35.	G2230436			KellCs. Szekrény 1515	1X
36.	G6099908		Building instr.	Útm. Építési	1X
37.	G6065190		General Conditions	Útm. Általános	1X

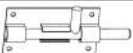
G2230436

a	G60146097		3,5x25 mm	85X
b	G60146066		4x25 mm	36X
c	G60124056		3,5x35 mm	560X
d	G60146093		4,0x60 mm	35X
e	G60146094		5,0x80 mm	8X
f	G60146117		40x40x40	13X
g	G682368			9X
h	G688162		Zár MIDI7 Cil+ütk.lem Horg.	2X
i	G682221		Cilinder 62 mm	2X
j	G688254K		Kilincs 410 F1	2X
k	G688254C		Cím EL74/90 MIDI Cilinderes	2X
l	G60146052		Tolózár 100 mm bajonett	2X
m	G601994320		SzegCs.22x50 (200X)	1X

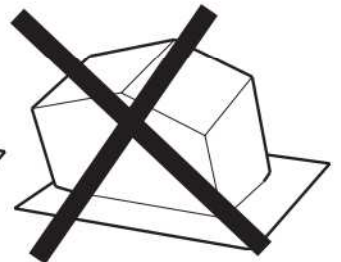
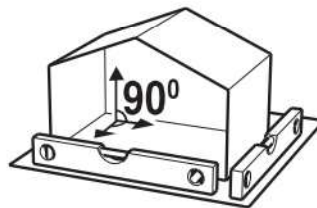
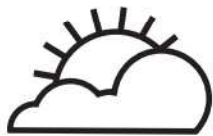
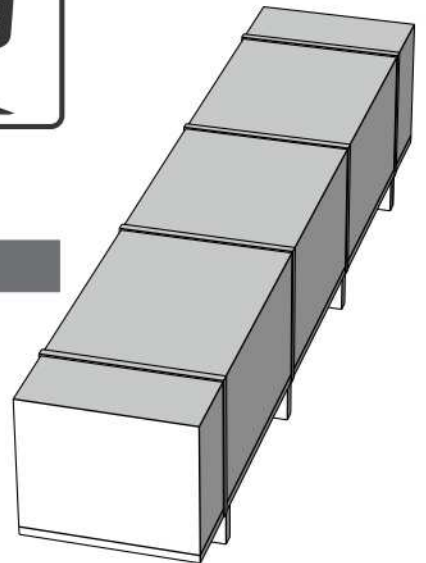
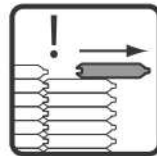
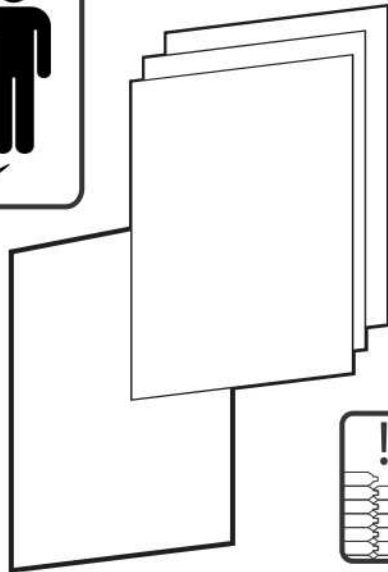
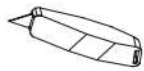
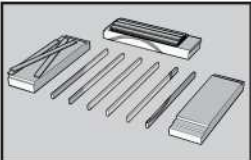

M10

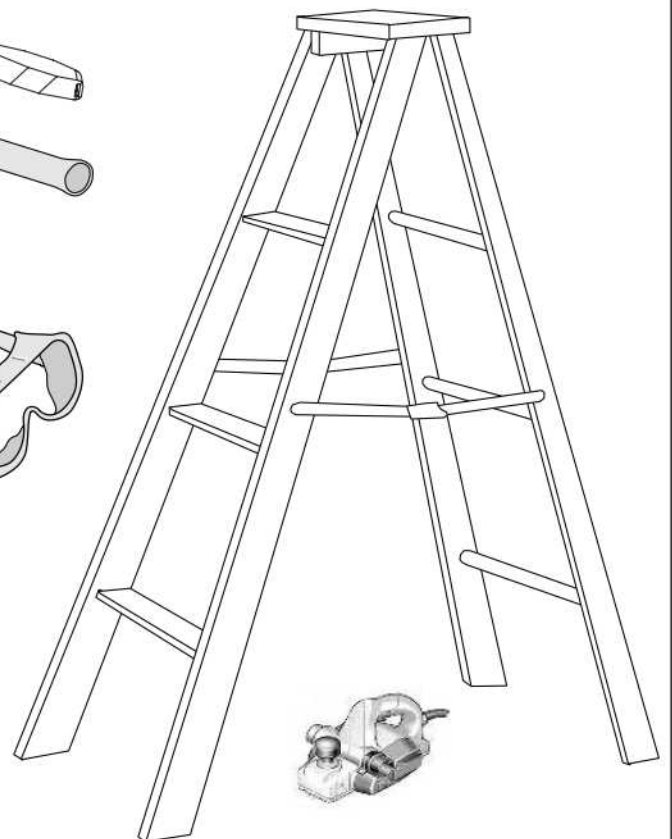
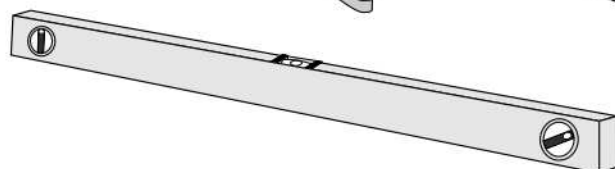
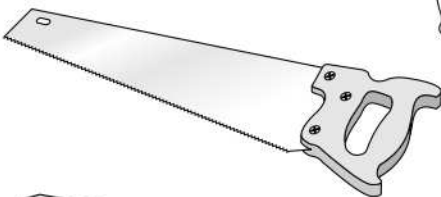
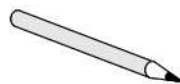
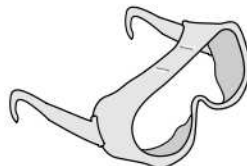
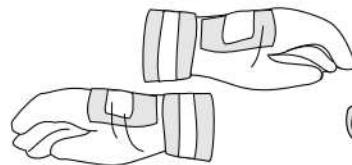
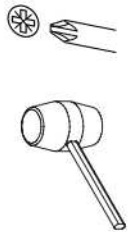
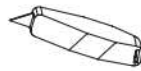
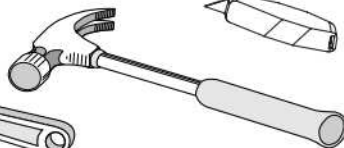
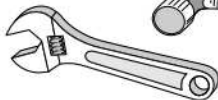
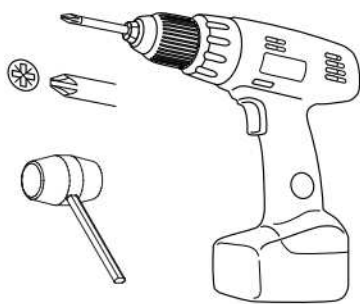

1

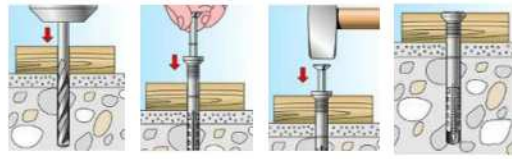
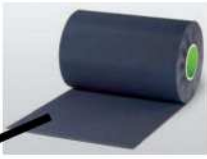
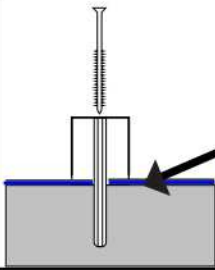

POS

1  38x38x1480 5X

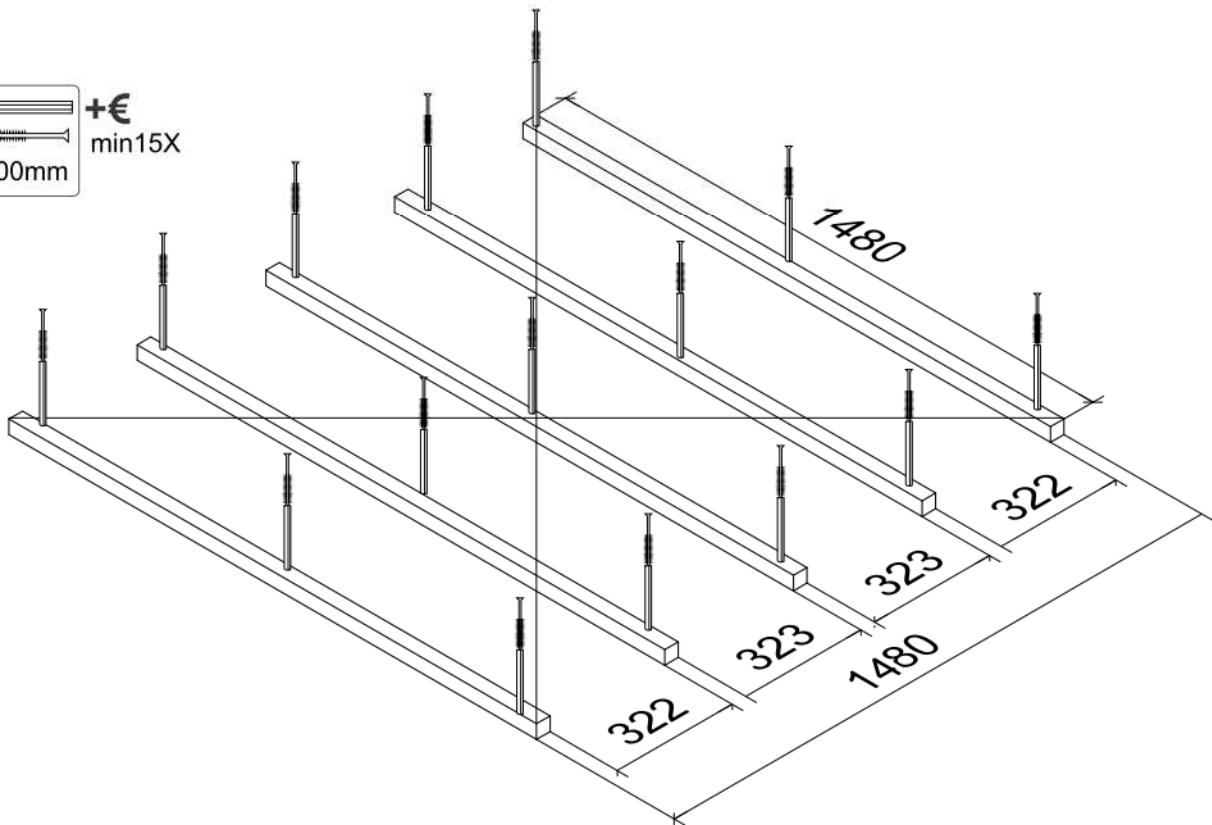
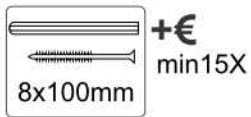
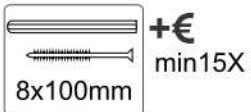

2

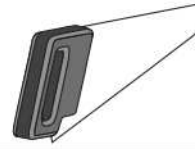

POS

2



13,5x99x1480 17X



170

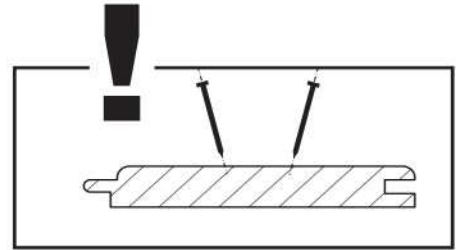

POS2

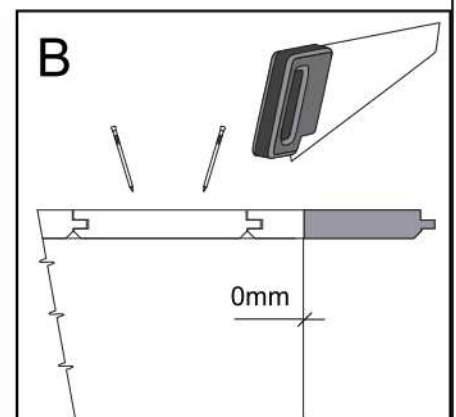
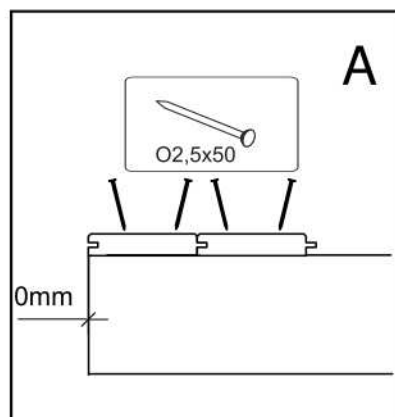
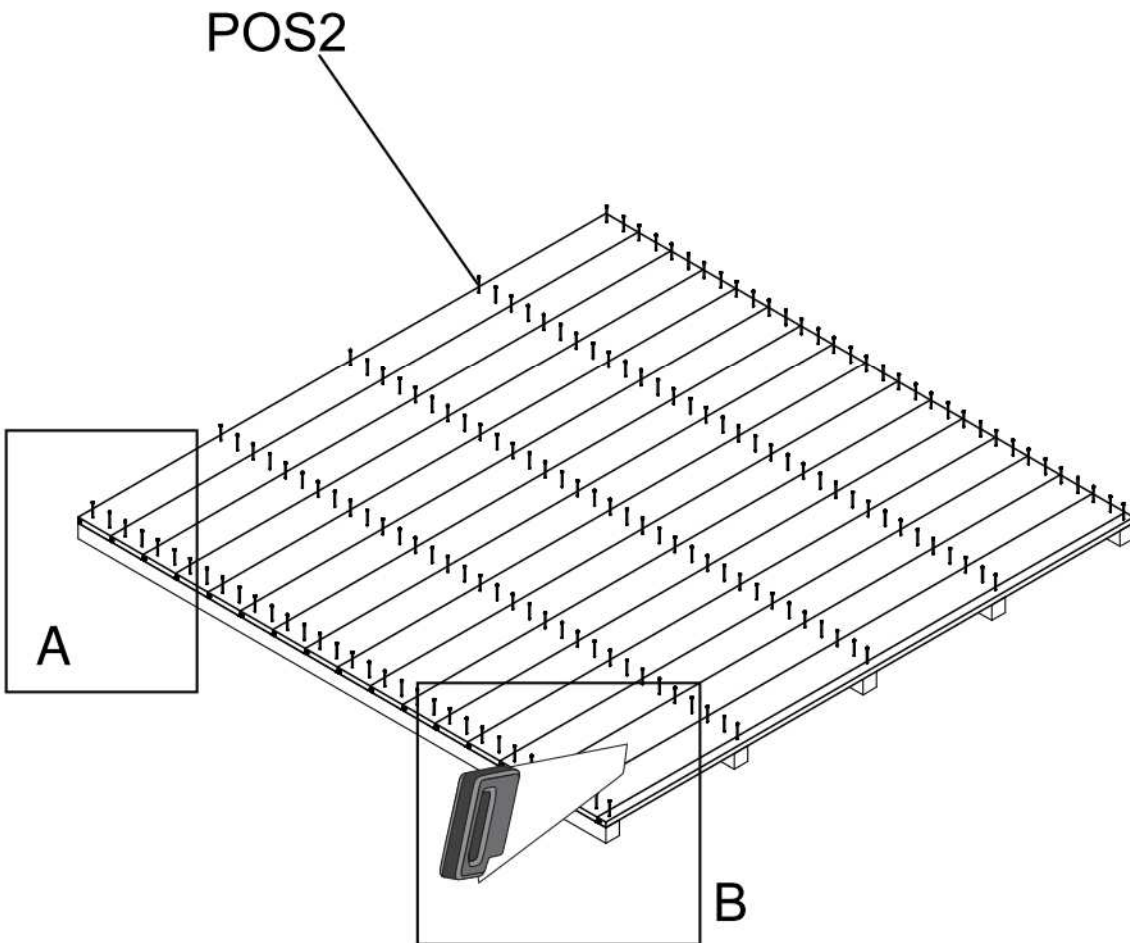

3

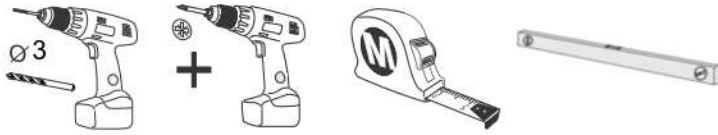

POS

3  43x43x1960 2X

4  43x43x1903 5X

 28X  7X

3,5x35mm

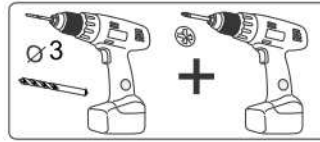

 3,5x35mm

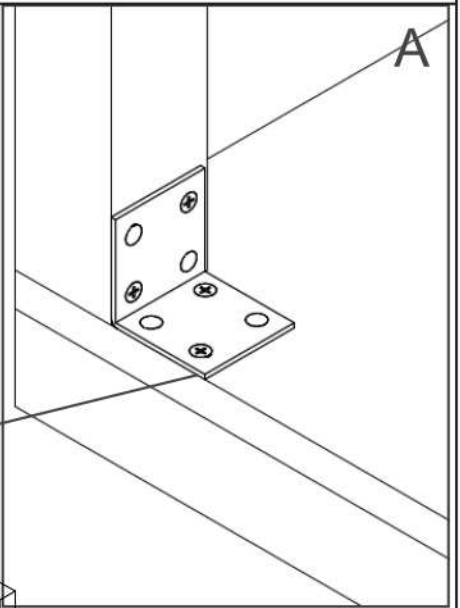

A

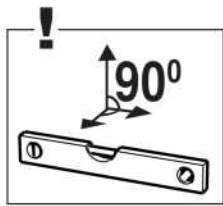

POS4

POS3

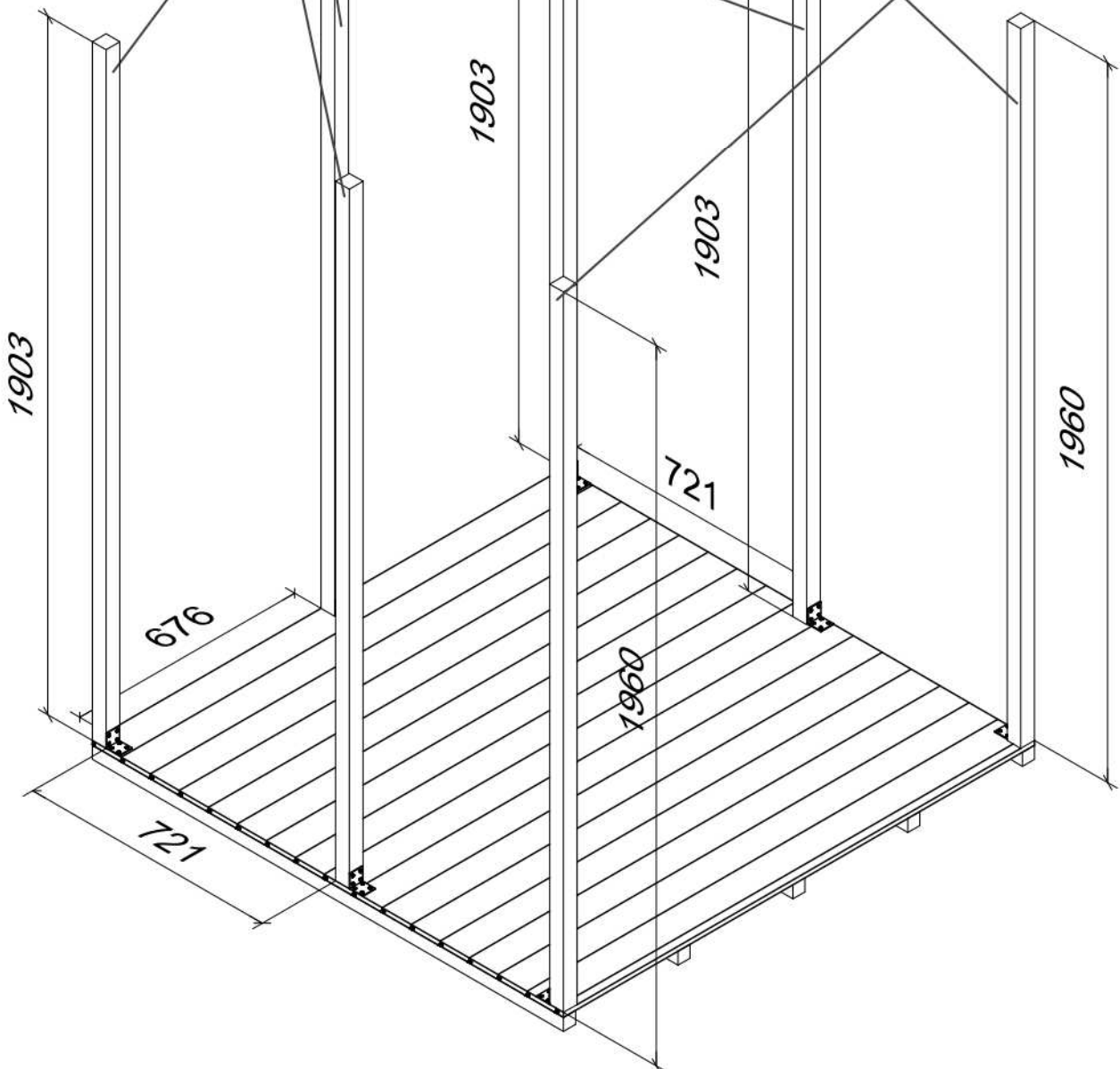

4

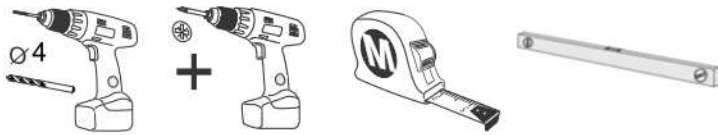

POS

5  43x43x1480 1X

6  43x43x675 1X

29  27,6x40x721 1X

30  27,6x40x1394 1X

 8X  6X

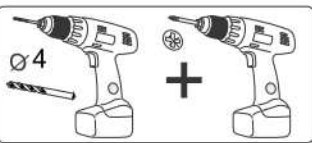
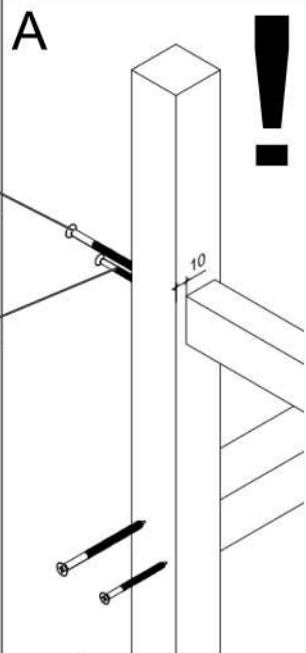
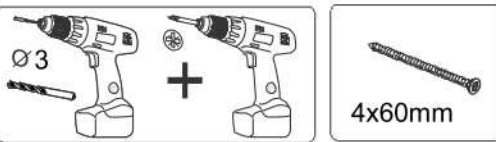
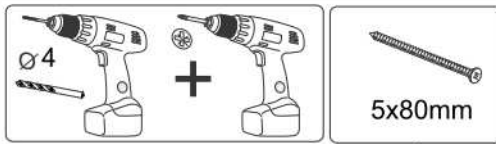

POS6

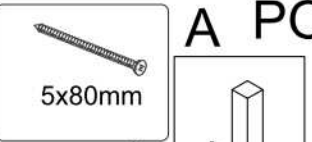

A POS29

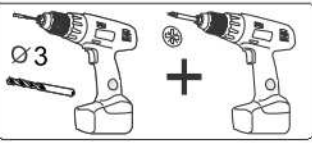
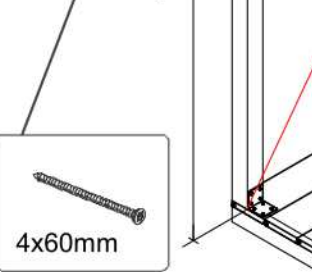
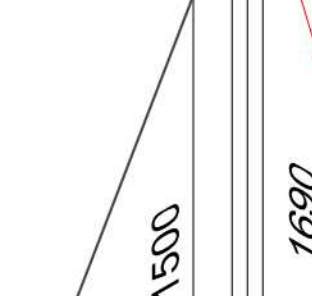
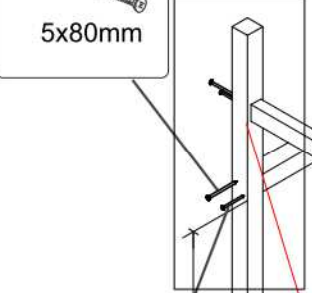

POS30

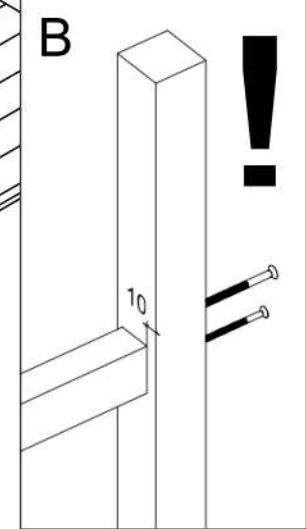
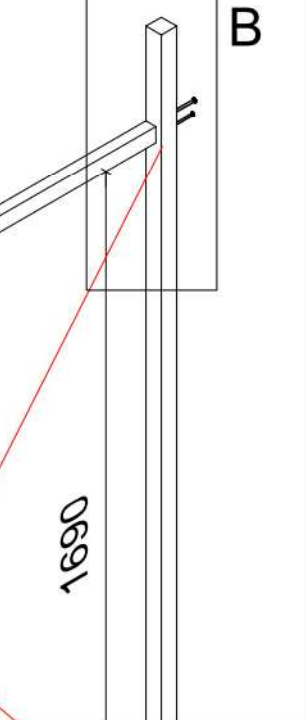
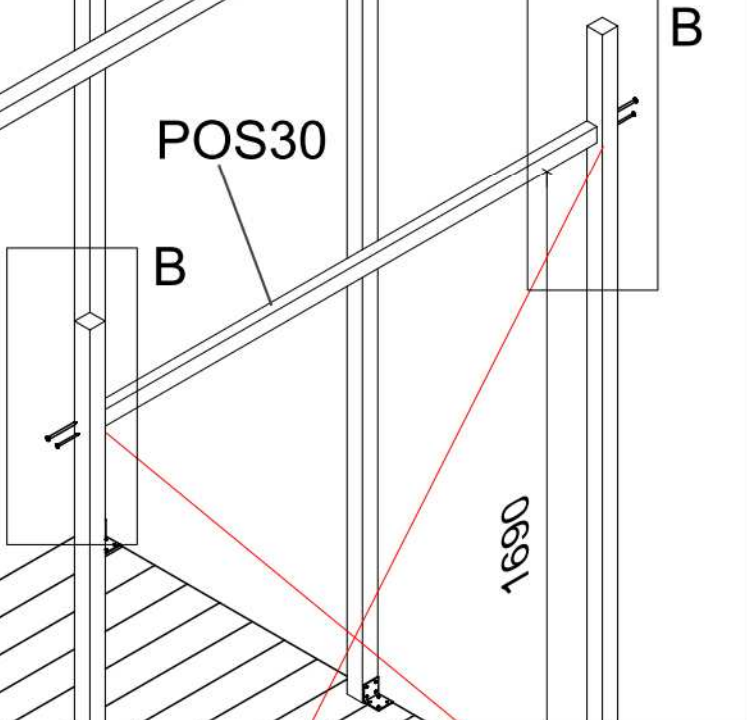

5

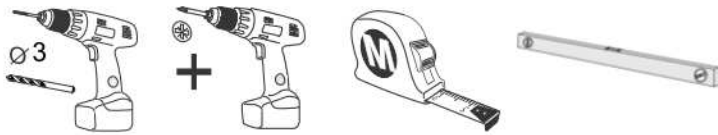

POS

7  18x98x716 1X

8  18x98x1480 2X

 16X
3,5x35mm

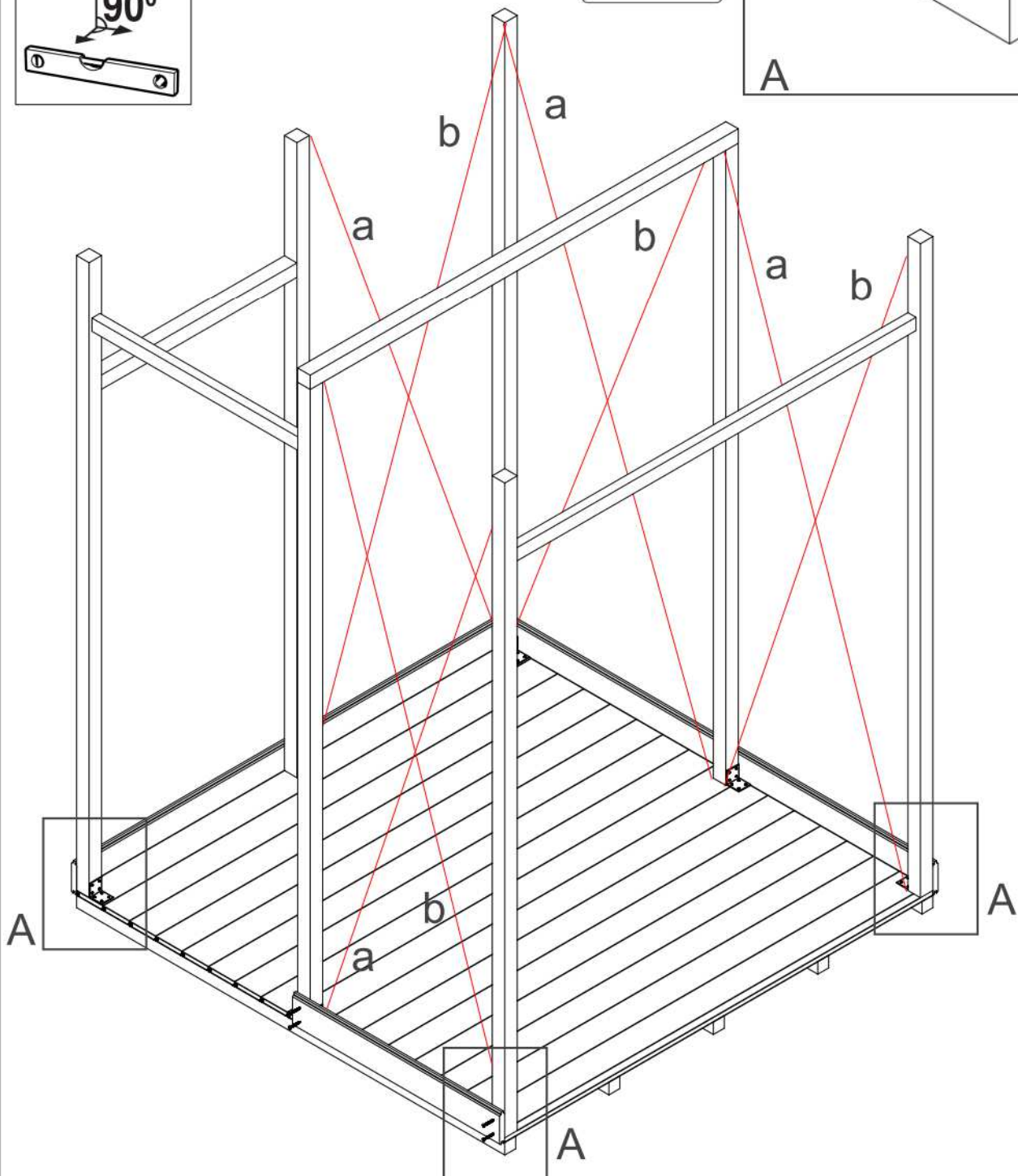
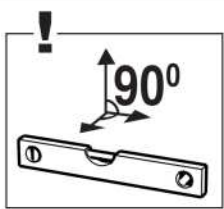
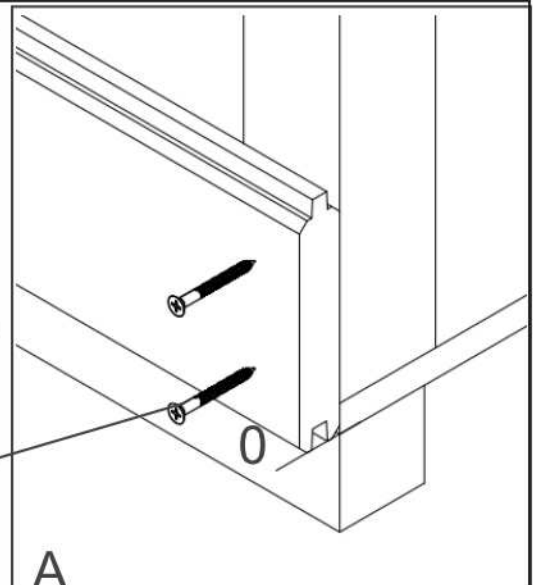
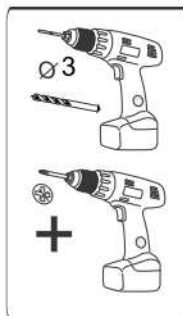

6

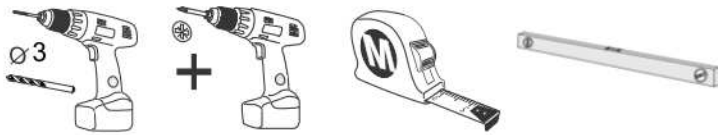

POS

11  18x98x1516 2X

8  18x98x1480 2X

12  18x61x1710 3X

33  24x27x1690 1X

 38X
3,5x35mm

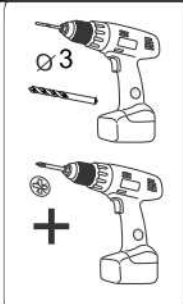

 3,5x35mm

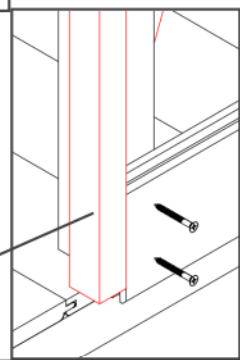
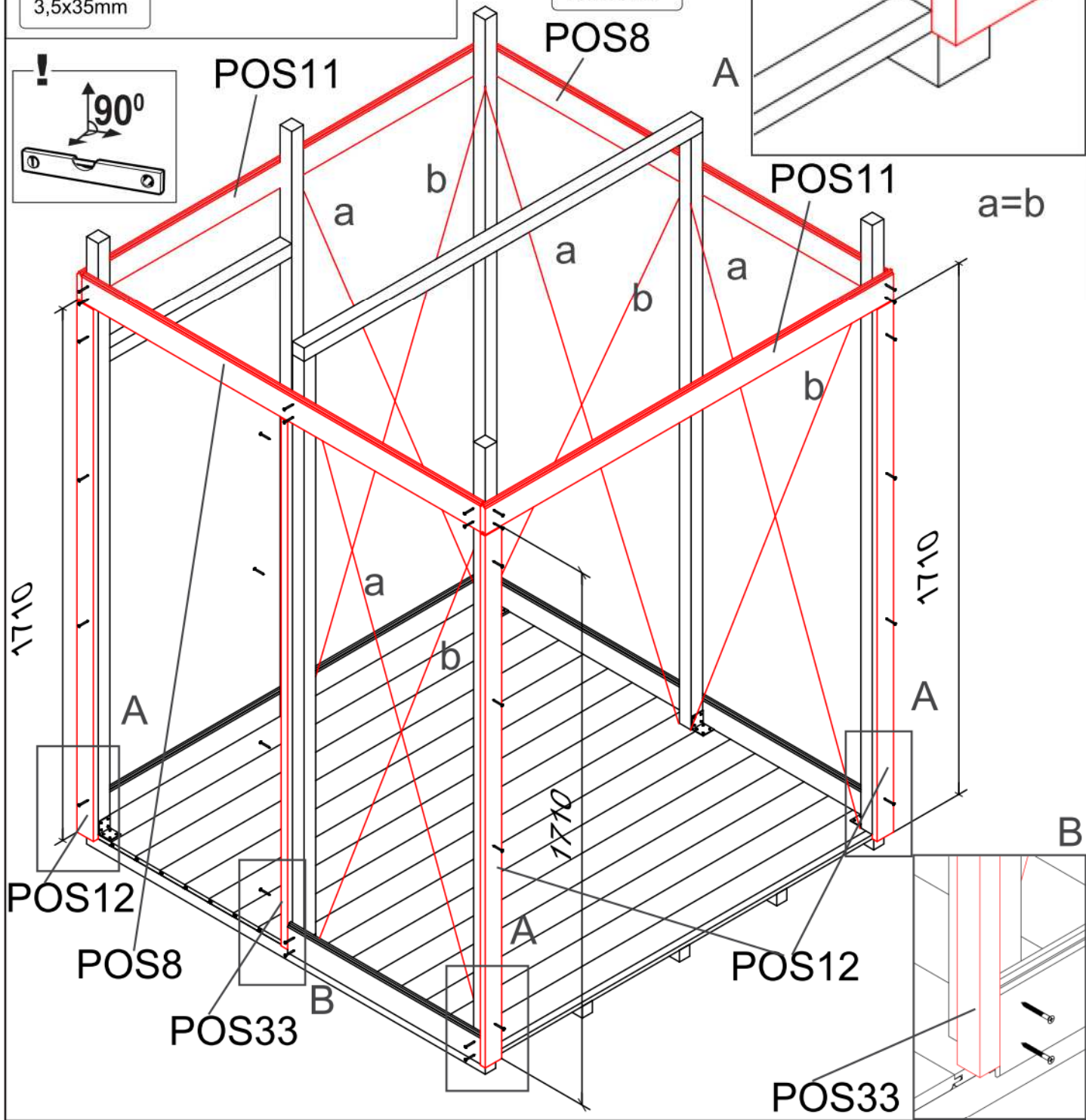
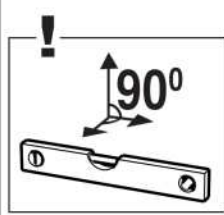
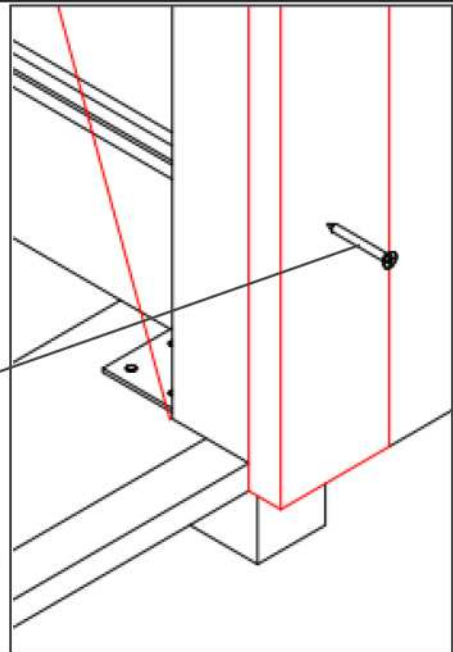

7

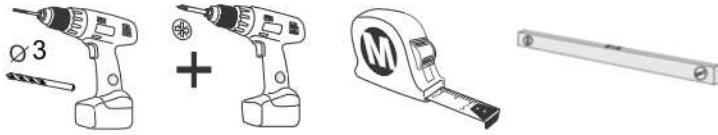

POS

7  18x98x716 4X

8  18x98x1480 8X

 64X
3,5x35mm

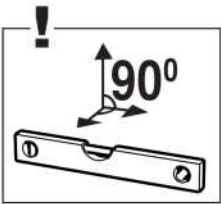
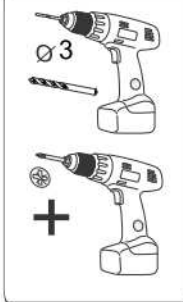

A

450

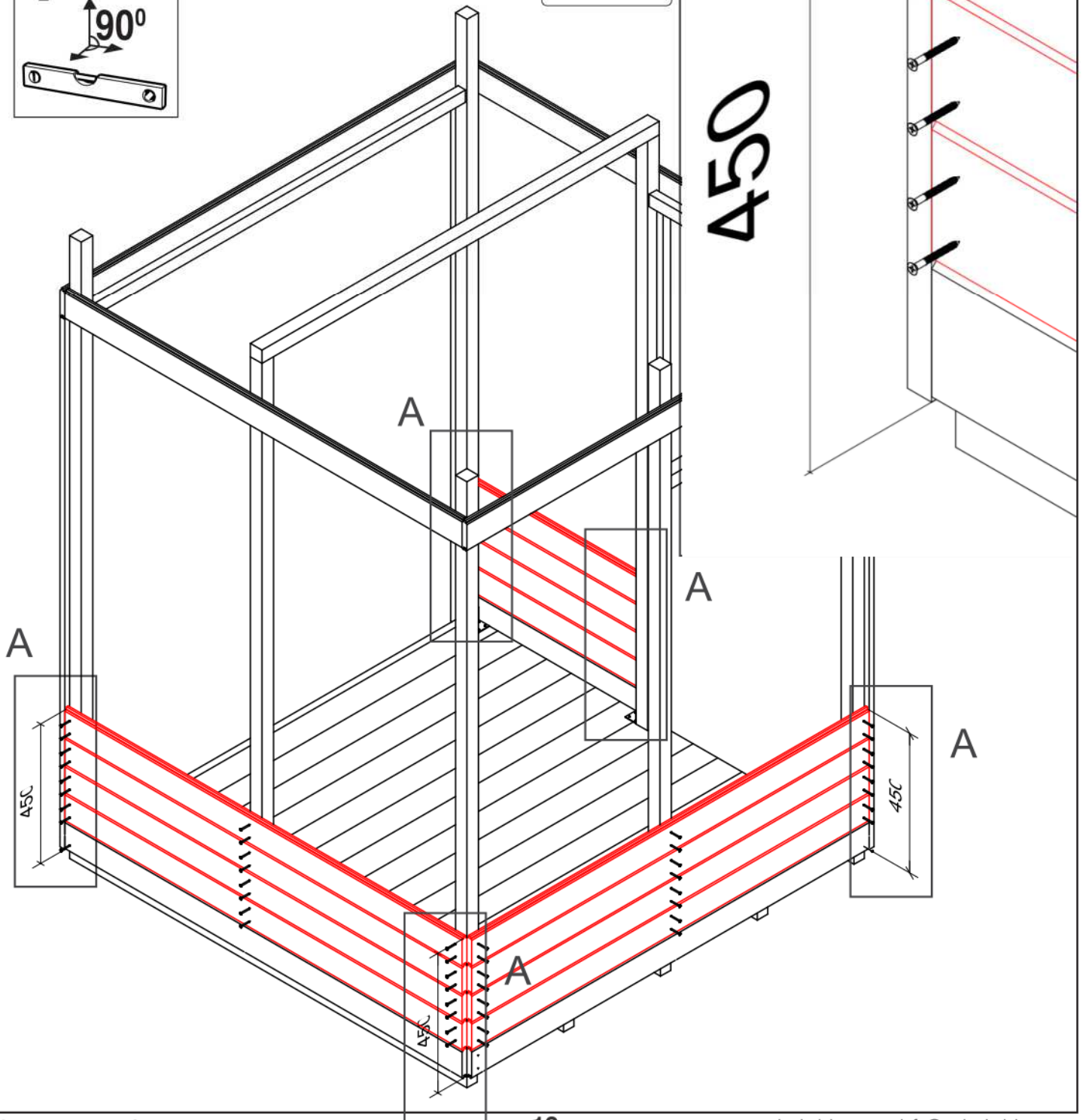

8

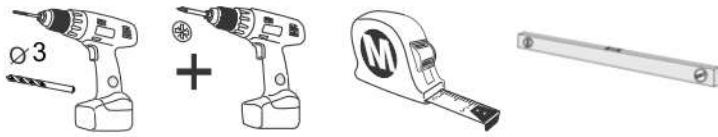



POS

15  27,6x40x750 2X

16  27,6x40x617 2X

19  12x670x750 1X

 4X

 8X

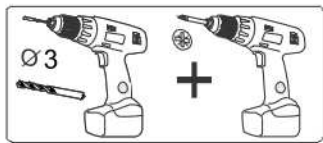
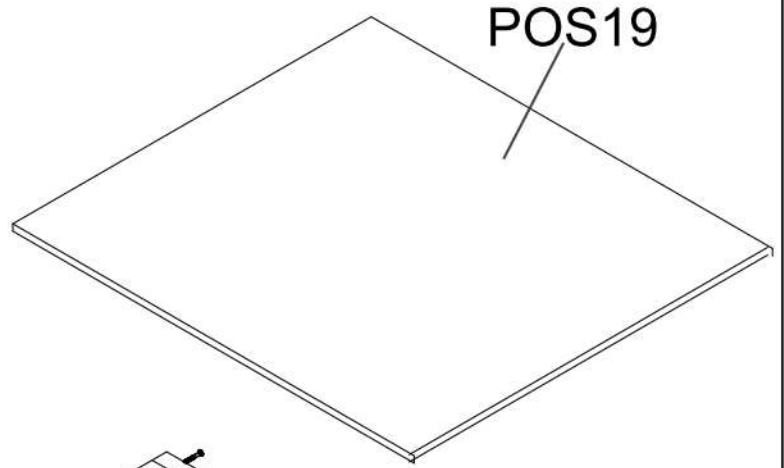

 4x60mm

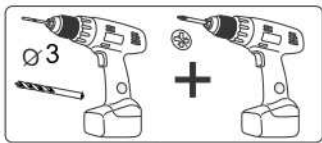
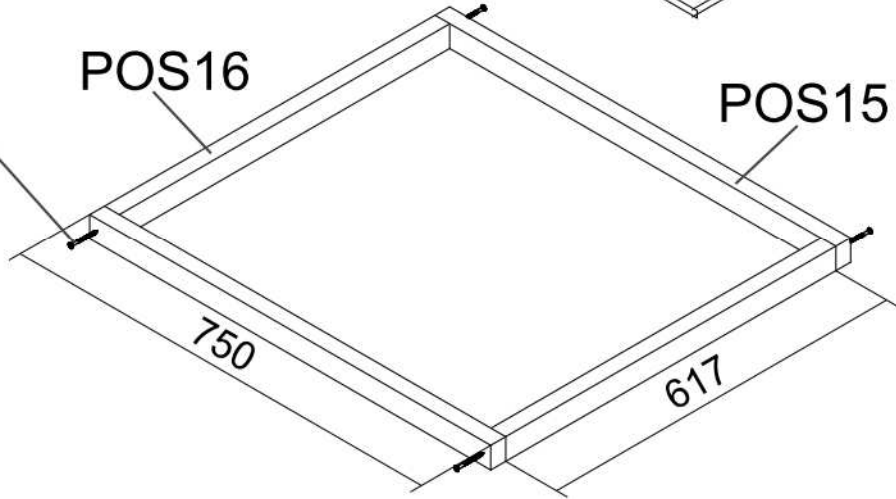



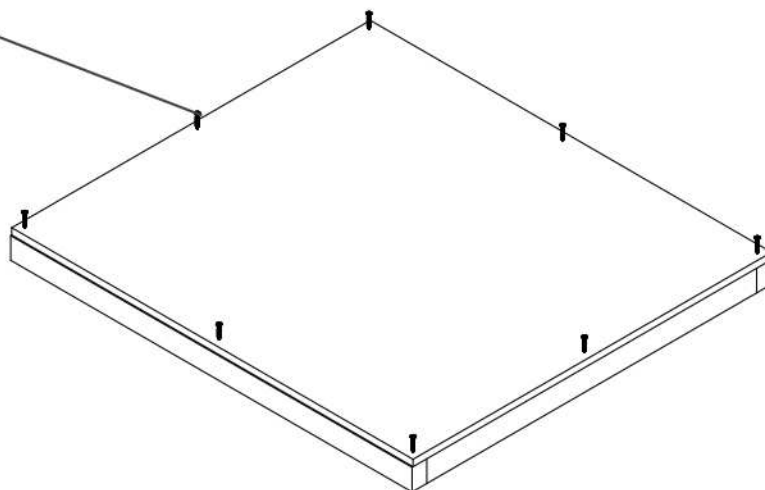

 3,5x25mm

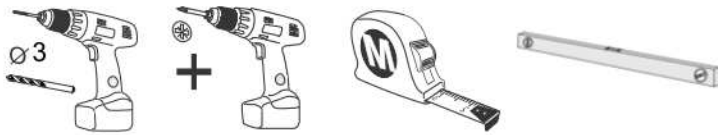



9



POS

- 14  27,6x40x700 4X
- 17  27,6x40x564 2X
- 18  27,6x40x1338 4X
- 20  12x620x1390 2X

	12X		26X
4x60mm		3,5x25mm	

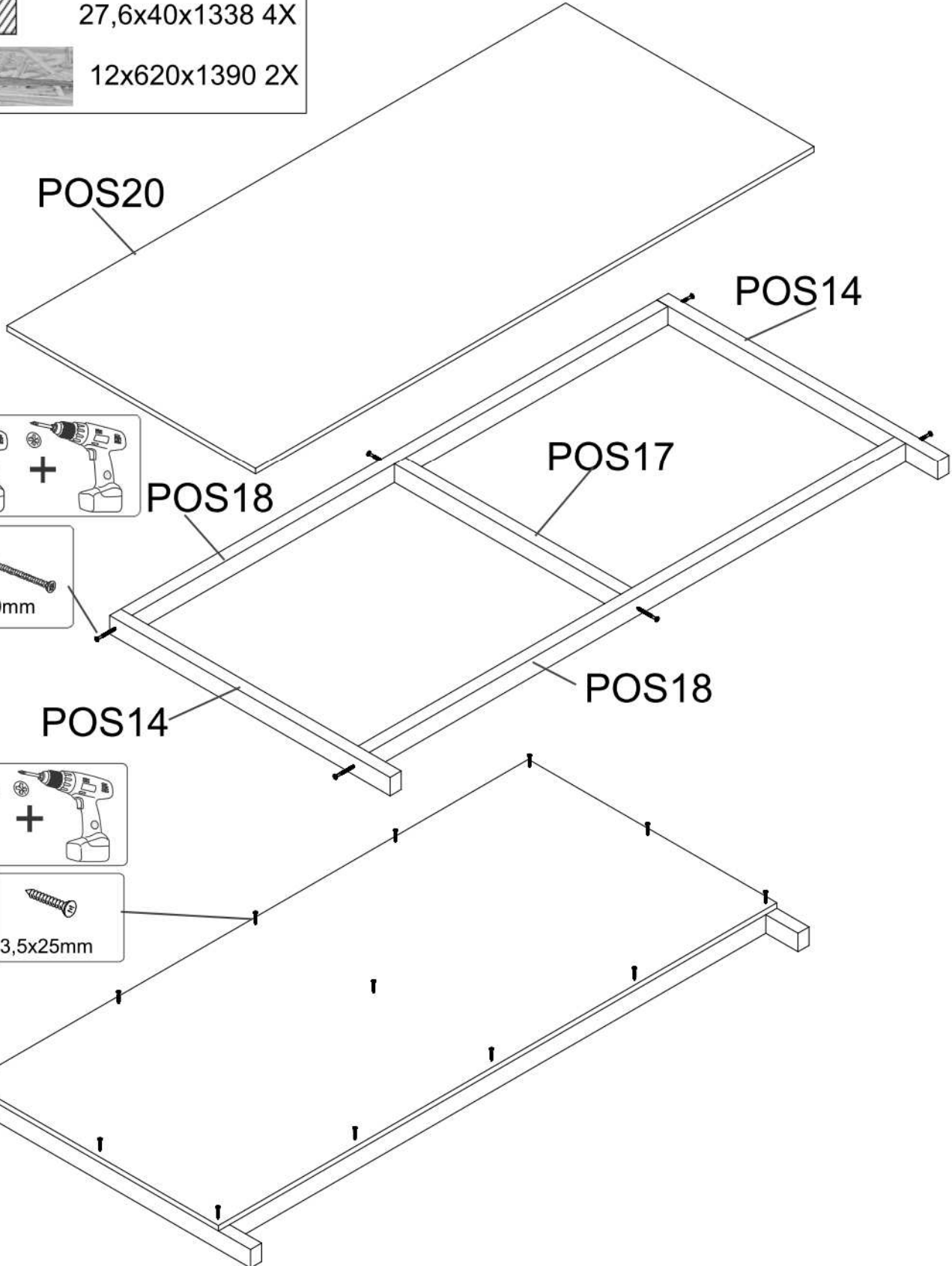

10



13X

4x60mm

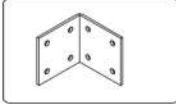

6X



28X

3,5x35mm

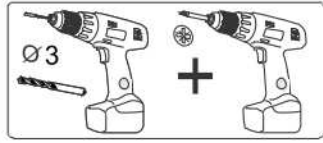

4x60mm

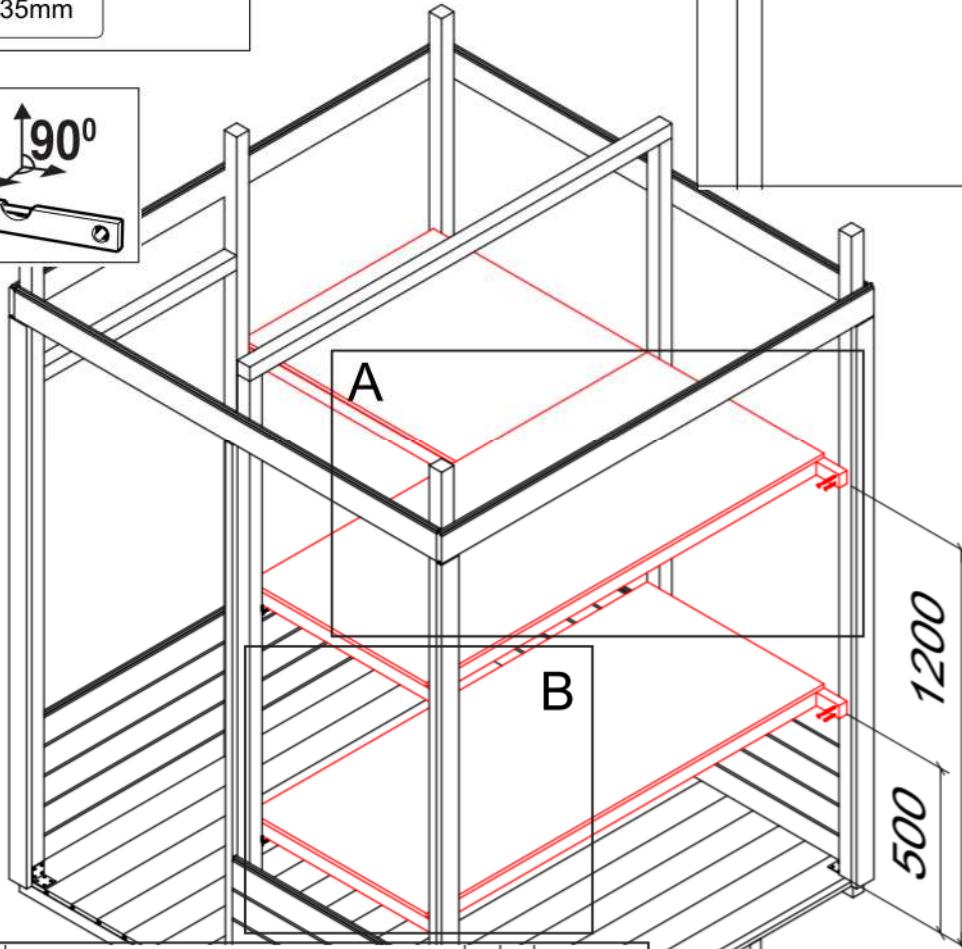
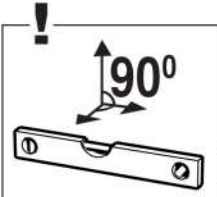
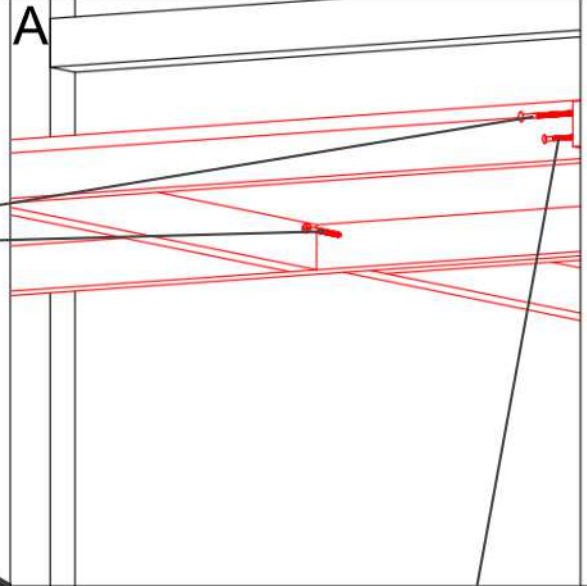

3,5x35mm

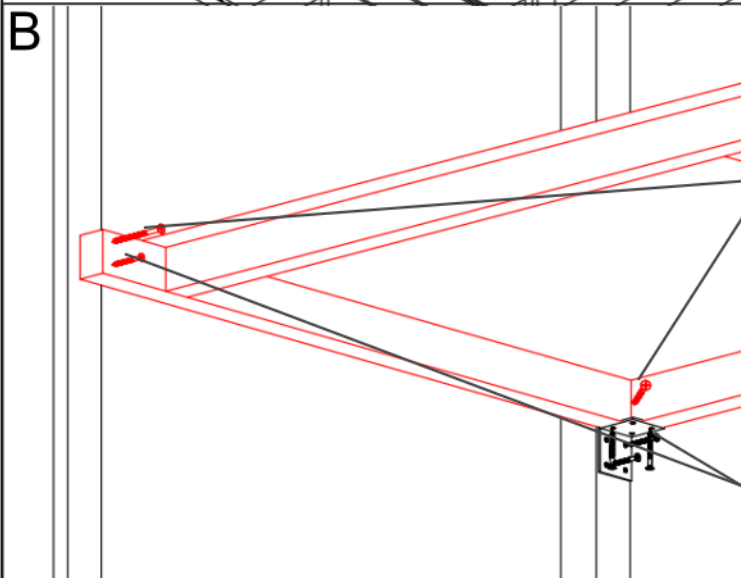
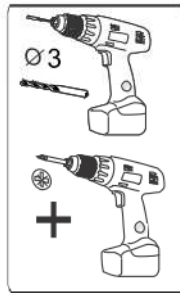

4x60mm

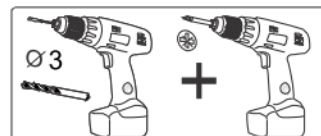

3,5x35mm

11

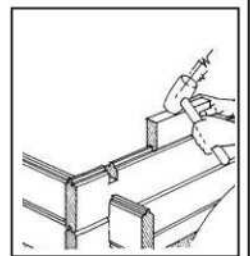
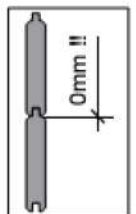
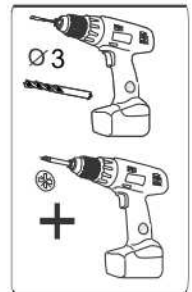
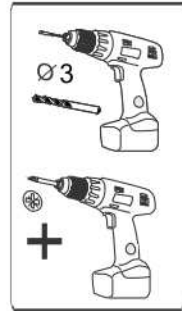
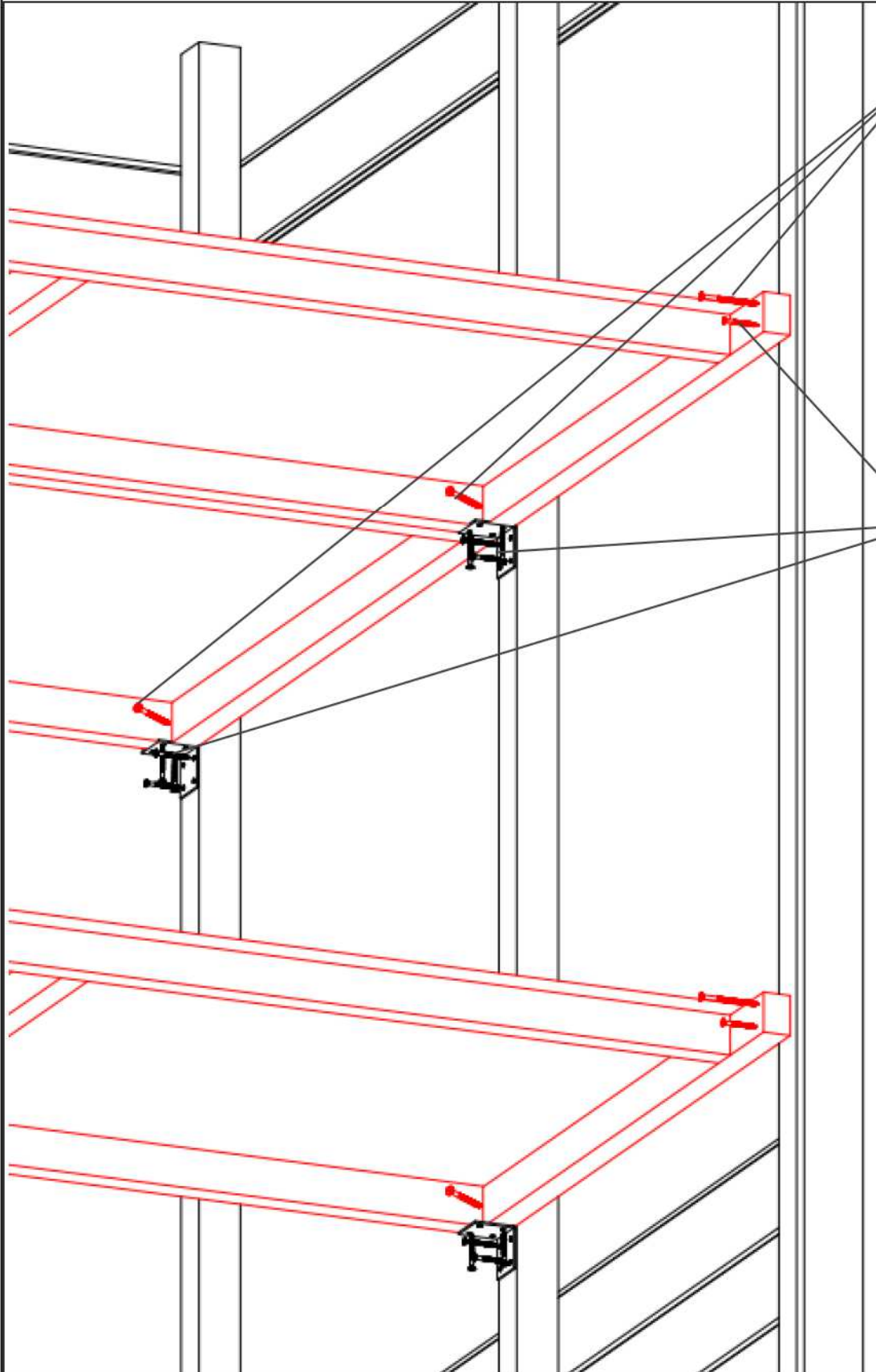
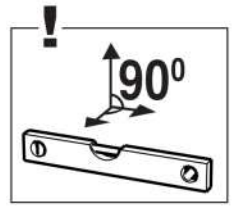

12

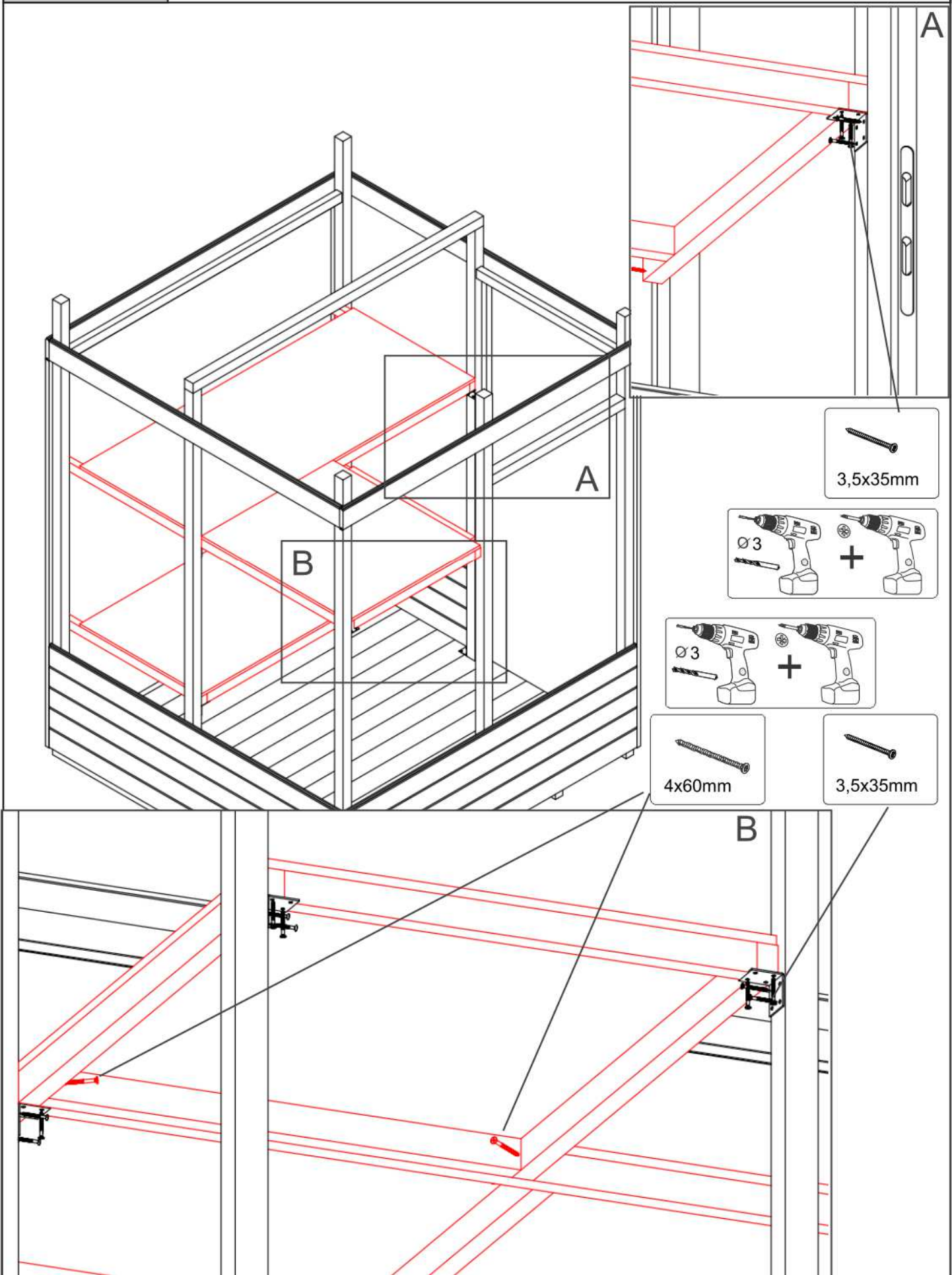

A

A

B

B

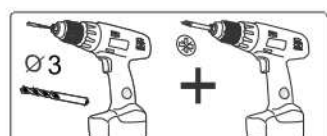

13

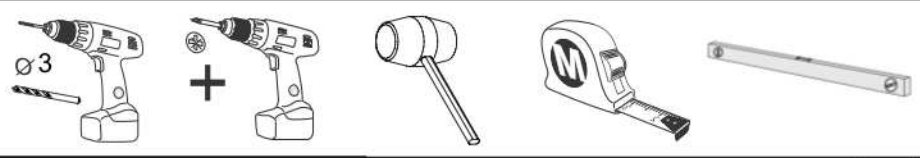

POS

7  18x98x716 5X

8  18x98x1480 10X



80X

3,5x35mm

A

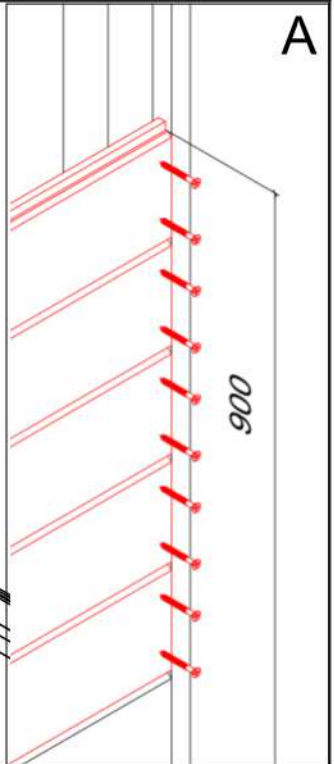

900

POS8

POS7

A

906

906

900



3,5x35mm

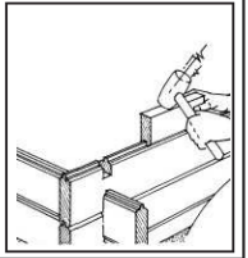
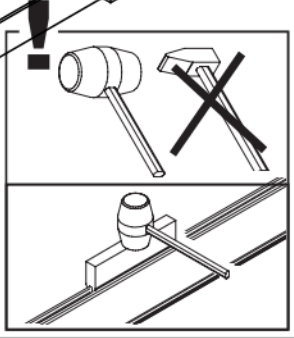
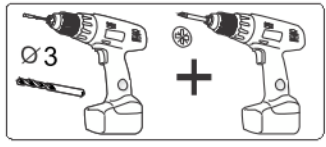

14



POS

7  18x98x716 9X



144X

8  18x98x1480 18X

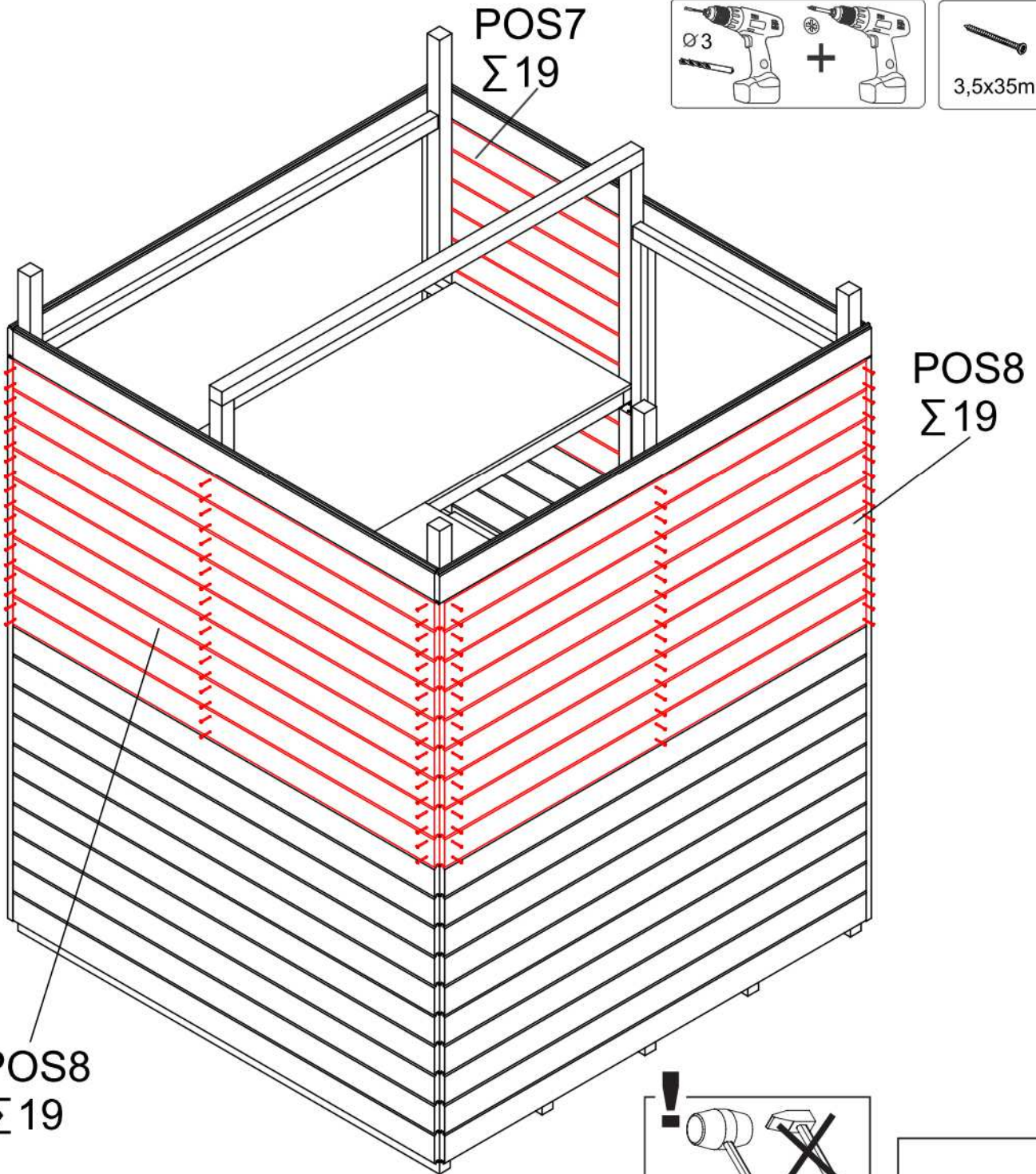

POS 8
Σ 19

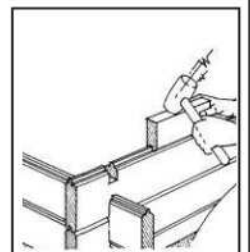
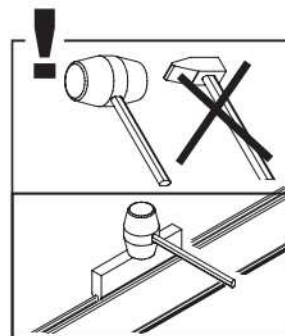

15

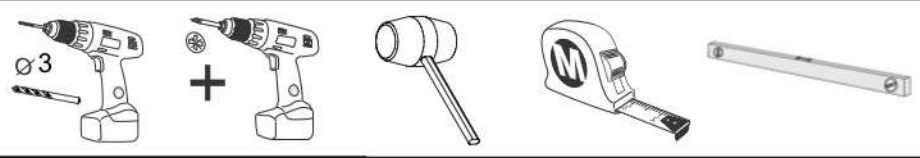

POS

11  18x98x1516 3X

8  18x98x1480 2X

 **48X**
3,5x35mm

POS11

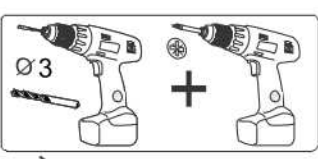
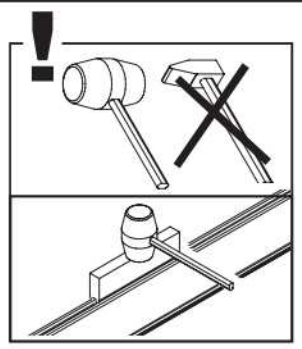

 3,5x35mm

POS8

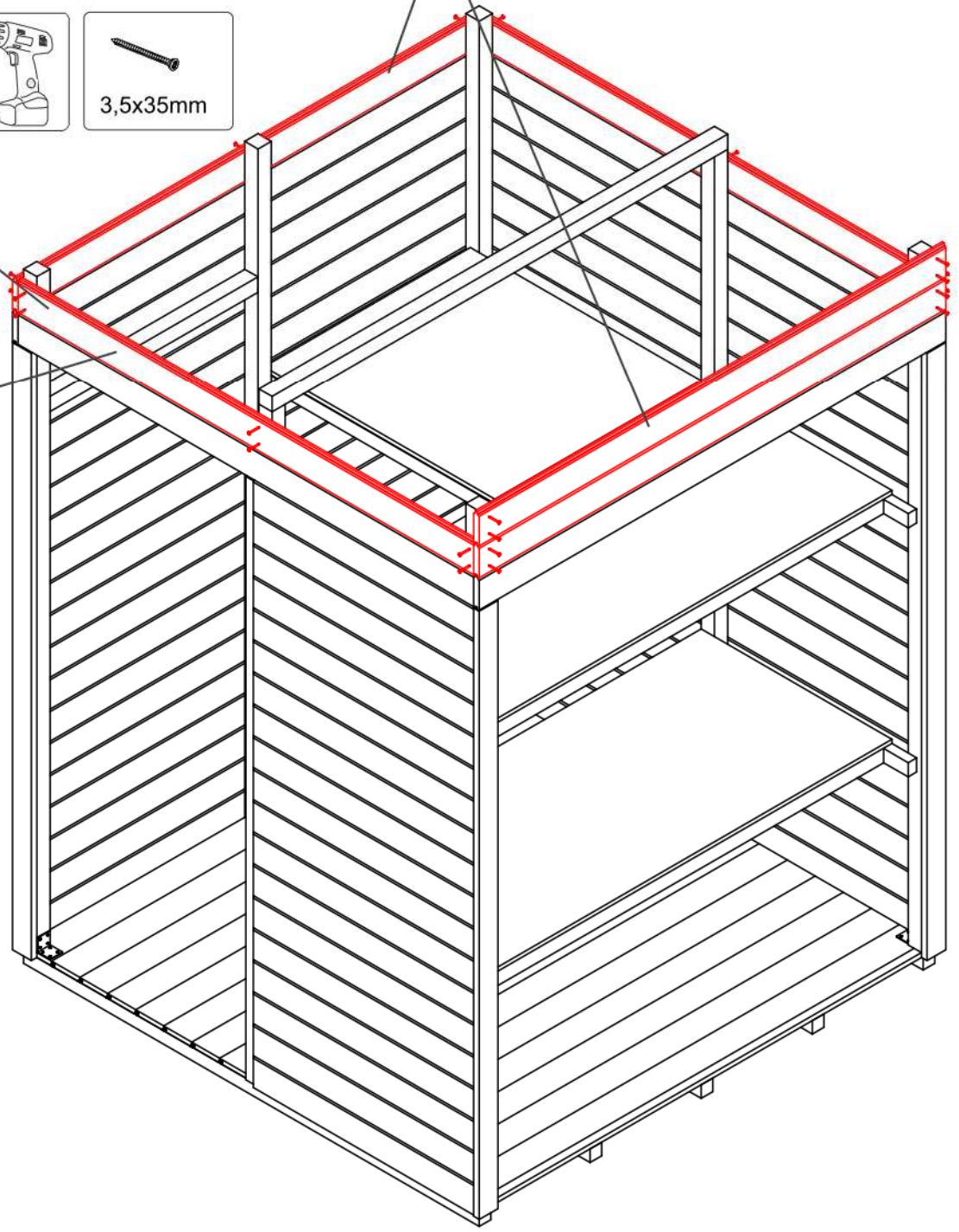

16



POS

9  18x98x1480 2X

10  18x45x1516 1X

 11X
3,5x35mm

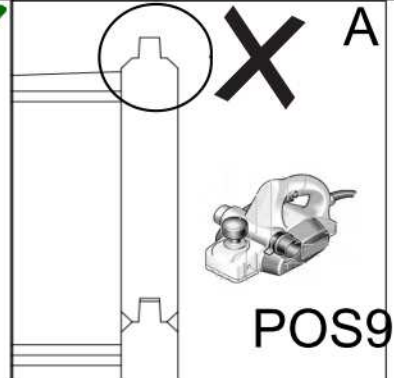
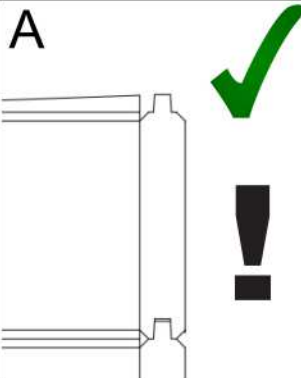

POS10

B

POS9

A

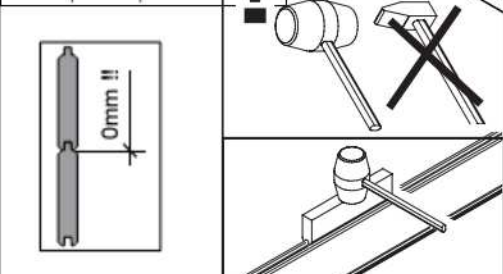
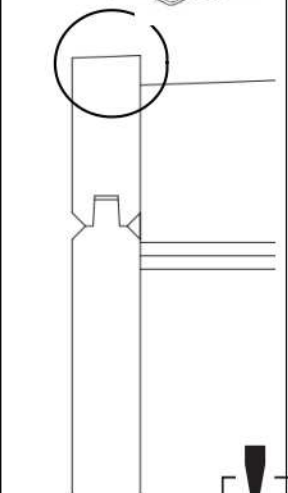
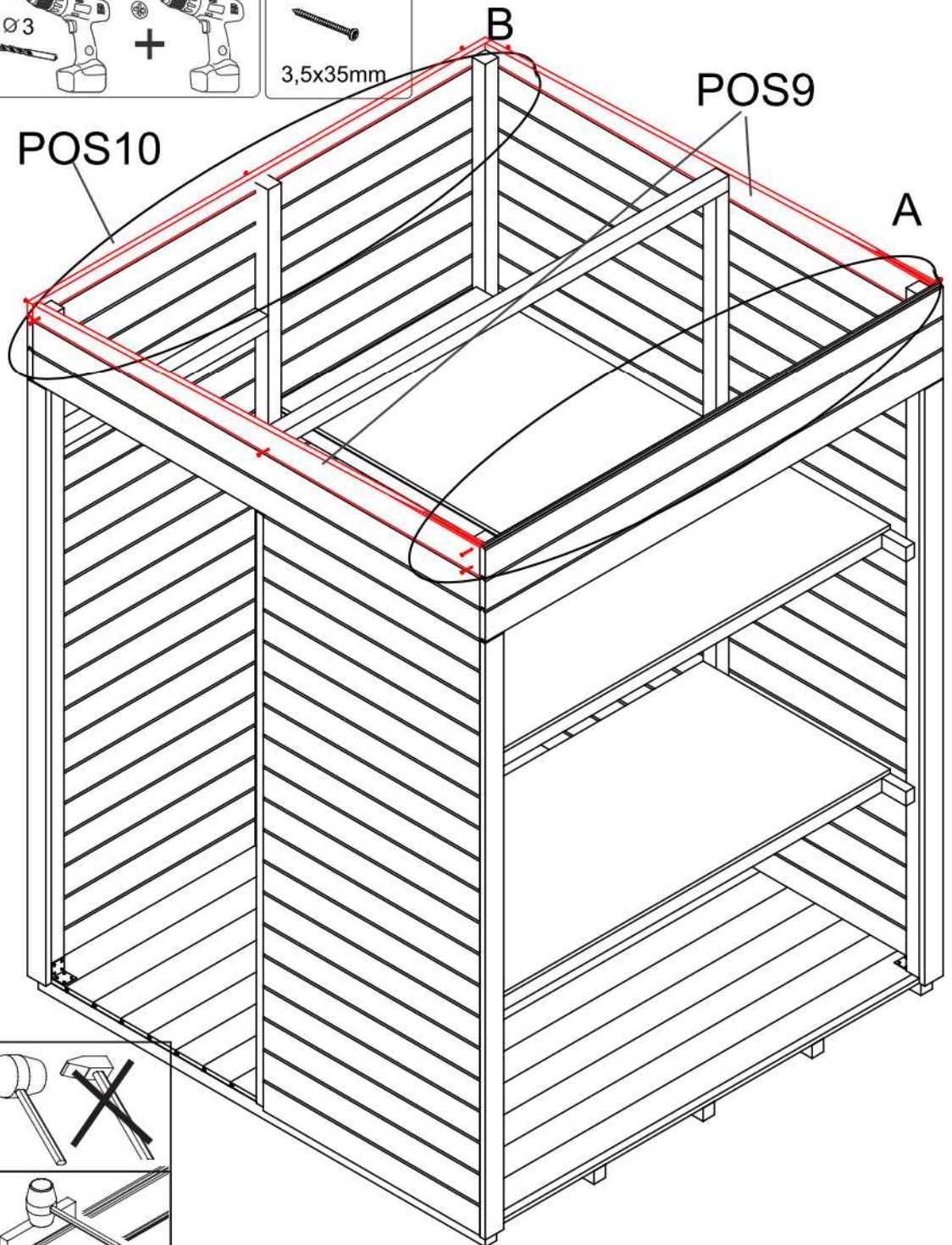

17



POS

21  12x610x1770 2X

22  12x400x1770 1X



28X

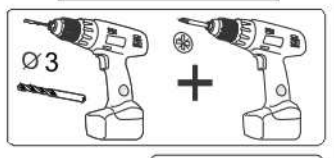
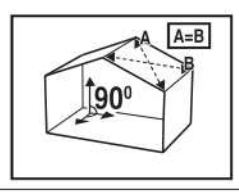

POS21

POS22

B

A

B

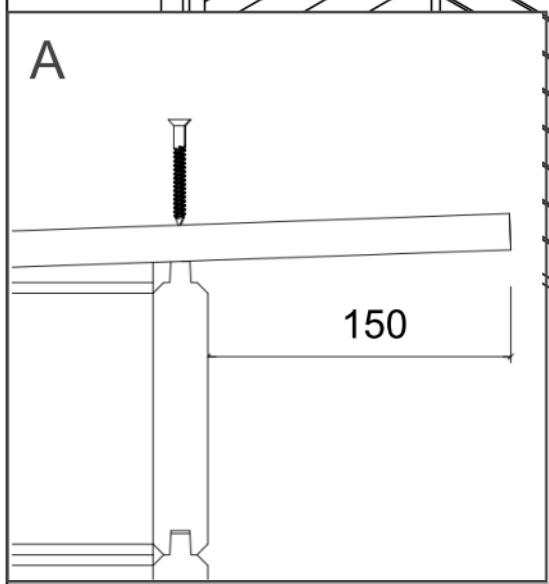

A

150

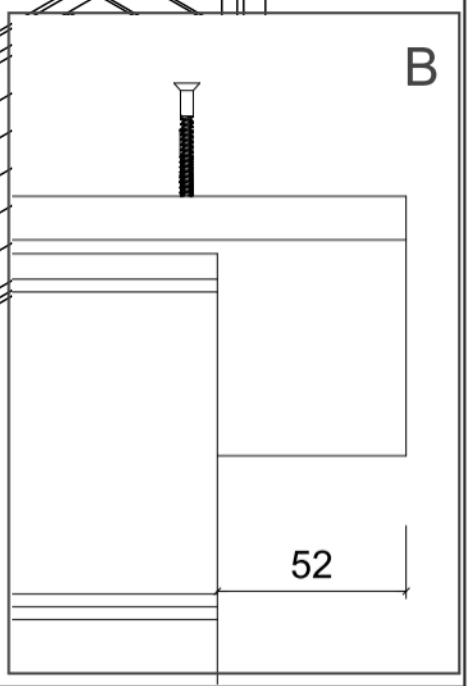

B

52

18

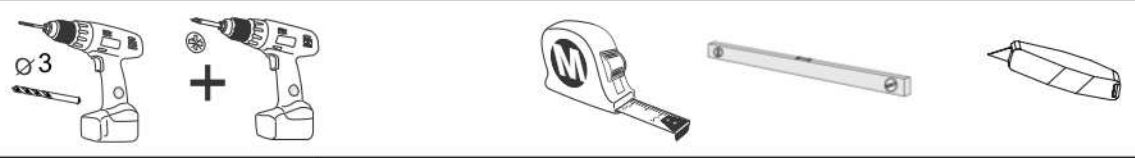

POS

27



12x26x1600 1X

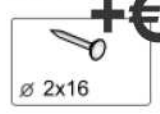

22X



4X

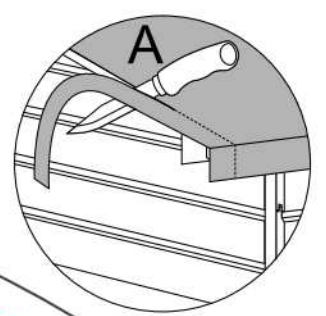
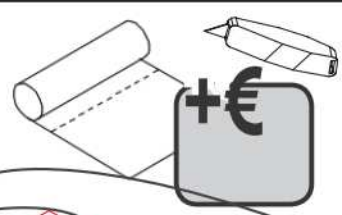

POS27

B

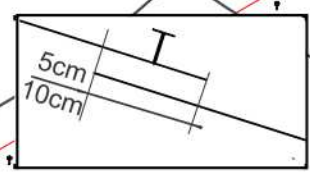

A

A

POS27

B

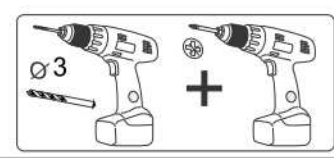
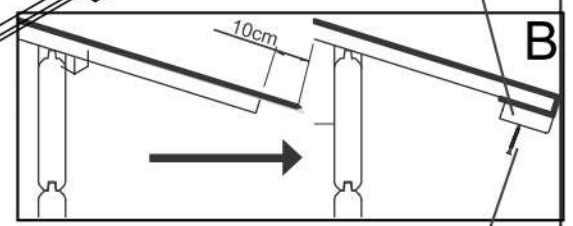
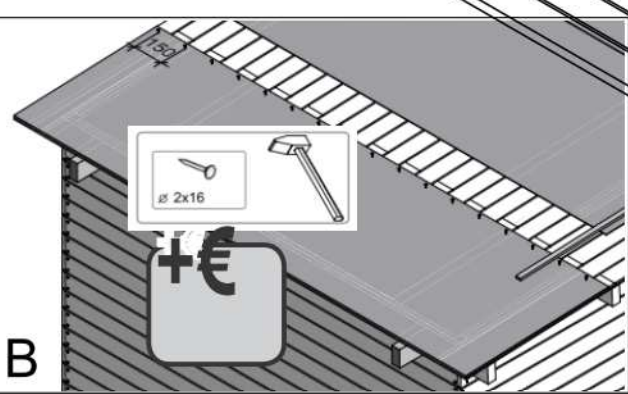

19



POS

28



20,6x27,6x1155 3X



9X

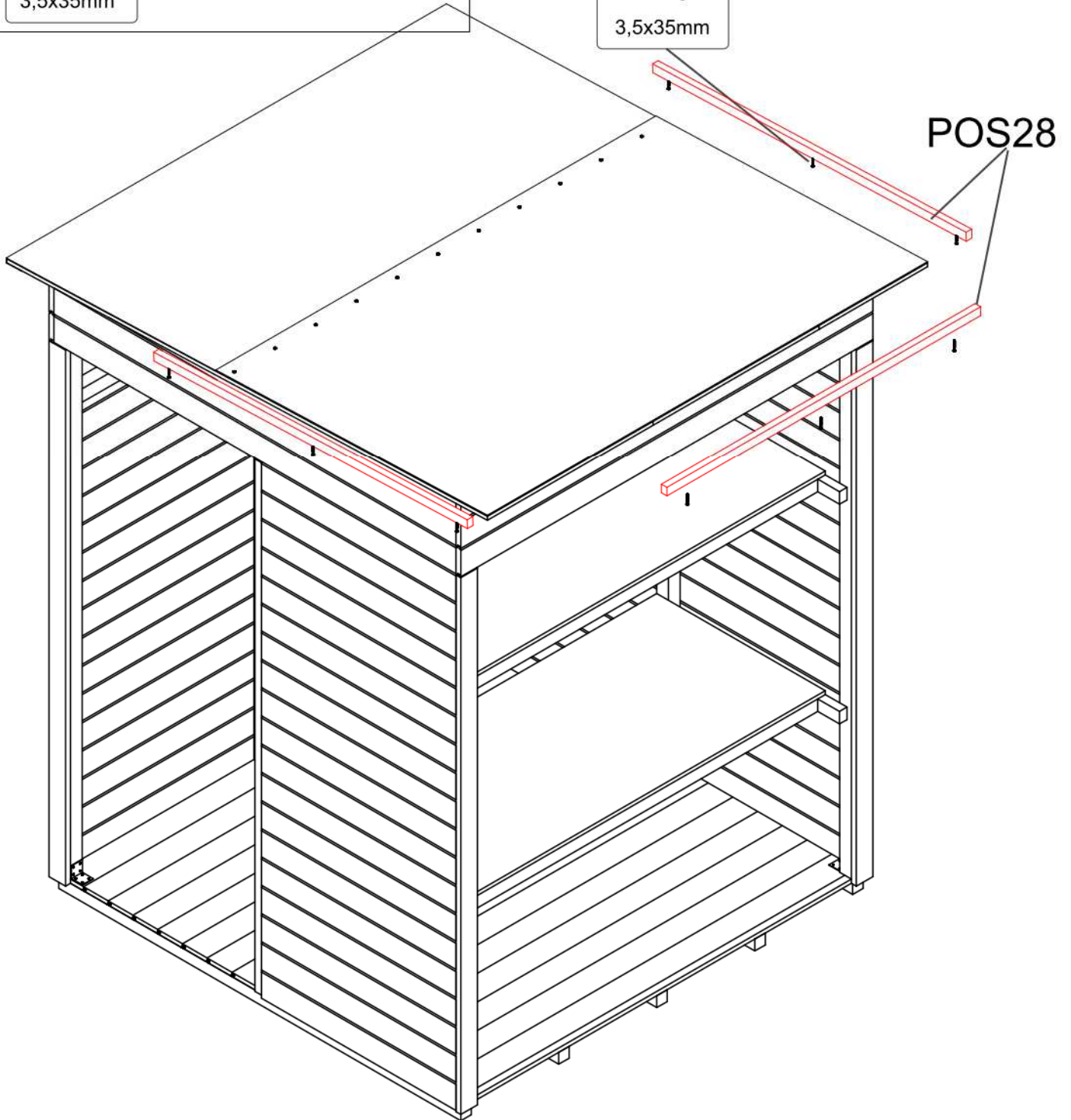
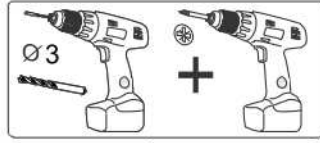

20



POS

26



12x26x1790 2X

23  15x95x1650 1X

24  15x95x1790 2X

25  12x26x1650 1X

 13X
3,5x35mm

 12X
3,5x25mm

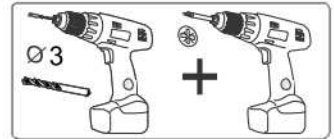
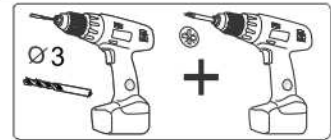

 3,5x25mm

 3,5x35mm

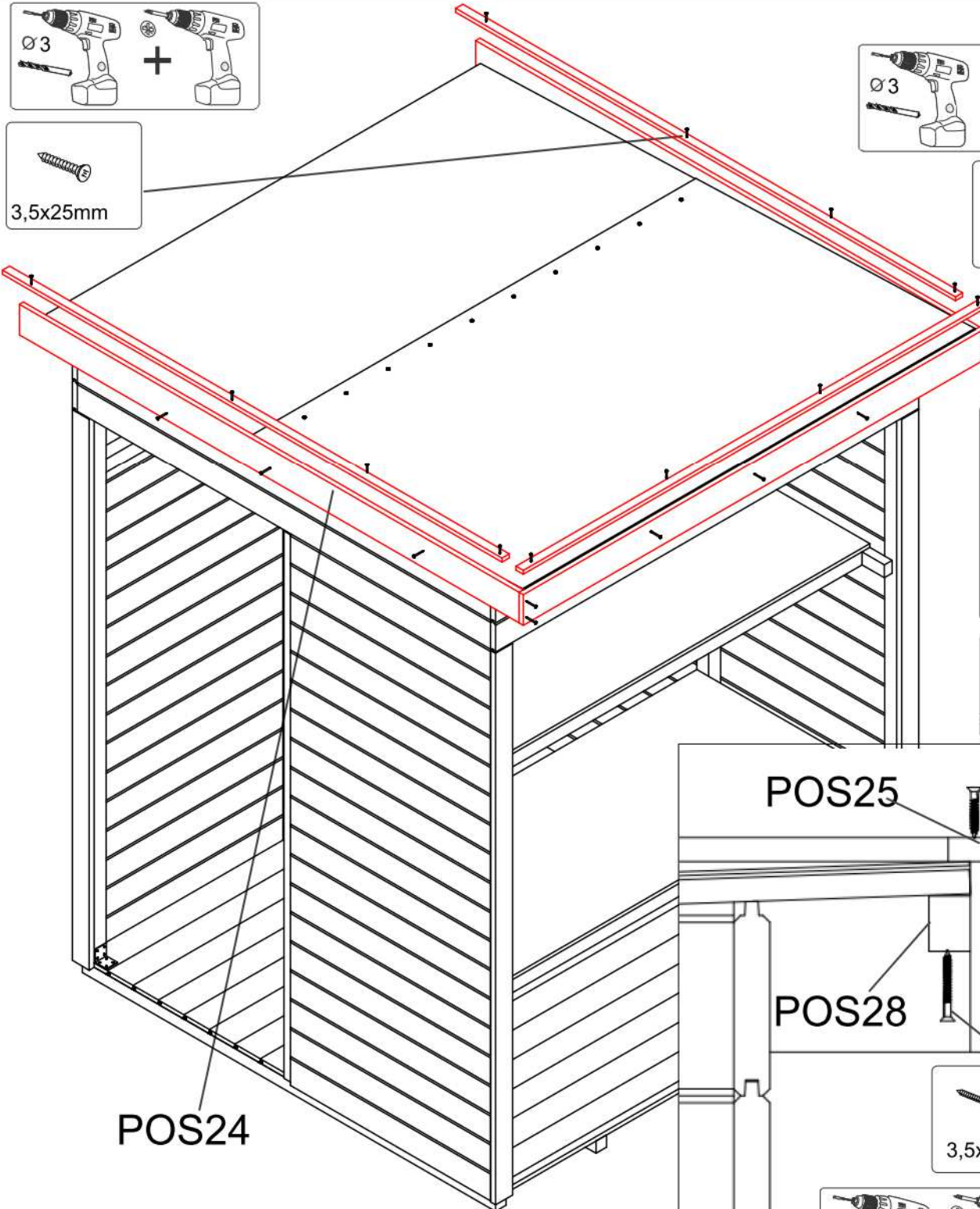

POS23

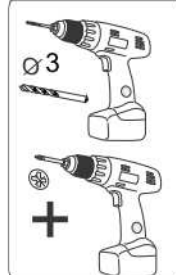

 3,5x25mm

POS25

A

POS 23

POS28

 3,5x35mm

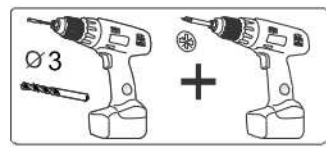

21



POS

31 Lap.688x1699_NP_Z 1X

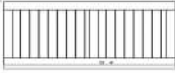

3,5x35mm
6X

4x25mm
8X

3X

3X

A

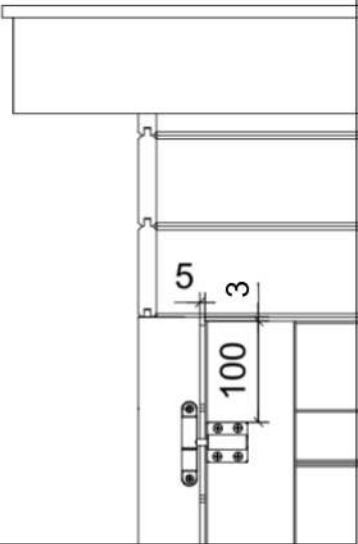

A

B

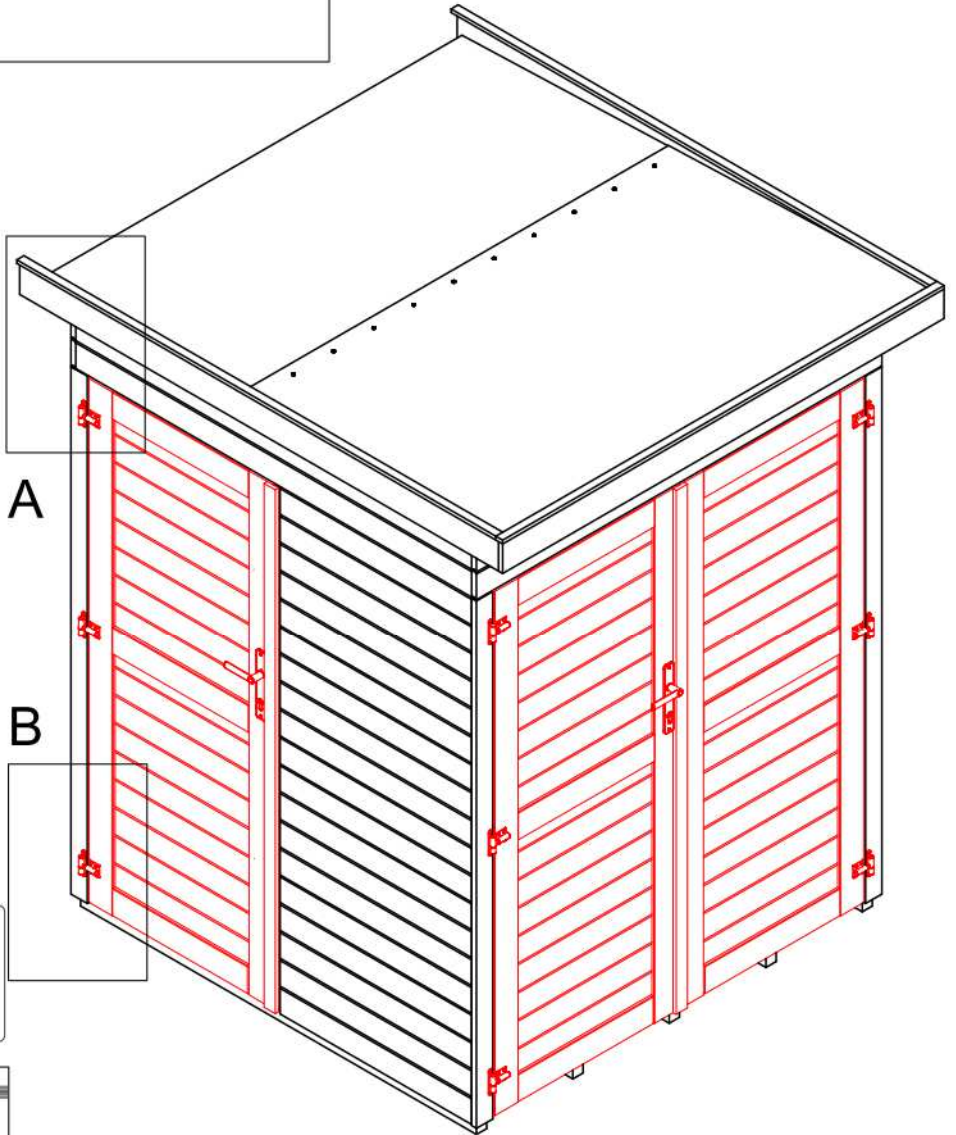

3,5x35mm

4x25mm

B

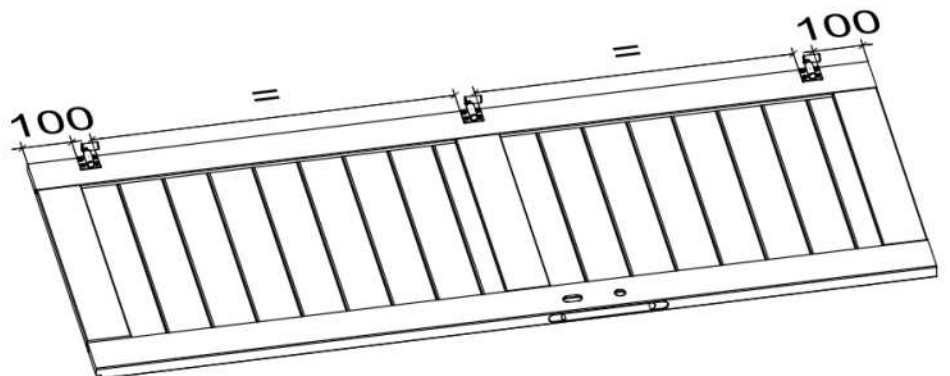
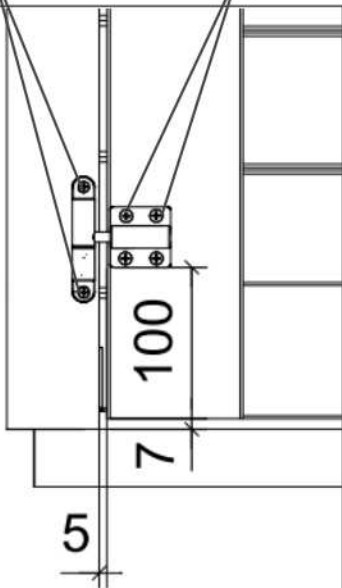

22



POS

31  Lap.688x1699_NP_Z 1X

3,5x35mm
12X



4x25mm
16X

6X

6X

32  Lap.688x1699_NP_Ü 1X

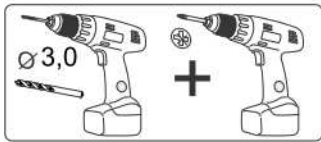
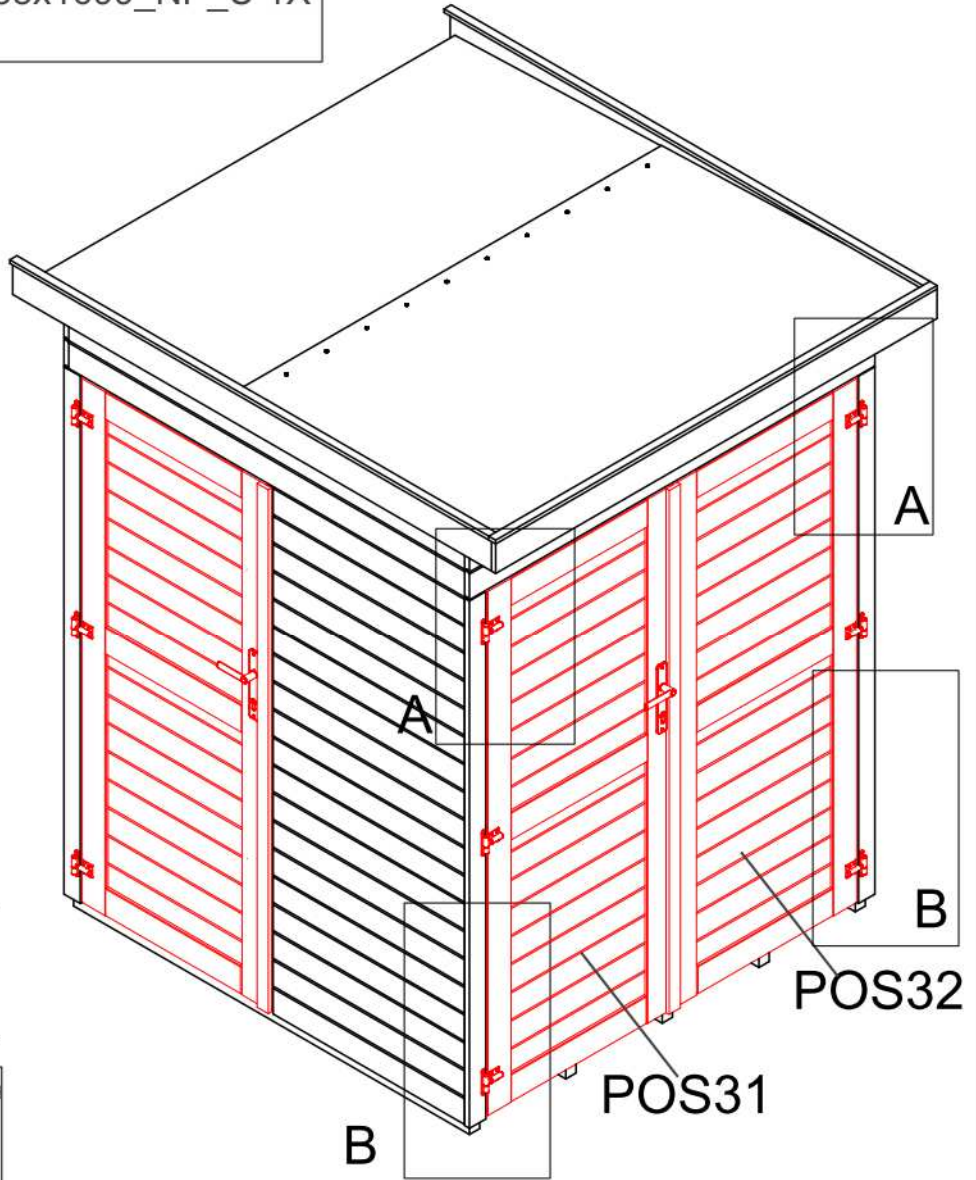
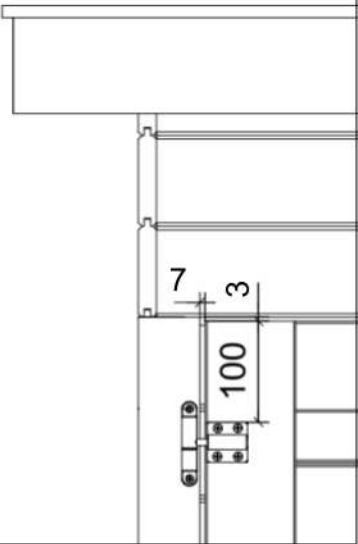
A





3,5x35mm

4x25mm

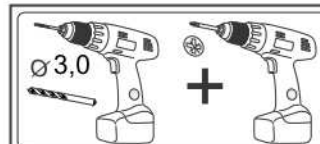
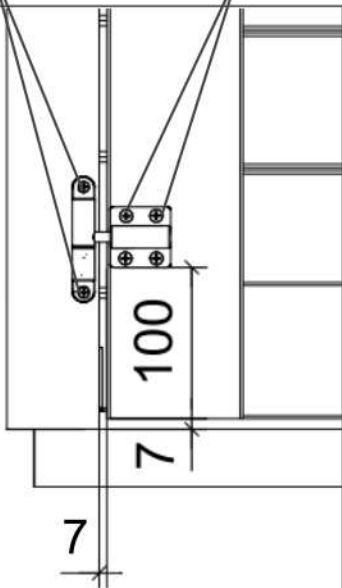
B

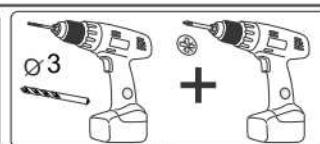

3,5x35mm



4x25mm

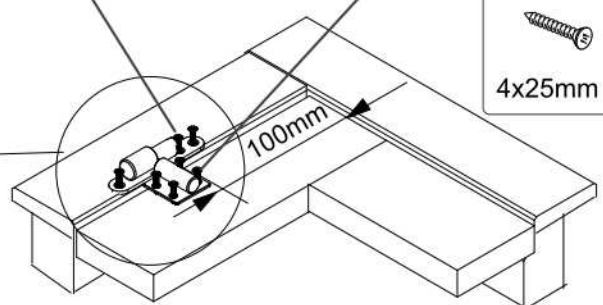
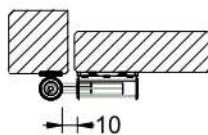

A

23



3,5x25mm

18X

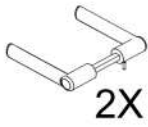

2X

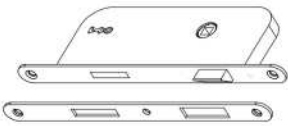

2X



2X

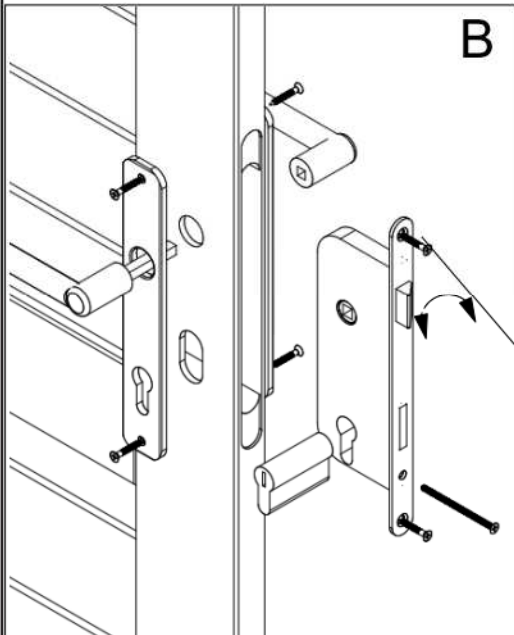
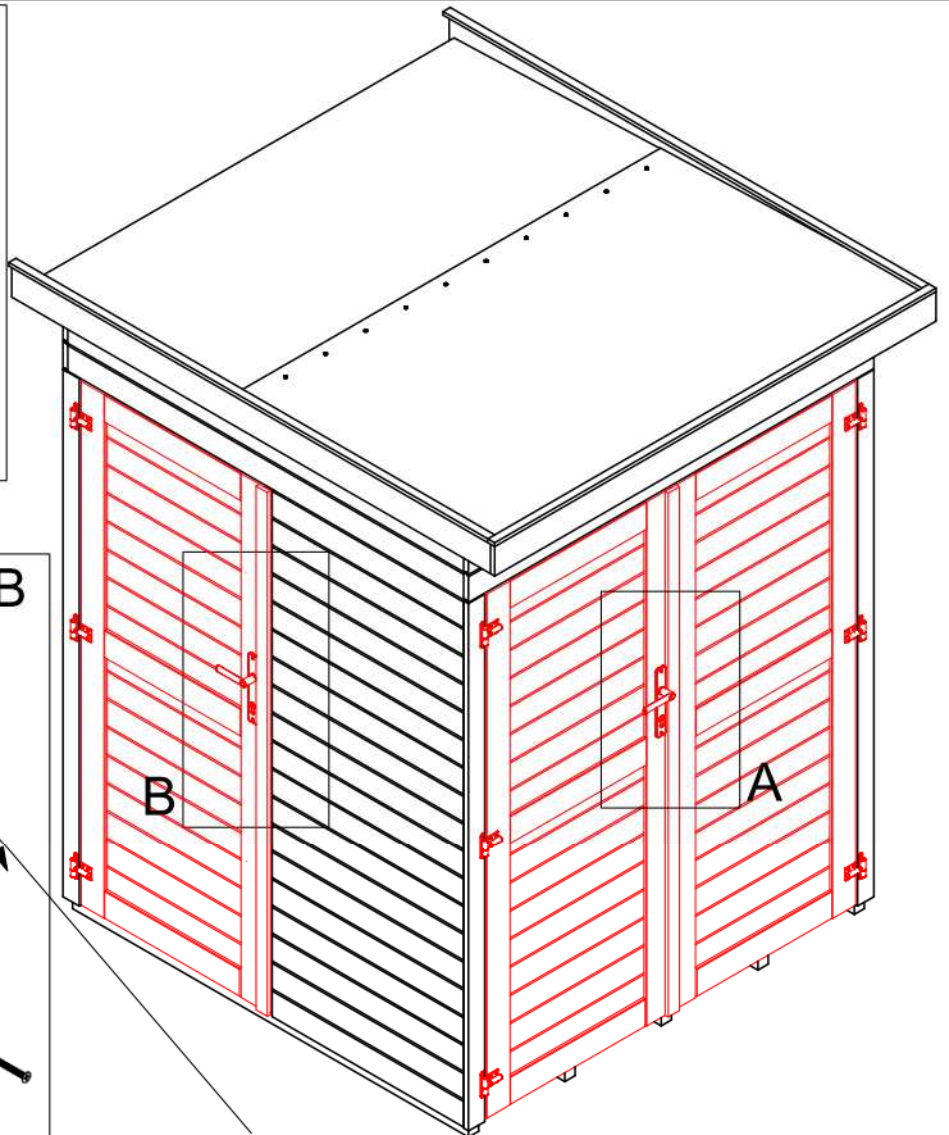

B

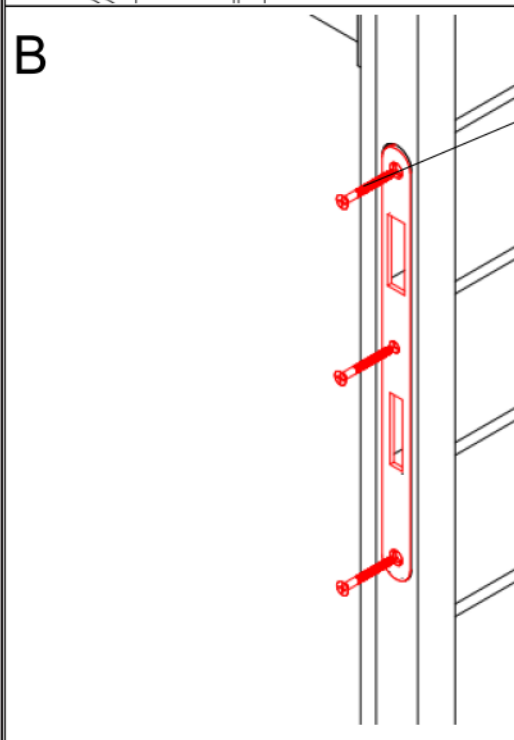

B

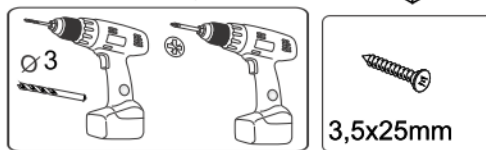

3,5x25mm

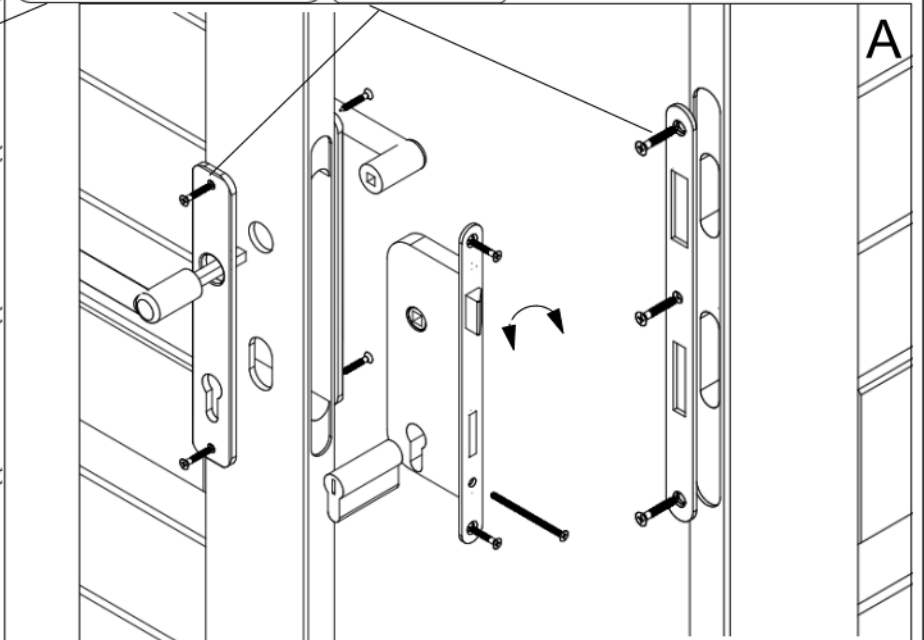

A

24



8X
3,5x25mm

2X

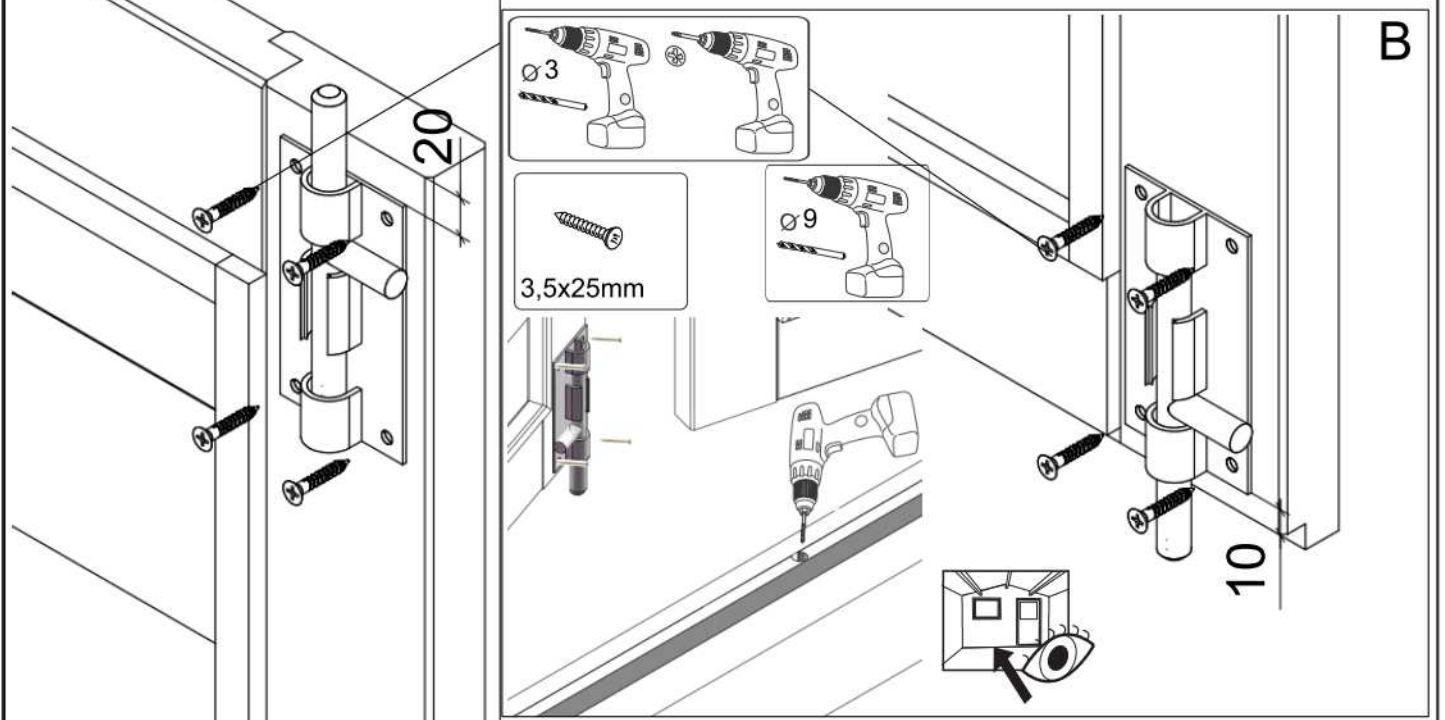
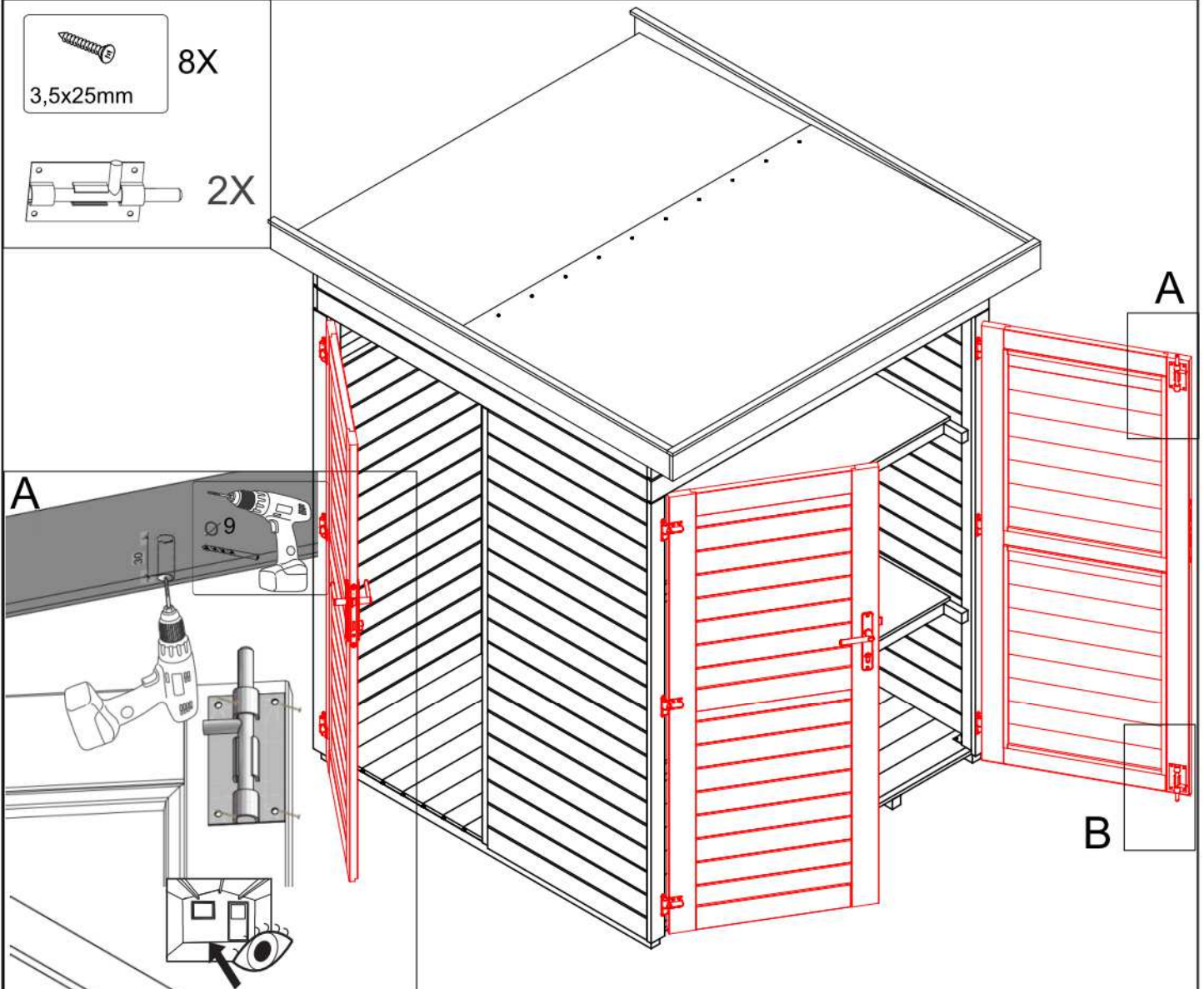

25

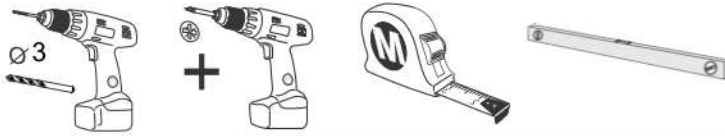

POS

33  12x42x1699 2X

 8X
3,5x25mm

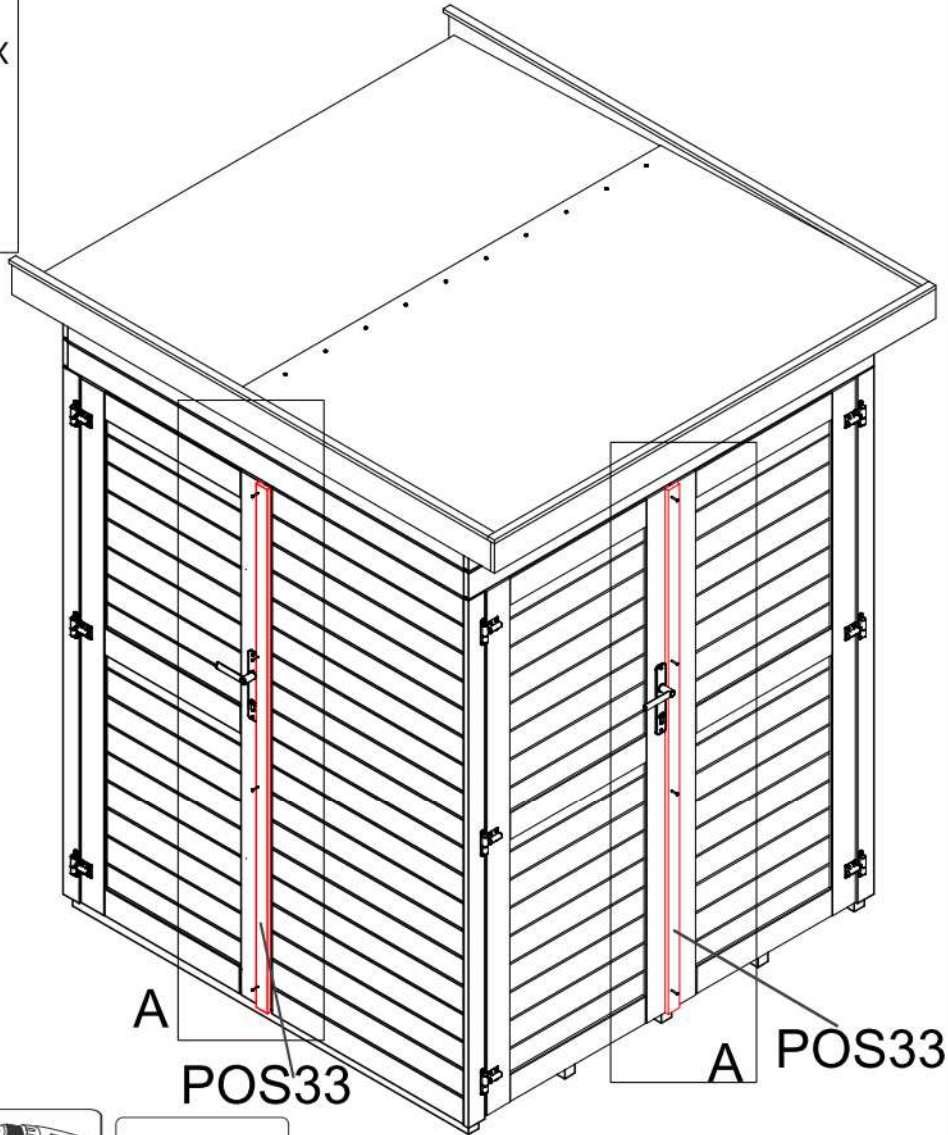
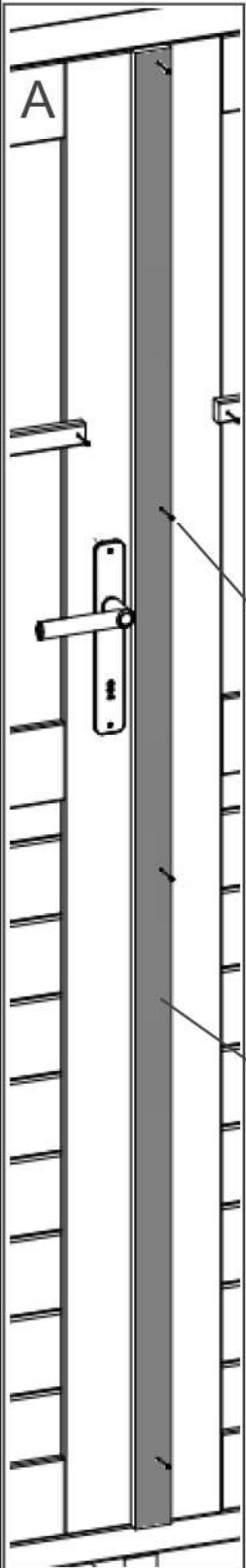

POS33

26



POS

13  12x42x1950 6X



24X

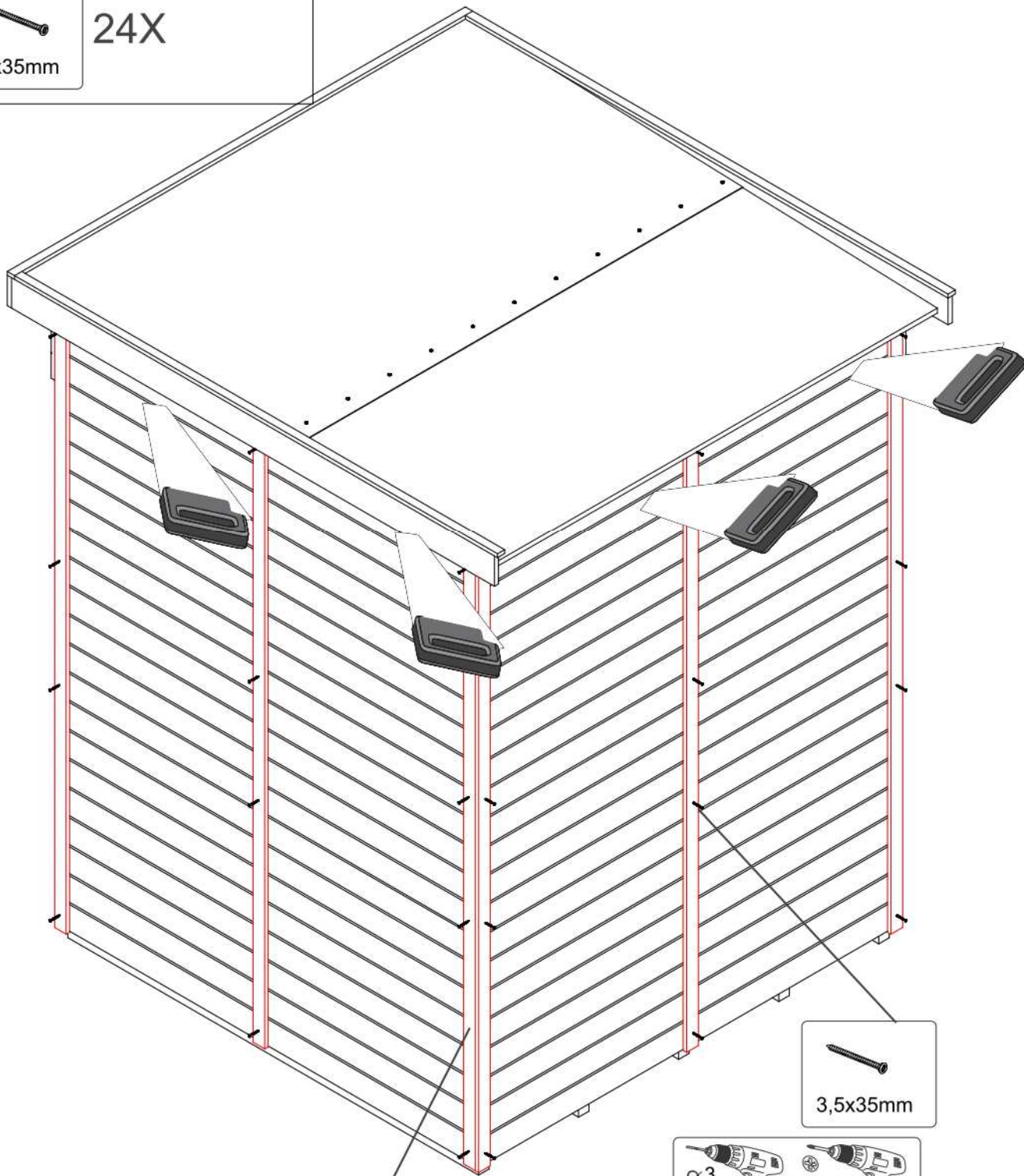

POS13

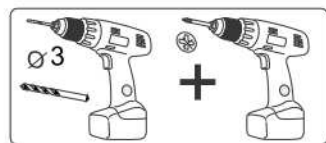

27



POS

13  12x42x1950 3X



16X

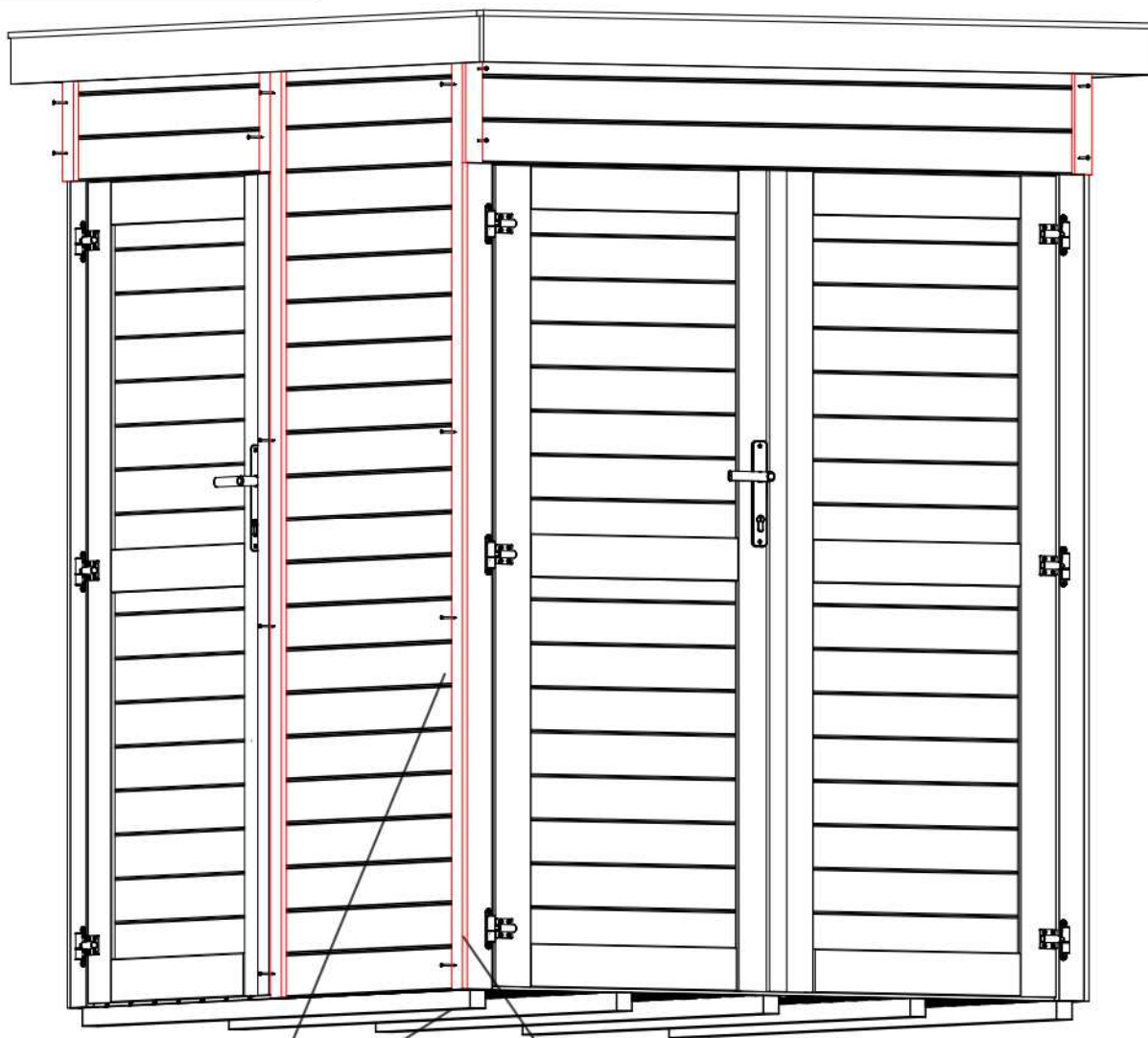

POS13

