

# Technische Daten: Art.-Nr.: 350150

Wandaußenmaß: 720 x 320 cm

Bohlenstärke: 70 mm



Kontrolliert durch:

Achtung: Alle angegebenen Maße sind ca.-Maße!

# 3D-Darstellung 350150

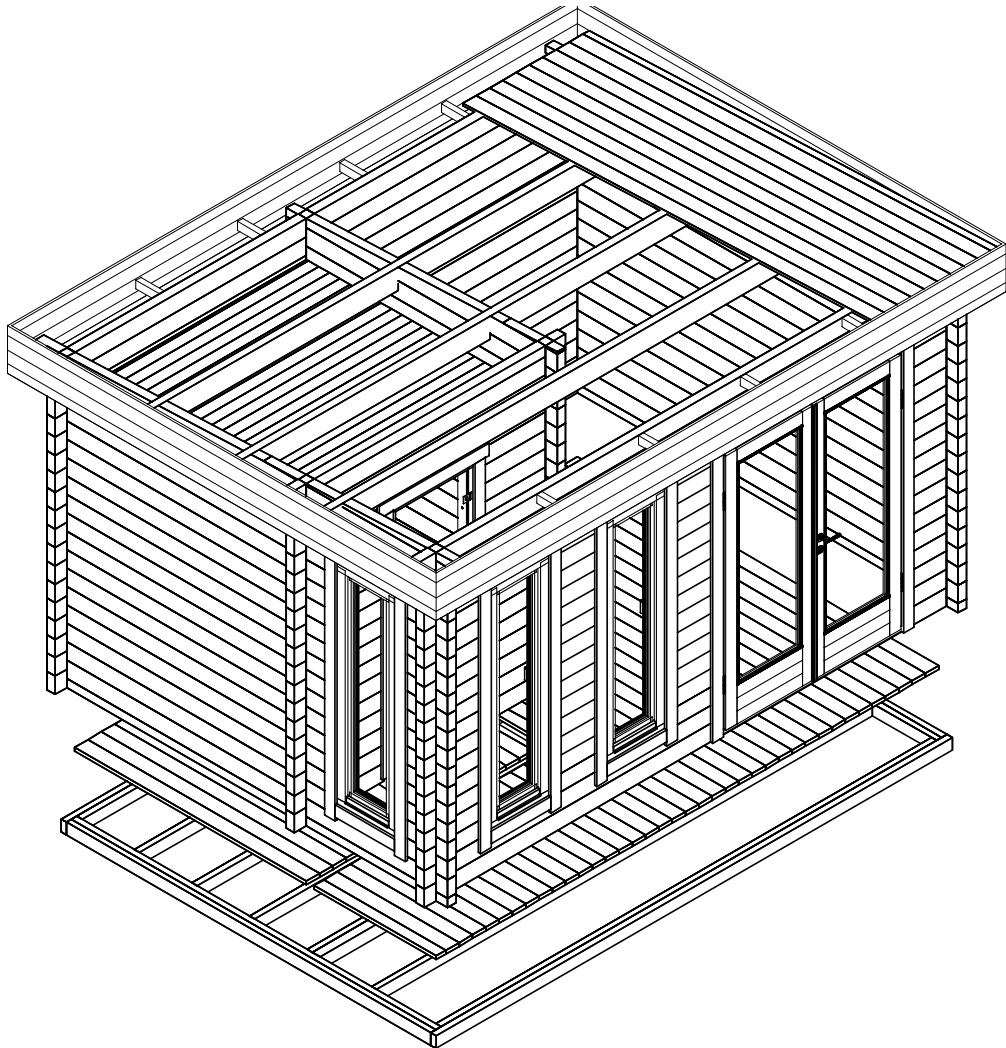









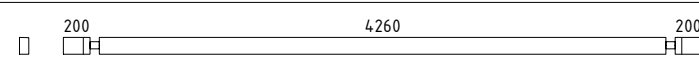
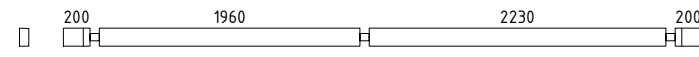
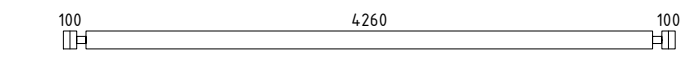
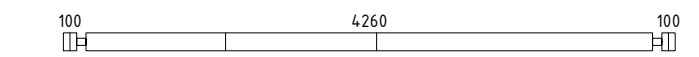
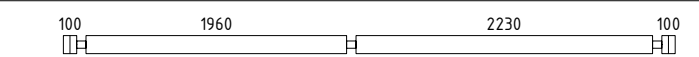
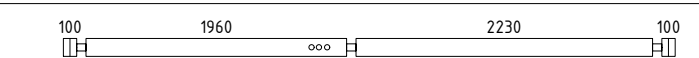
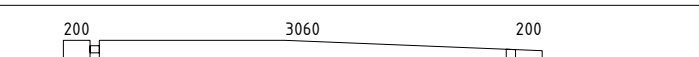
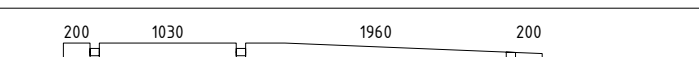

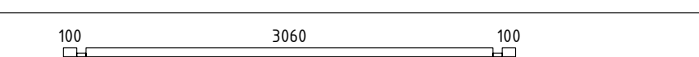
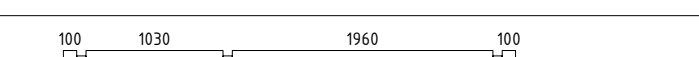
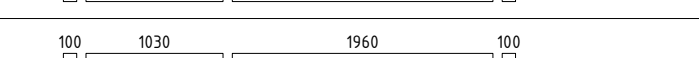
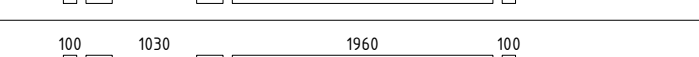
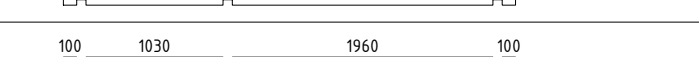

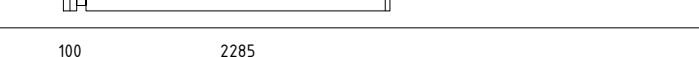
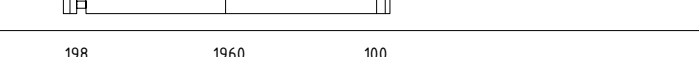

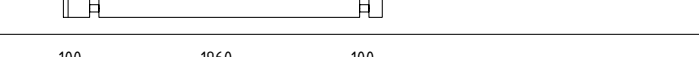
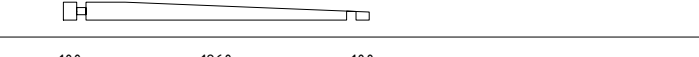

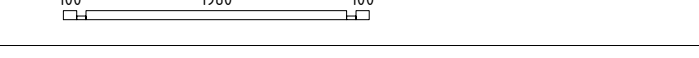
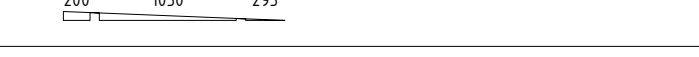







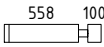







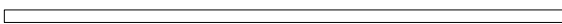

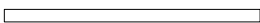
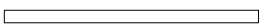
# Teilleiste 1

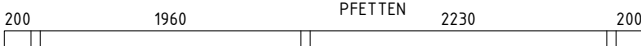
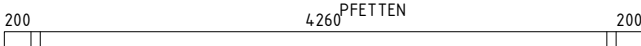
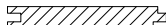
## 350150

Pos		Stck	Profil (mm)	Länge (mm)
001		1	70x127	4800
002		1	70x135	4800
003		1	70x135	4600
004		1	70x135	4600
005		15	70x135	4600
006		2	70x135	4600
007		1	70x135	3600
008		1	70x135	3600
009		17	70x135	3400
010		1	70x68	3400
011		2	70x135	3400
012		1	70x135	3400
013		1	70x135	3400
014		1	70x68	3400
015		1	70x135	2455
016		1	70x135	2455
017		1	70x135	2398
018		12	70x135	2398
019		1	70x135	2300
020		1	70x82	2300
021		20	70x135	2300
022		1	70x68	2300
023		1	70x68	1665
024		1	70x68	1665
025		15	70x135	763













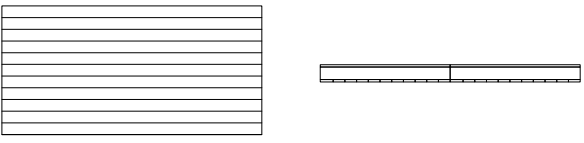
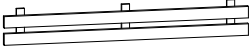

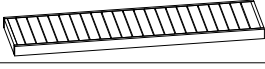
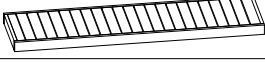
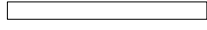

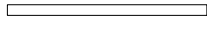
# Teilleiste 2

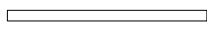
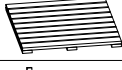
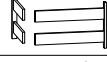
## 350150

Pos		Stck	Profil (mm)	Länge (mm)
026		15	70x135	728
027		30	70x135	485
028		1	70x19	465
029		13	70x135	368
030		20	70x135	350
031		8	70x135	350
FH7	FUNDAMENTHÖLZER (imprägniert) 	1	68x94	2122
FH3	FUNDAMENTHÖLZER (imprägniert) 	2	44x94	4380
FH4	FUNDAMENTHÖLZER (imprägniert) 	4	44x94	4204
FH1	FUNDAMENTHÖLZER (imprägniert) 	4	44x94	3092
FH6	FUNDAMENTHÖLZER (imprägniert) 	3	44x94	2193
FH5	FUNDAMENTHÖLZER (imprägniert) 	3	44x94	1923
FH2	FUNDAMENTHÖLZER (imprägniert) 	2	44x94	1911
HS1	HOLZSCHWELLE (unter der Saunafür) 	✓ 1	75x28	750
PF1	PFETTEN 	2	58x170	4800
PF2	PFETTEN 	1	58x170	4800
	DACHBRETTER 	43+1	113x18	3505
	FUSSBODENBRETTER 	20+1	113x28	3065
	FUSSBODENBRETTER 	18	113x28	1965
	FUSSBODENBRETTER 	18	113x28	1035
	ABDECKLEISTEN 	✓	15x28	18.0lfm
	FUSSBODENLEISTEN 	✓	14x55	25.0lfm
BL-1	DACHBLENDEN 350mm 	2	18x350	3600
BL-2	DACHBLENDEN 350mm 	2	18x350	4836
BS-1	DACHBLENDEN- Blendenstützen 44x65 	8	44x65	200











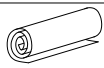





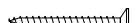

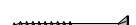

# Teileliste 3

## 350150

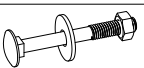
Pos			Stck	Profil (mm)	Länge (mm)
UPB-1	DACHBLENDEN- U-Profil für Blenden		✓	65x44	17.5lfm
DPL-1	DACHPAPPENLEISTEN 15x28		✓	15x28	12.0lfm
T06-1	TRAUFENLEISTEN 18x40		✓	18x40	10.0lfm
	DECKENISOLATION		2 Elemente	ca 1950x975	
SA16-1	SAUNA - Bänke Zwischenstück		1	40x300	1955
SA15-1	SAUNA - Rücklehne		2	40x250	1860
SA02-1	SAUNA - Saunabank 50cm		1	500x90	1355
SA01-1	SAUNA - Saunabank 60cm		2	600x90	1955
SA11-1	SAUNA - Stützpfeiler für Saunabänke		✓	44x65	500
SA11-2	SAUNA - Stützpfeiler für Saunabänke		✓	44x65	1000
SA20-1	SAUNA - Trägleiste für Deckenisolation		✓	35x35	2010
SA10-1	SAUNA - Trägleiste für Saunabänke		✓	30x40	500
SA10-2	SAUNA - Trägleiste für Saunabänke		✓	30x40	600
SA10-3	SAUNA - Trägleiste für Saunabänke		✓	30x40	1200
SA37	SAUNA - Bodenrost		1		
SA30	SAUNA - Heizung Umbau (set 1)		1		
SA35	SAUNA - Kopfstütze		2		
SA36	SAUNA - Luftschieber		3		
TL70-1	T-LEISTE 70		2	45x70	1705
TL70-2	T-LEISTE 70		4	45x70	1840
TL70-3	T-LEISTE 70		2	45x70	1975
TL70-4	T-LEISTE 70		2	45x70	2110
SH	Schlaghölzer		3		

# Teilleiste 4

## 350150

Pos		Stck.	Profil (mm)	Länge (mm)
KP-1	DACHPAPPE 	✓	5.5m-5'st	30.0lfm
SA2 5-1	SAUNA - Dichtungsband für Deckenisolationselemente 	✓		8.0lfm
ML1	Metallstange 	4	D10	900
ML2	Metallstange 	2	D10	770
NG01	DACHPAPPNÄGEL 2.8x15 	400		
NG04	NÄGEL 2.5x50  Dachbretter	430		
SR32	SCHRAUBEN 3.0x30  Abdeckleisten, Fussbodenleisten Dachpappenleisten, Traufenleisten 40x18 Bänke Zwischenstück, Luftschieber	150		
SR37	SCHRAUBEN 3.5x45  Heizung Umbau Türleisten (LR)	30		
SR3 550	SCHRAUBEN 3.5x45 C3  U-Profil	36		
SR3 550	SCHRAUBEN 3.5x45 C3  Fenster- und Türleisten	96		
SR44	SCHRAUBEN 4.0x60  Trägleiste für Saunabänke Trägleiste für Deckenisolation, Rücklehne	61		
SR4 210	SCHRAUBEN 4.2x55 C2  28mm Fussbodenbretter Holzschwelle	321		
SR57	SCHRAUBEN 5.0x100  Fundamenthölzer	76		
SR55	SCHRAUBEN 5.0x70  Blendenbefestigung Stützpfeiler für Saunabänke	54		
SR61	SCHRAUBEN 6.0x140  Blendenbestütze	16		
SS023	Schloßschrauben M8x70 Mutter M8 U-Scheibe Ø25 - Befestigung für Saunabänke 	2		
KL1	Gewindestange M8 	4		2000
KL2	Gewindestange M8 	2		587
KL3	Gewindestange M8 	2		460
	Mutter M8 	8		
	U-Scheibe M8 Ø25 	8		
	Befestigungsmutter M8 	4		

**Achtung Hinweis:**  
wir empfehlen die Stromverkabelung für den Elektro-Saunaofen vor  
Verlegung von den Fußbodenbrettern durchzuführen.



# Teilleiste 5

## 350150

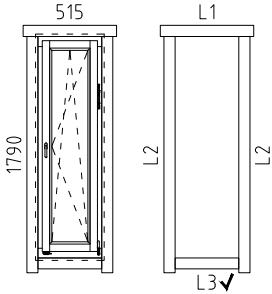
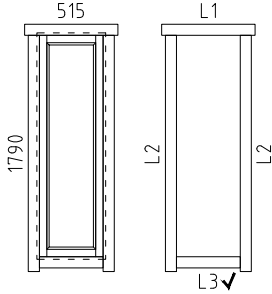
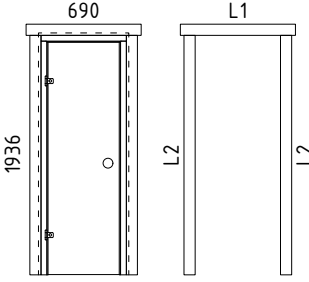
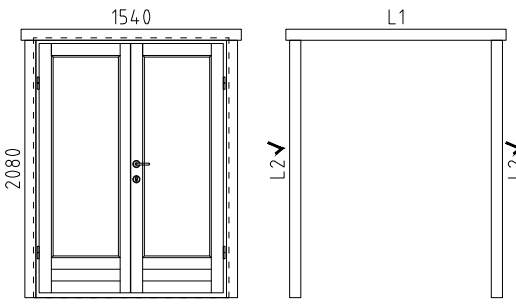
Pos		Stck.	Profil (mm)	Länge (mm)
	<p>FENSTER 515x1790 A58-10 70</p>  <p>A58-10</p> <p>L1 18x90 L=755mm 2x  L2 18x90 L=1910mm 4x  L3 18x90 L=515mm 2x ✓</p>	2		
	<p>FENSTER 515x1790 A58-10F 70</p>  <p>A58-10F</p> <p>L1 18x90 L=755mm 2x  L2 18x90 L=1910mm 4x  L3 18x90 L=515mm 2x ✓</p>	1		
	<p>TÜR 690x1936 LR 70</p>  <p>LR</p> <p>L1 18x90 L=930mm 2 Stck.  L2 18x90 L=1935mm 4 Stck. ✓</p> <p>DIN links</p>	1		
	<p>TÜR 1540x2080 TU4-SH (208) 70</p>  <p>TU4-SH</p> <p>L1 18x90 L=1780mm 2x  L2 18x90 L=2080mm 4x ✓</p> <p>DIN rechts</p>	1		
	<p>✓ - bitte selber anpassen (falls nötig)!</p>			

# Wandplan 1 350150

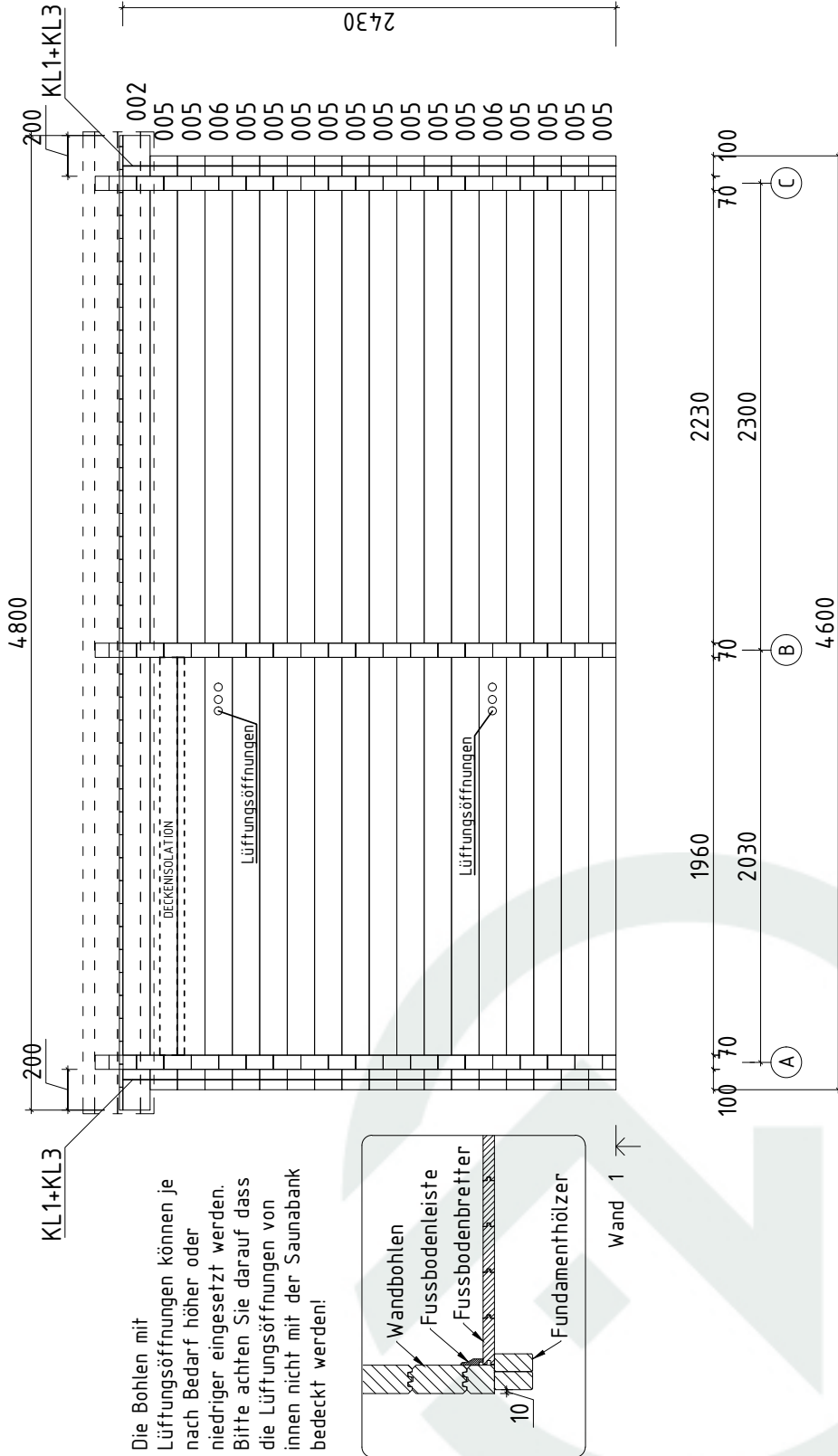



# Wandplan A 350150

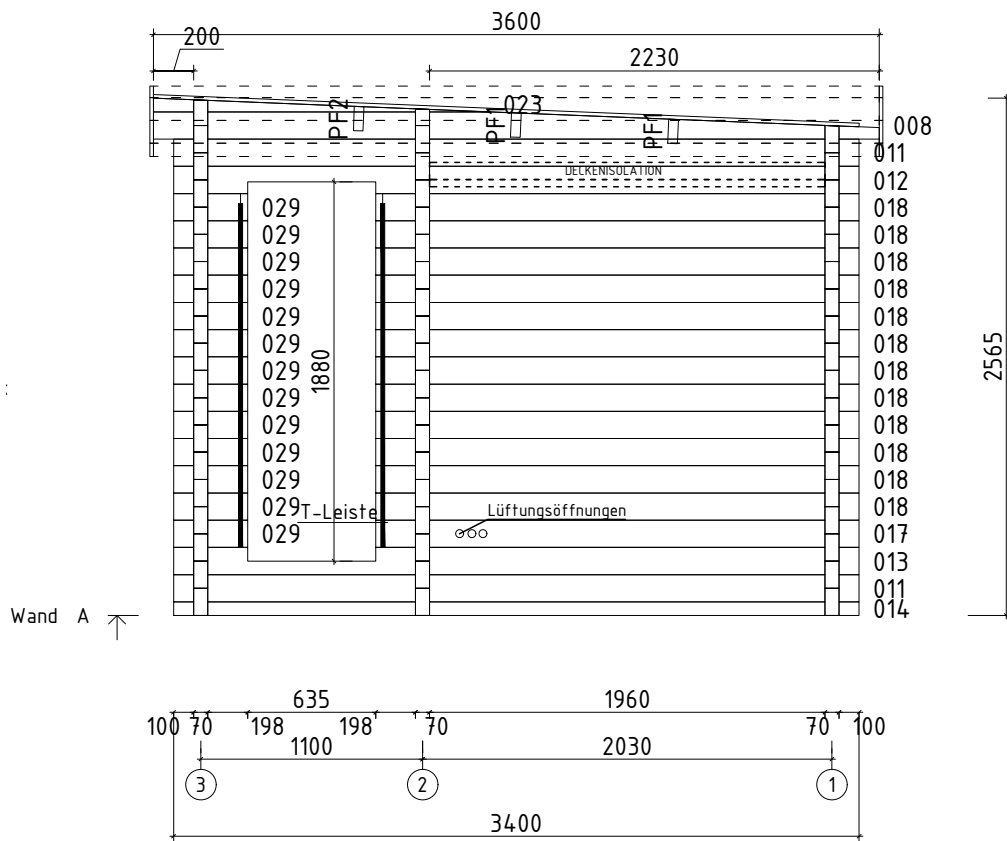

Die Bohlen mit Lüftungsöffnungen können je nach Bedarf höher oder niedriger eingesetzt werden. Bitte achten Sie darauf dass die Lüftungsöffnungen von innen nicht mit der Saunabank bedeckt werden!

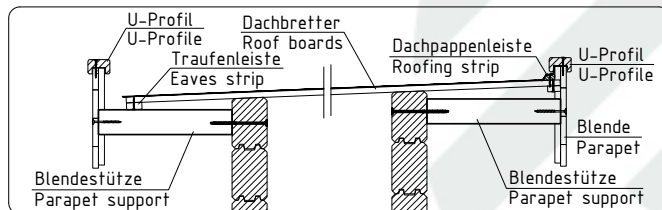

# Wandplan B und C 350150

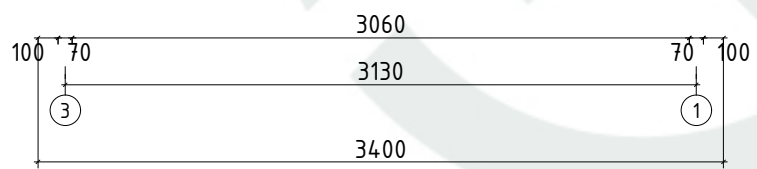
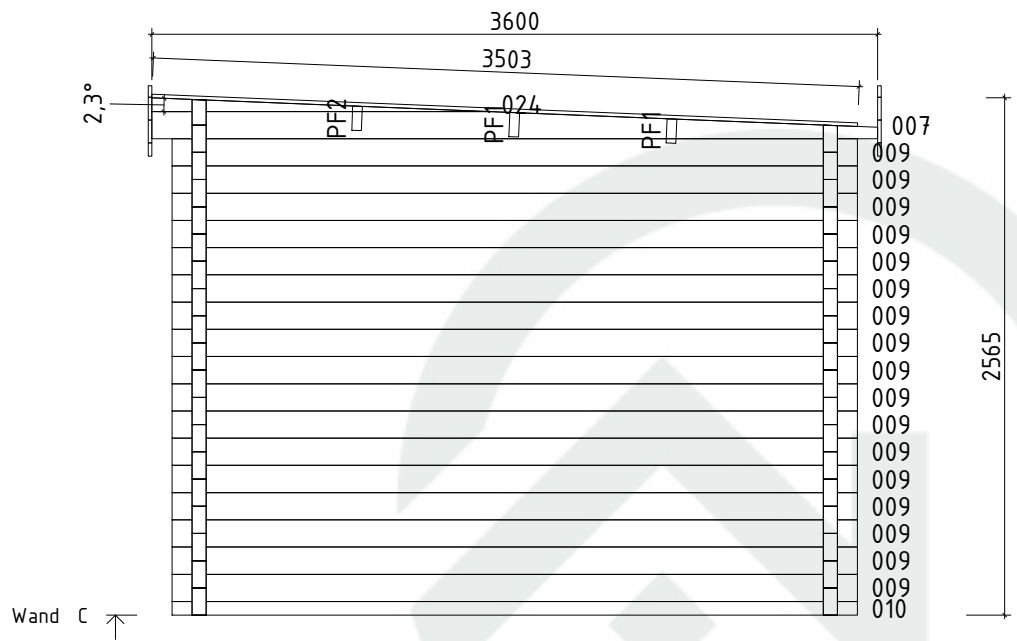
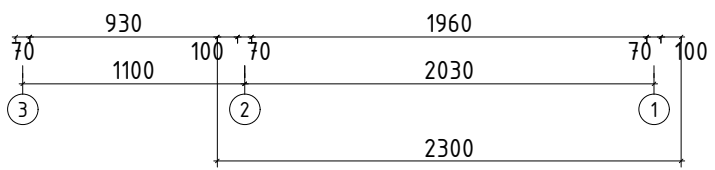
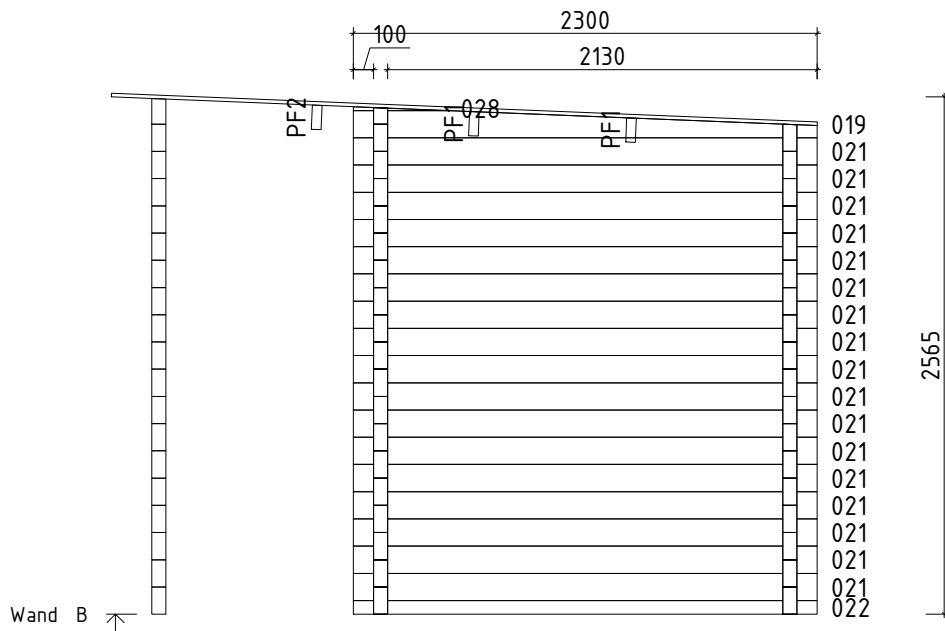

# Montageanleitung für T-Leisten 350150

Montageanleitung für T-Leisten / Installing the door and window supports / Tenderliistu paigaldusjuhend.

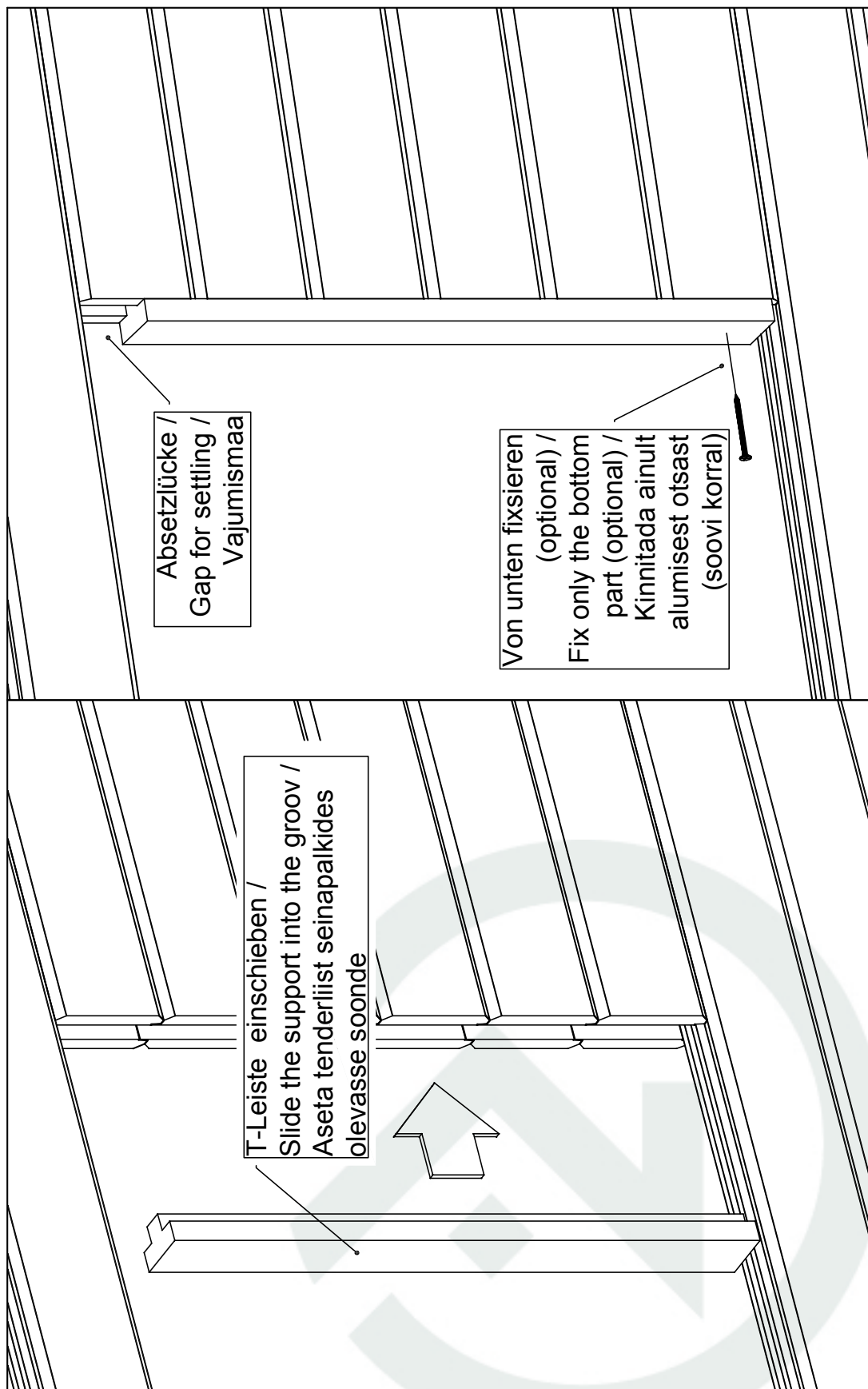

# Details 350150

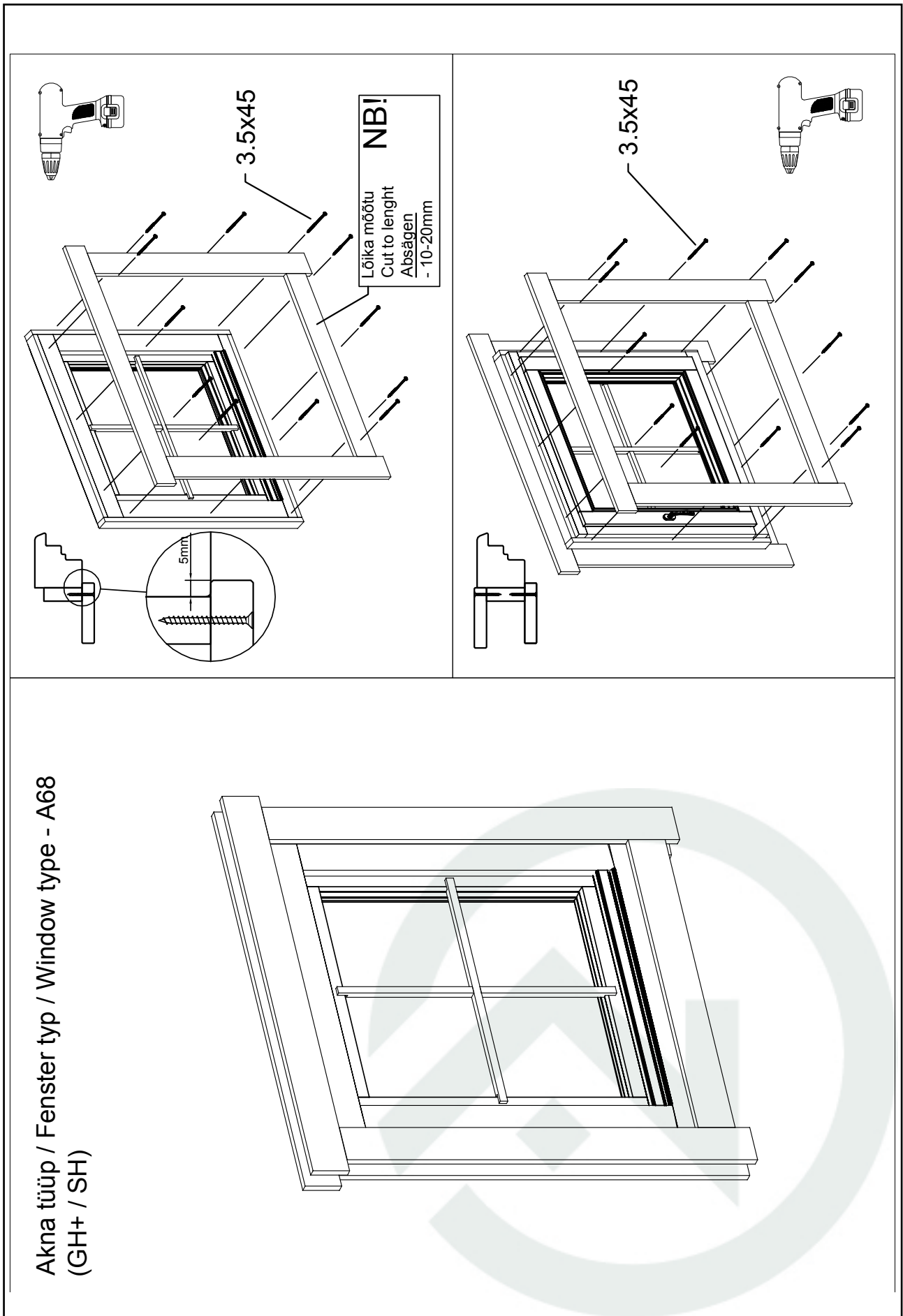

Akna tüüp / Fenster typ / Window type - A68  
(GH+ / SH)

# Details 350150

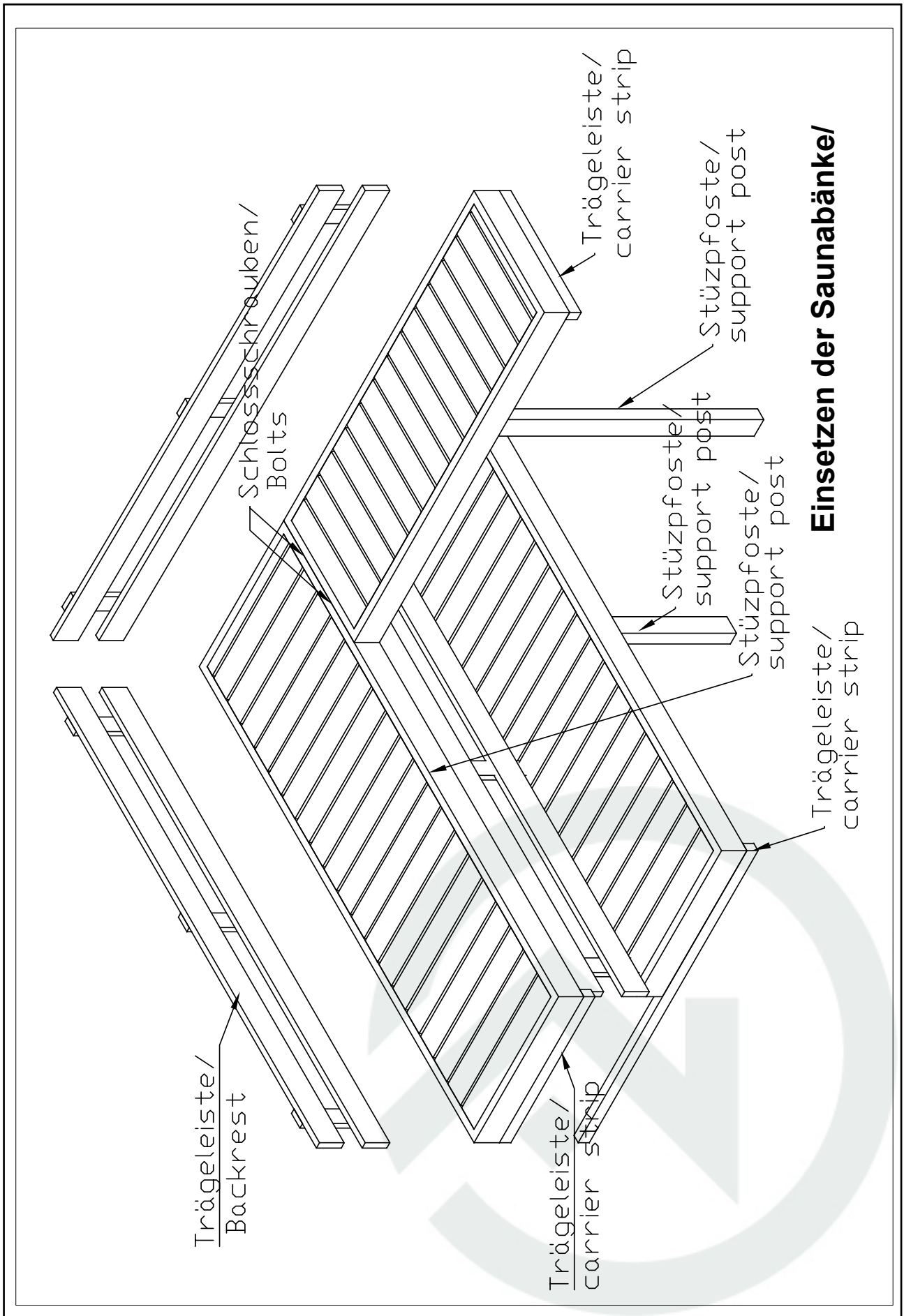



# Details 350150

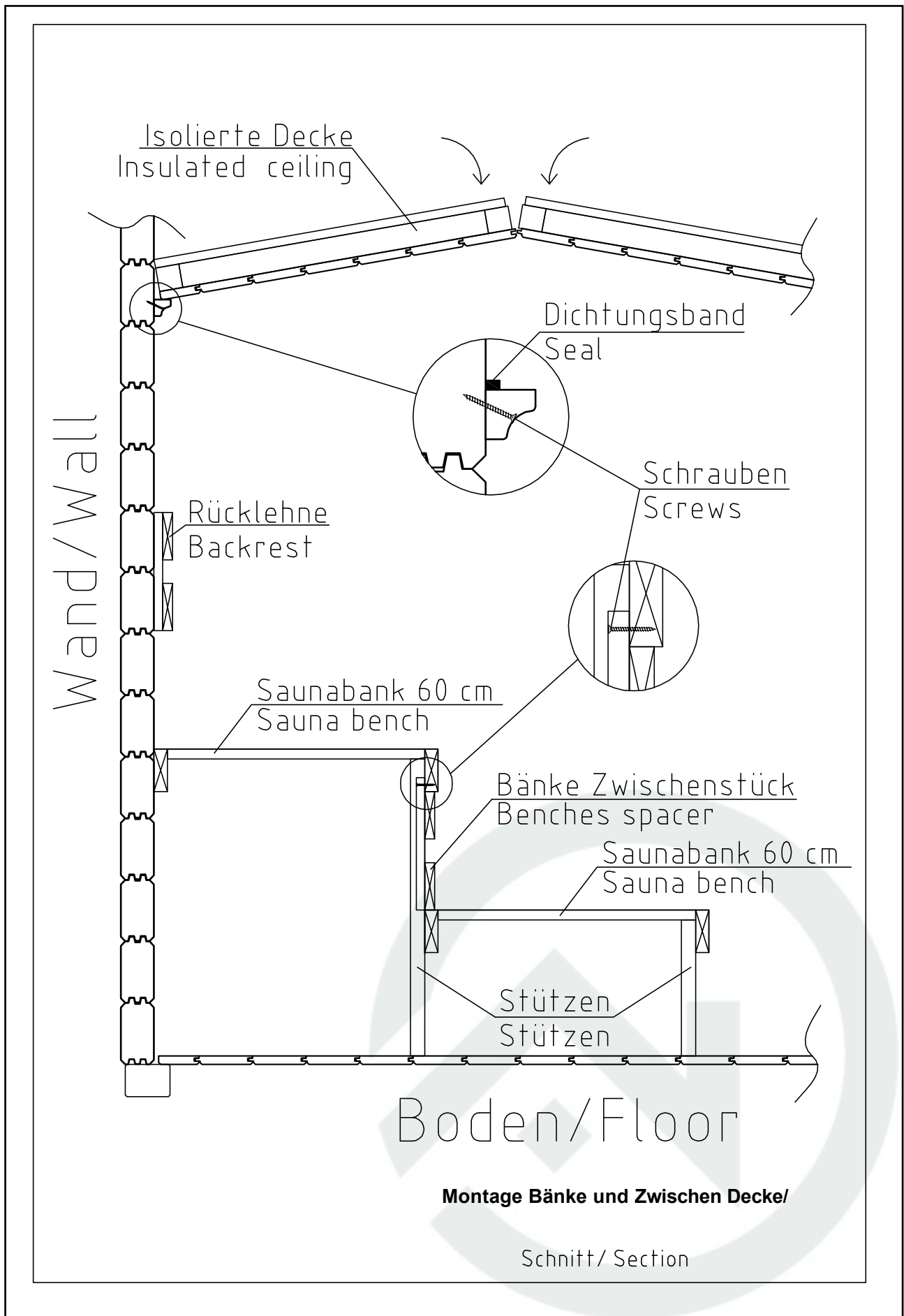

# Details 350150

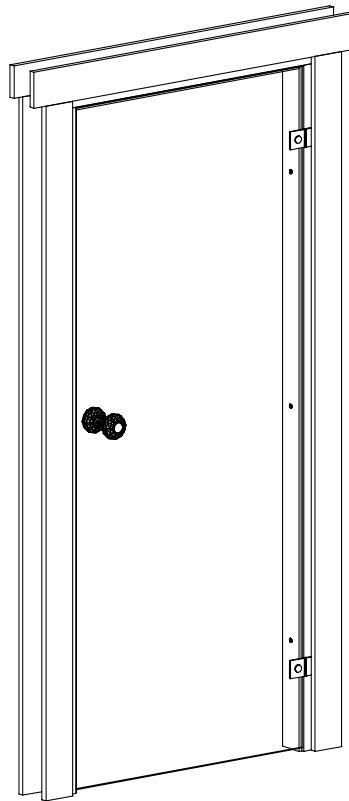

18x90 Blendleisten/  
cover strips/piirdeliistud

Rahmenleisten  
20x Wandstärke/  
frame extensions  
20x wall thickness/  
laiendusliist  
20x seina paksus

18x90 Blendleisten/  
cover strips/piirdeliistud

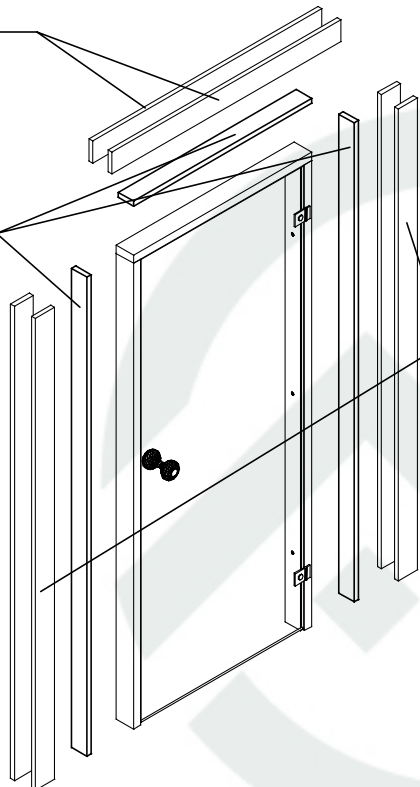

# Details 350150

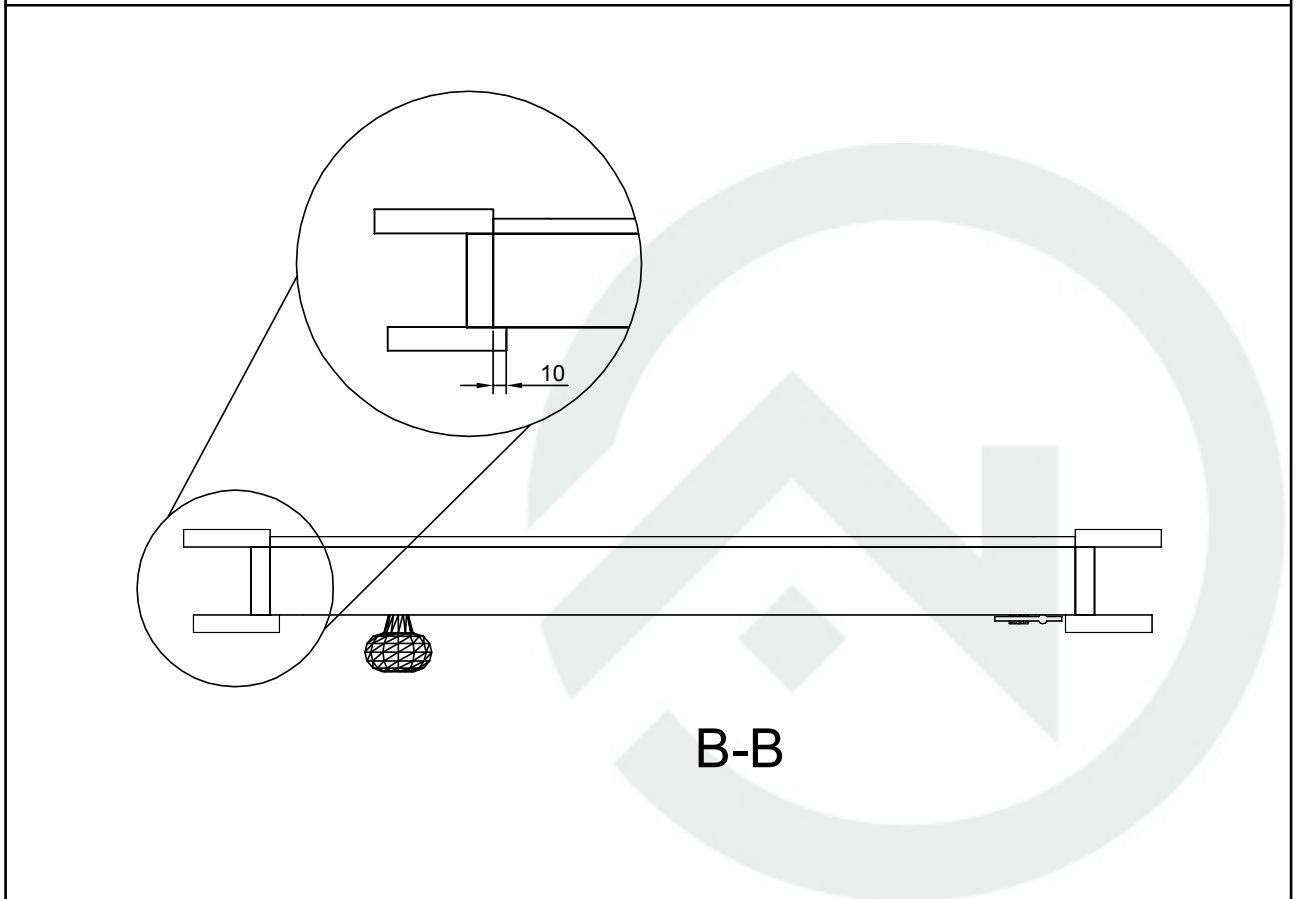
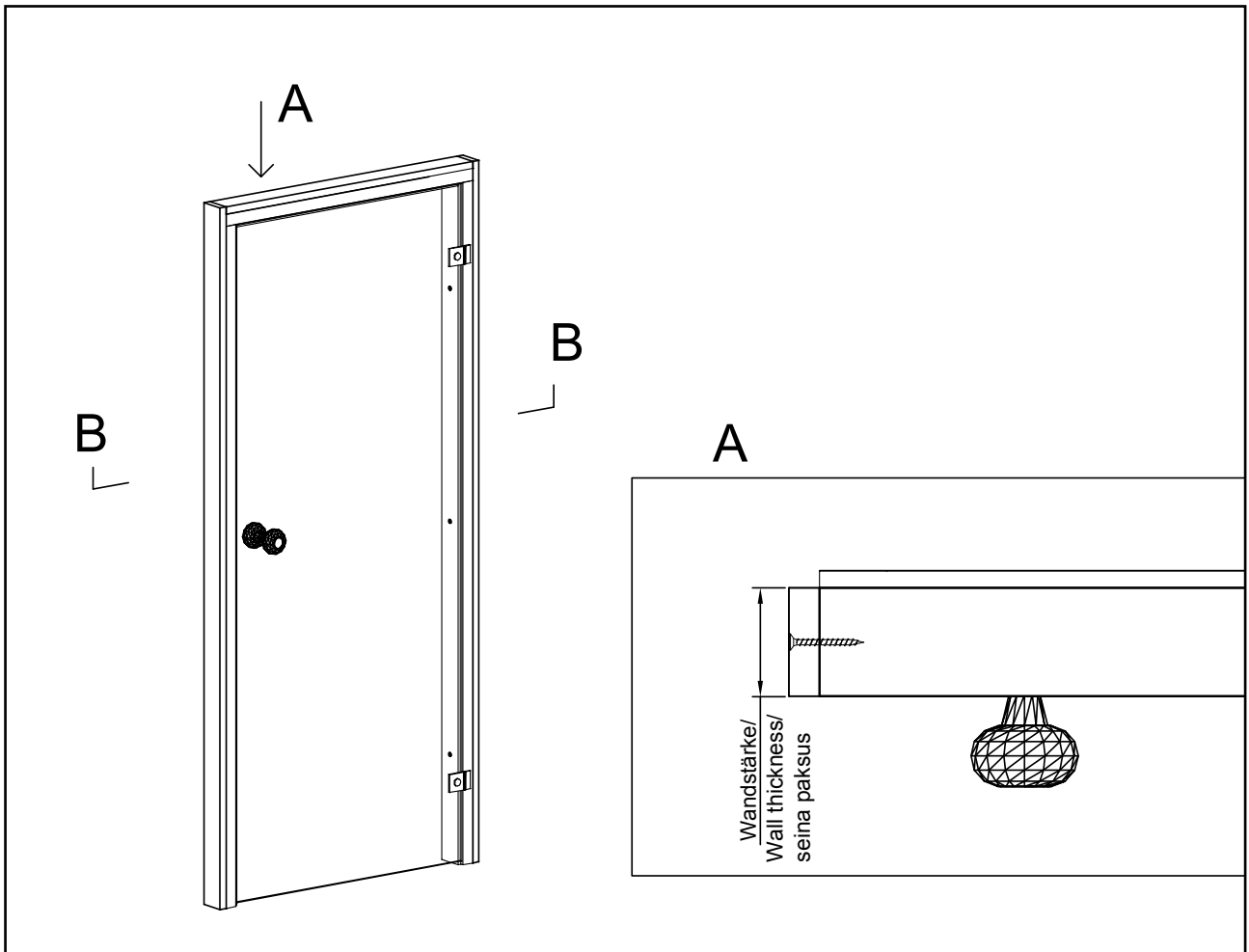

# Details 350150

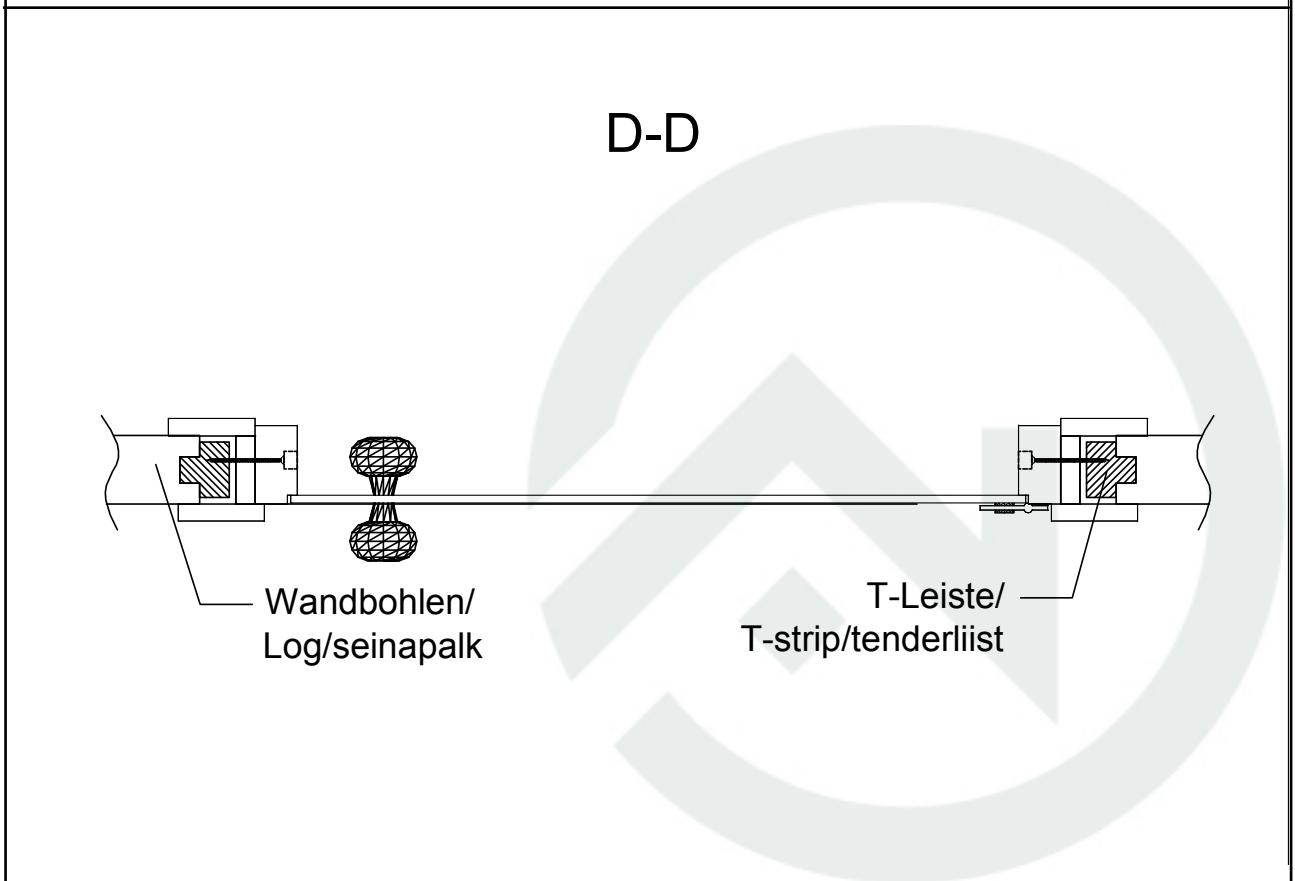
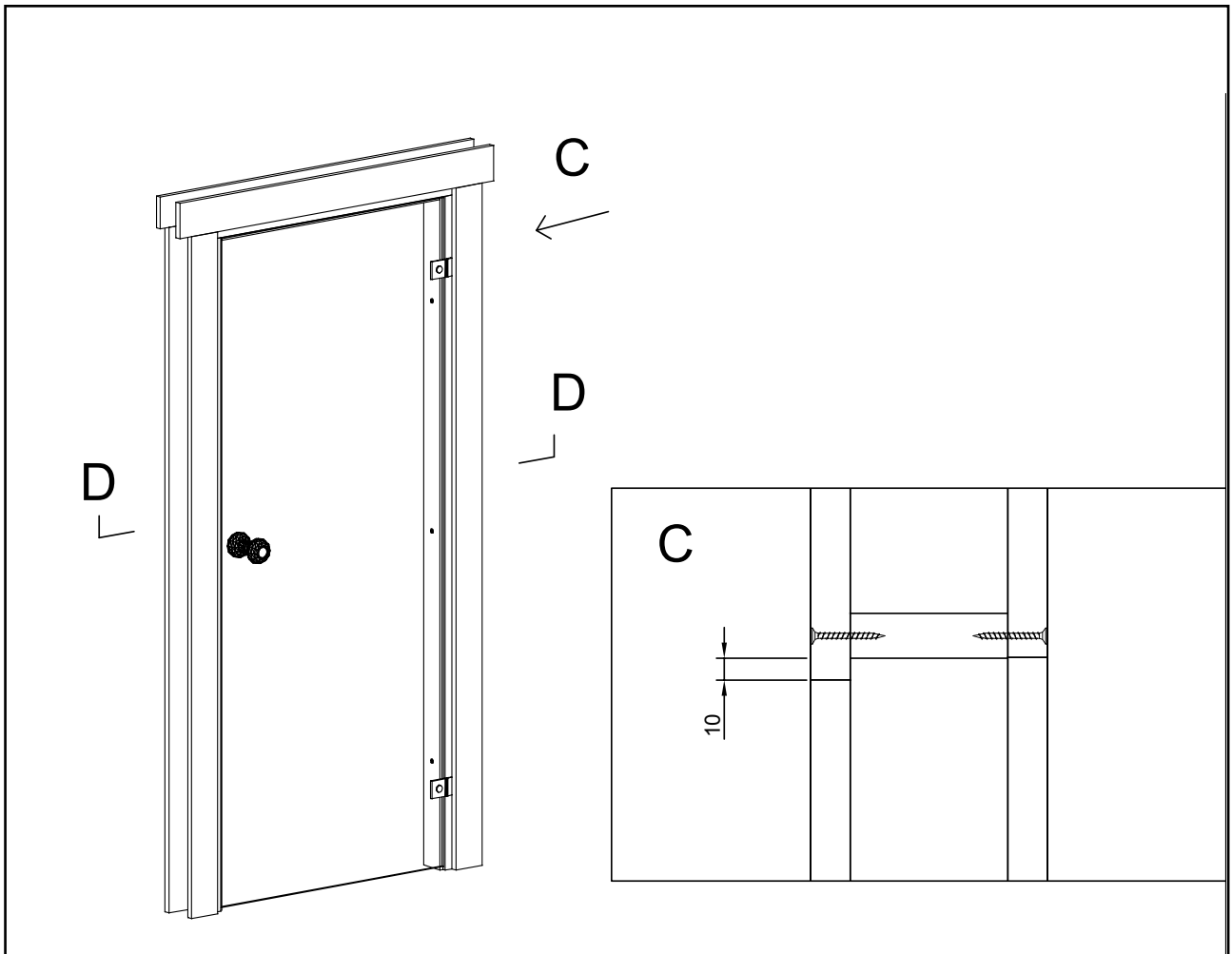

# Details 350150

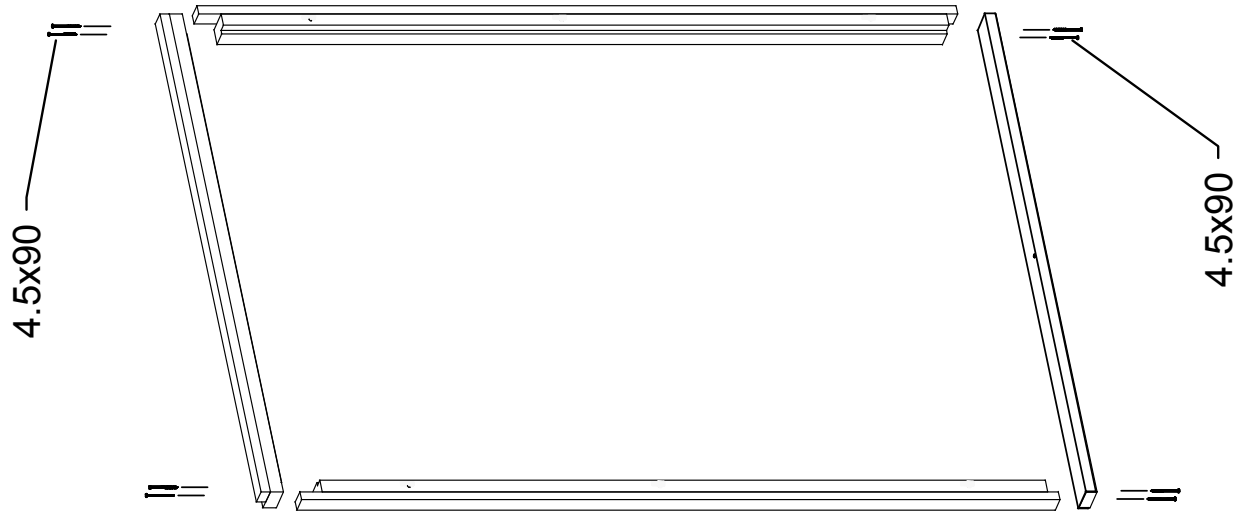

Ukse montaaž / Tür montage / Door assembly  
(GH+ / SH)

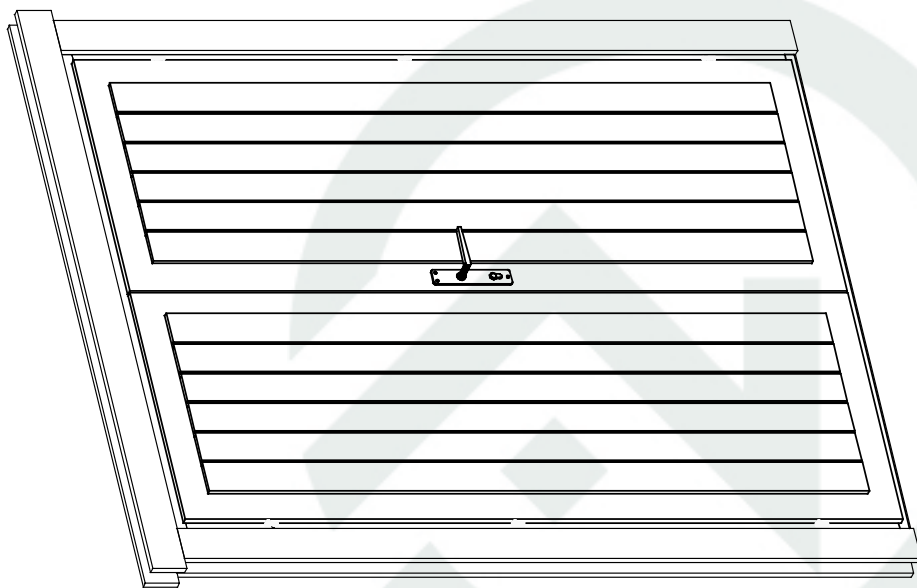

# Details 350150

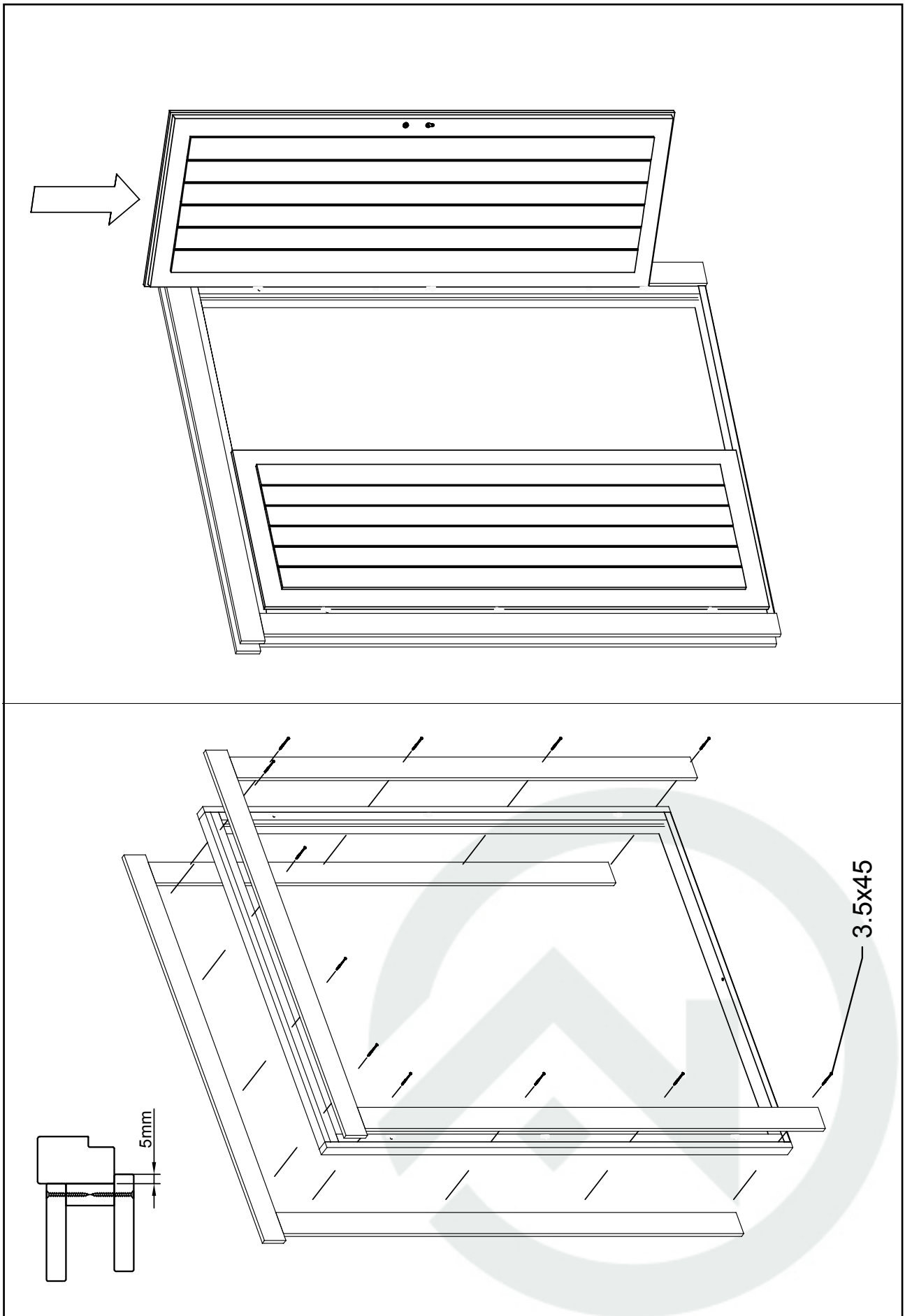

# Details 350150

