

# Technische Daten: Art.-Nr.: 300140

Wandaußenmaß: 300 x 300 cm

Bohlenstärke: 44 mm



Kontrolliert durch:

Empty box for signature or name.

Achtung: Alle angegebenen Maße sind ca.-Maße!

# 3D-Ansicht 300140

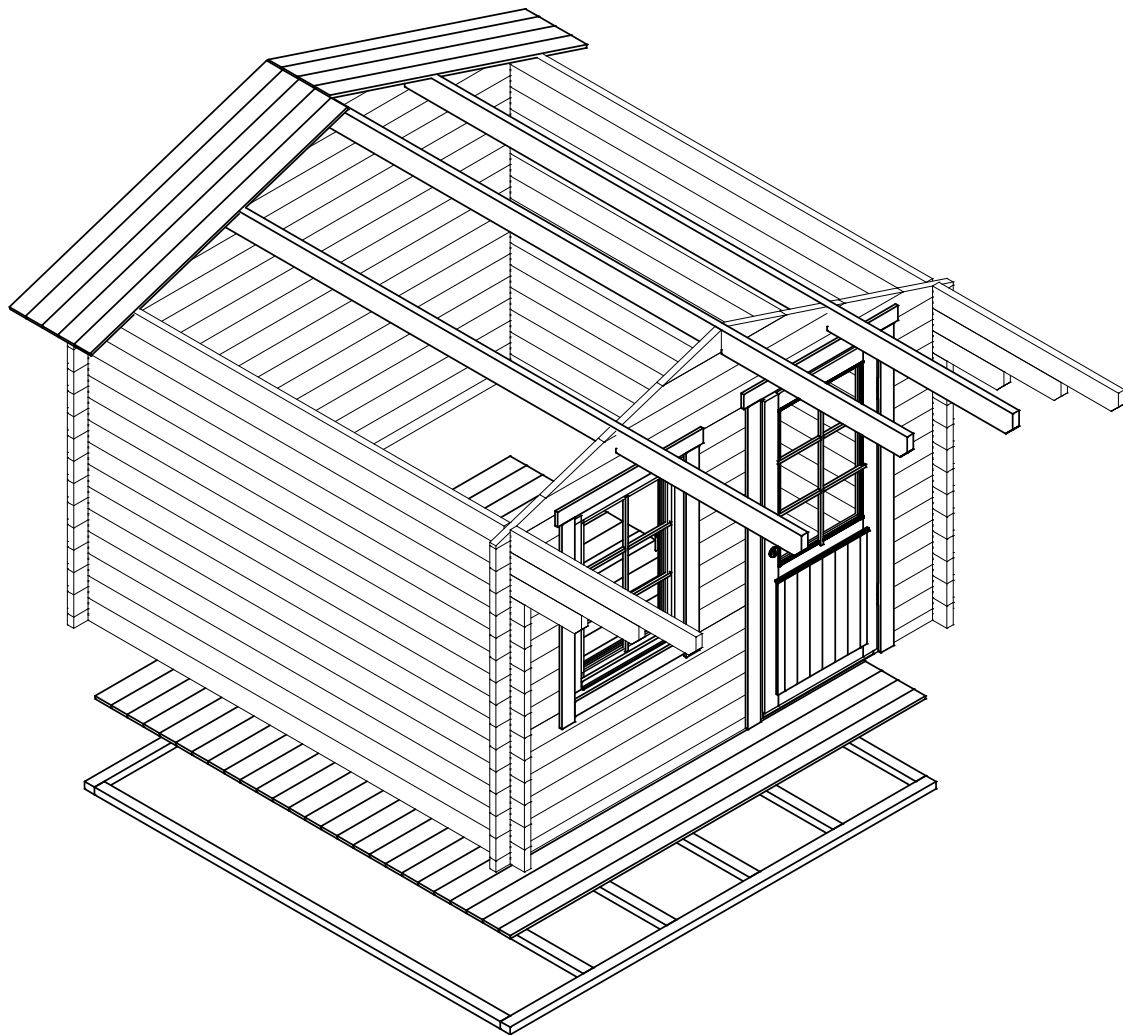







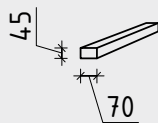
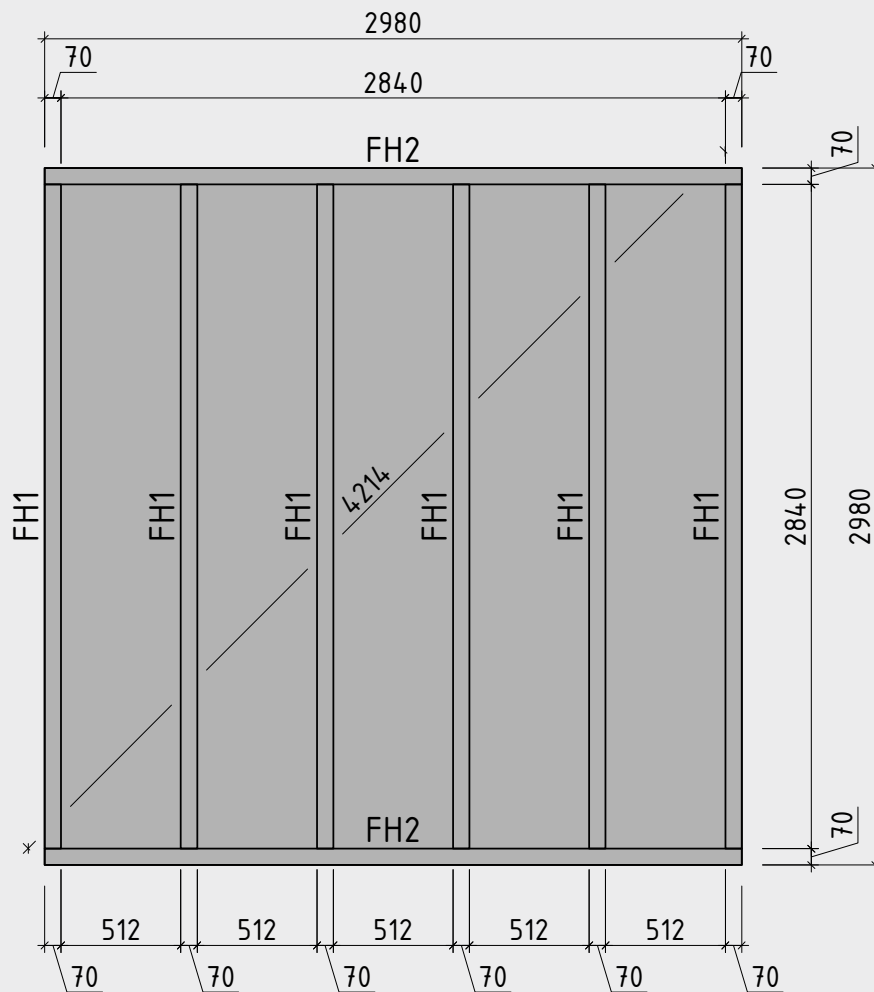





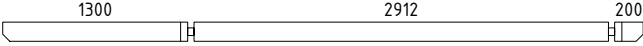

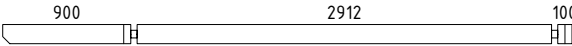
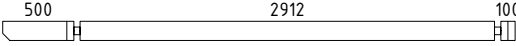
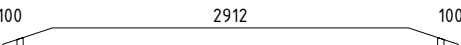
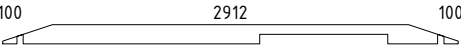
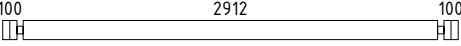
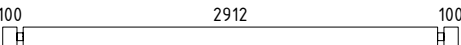
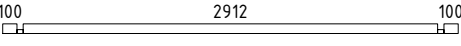

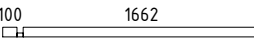
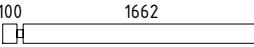
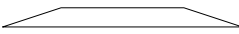

# Lagerholzplan und Fundamentplan 300140

Wir empfehlen als Fundament für Ihr Gartenhaus eine vollflächig, festgegründete gepflasterte oder betonierte Fläche.  
Wahlweise ist auch ein Punkt- oder Streifenfundament möglich.



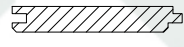









# Teilleiste 1

## 300140

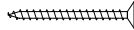
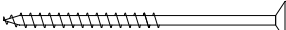
Pos		Stck.	Profil (mm)	Länge (mm)
001		1	44x135	4500
002		1	44x135	4500
003		2	44x135	4000
004		2	44x135	3600
005		1	44x135	3200
006		1	44x135	3200
007		24	44x135	3200
008		14	44x135	3200
009		1	44x68	3200
010		2	44x135	2502
011		1	44x68	1806
012		5	44x135	1806
013		2	44x135	1683
014		1	44x68	494
015		23	44x135	494
016		9	44x135	452
017		4	44x135	410
FH2	FUNDAMENTHÖLZER (imprägniert) 	2	70x45	2980
FH1	FUNDAMENTHÖLZER (imprägniert) 	6	70x45	2840
PF1		3	44x145	4500
	DACHBRETTER 	80+1	113x18	1895
	FUSSBODENBRETTER 	26+1	113x18	2905
	FUSSBODENLEISTE  ✓		18x40	12,0 lfdm
G02-1	GIEBELBRETTER 18x120  18,2° ✓	4	18x120	1975
G06-1	GIEBELDECKLEISTEN 18x58  ✓	4	18x58	1975

# Teileliste 2

## 300140

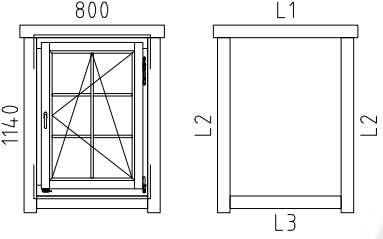
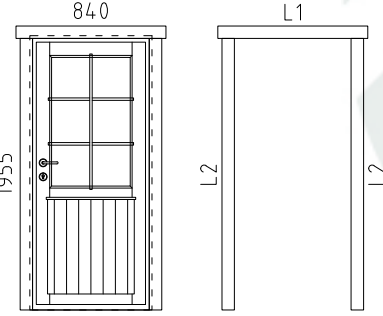
Pos			Stck.	Profil (mm)	Länge (mm)
T01-1	TRAUFENBRETTER 18x95		2	18x95	4500
T06-1	TRAUFENLEISTEN 18x40	 ✓		18x40	9,0 lfdm
GS	Giebelsegment		2		
NG04	NÄGEL 2.5x50	Dachbretter Fußbodenbretter		792	
SR32	SCHRAUBEN 3.0x30	Fußbodenleiste Traufenleiste 18x40		44	
SR37	SCHRAUBEN 3.5x45	Giebelleisten, Giebelbretter Traufenbretter, Giebelsegment Tür- und Fensterleisten		102	
SR57	SCHRAUBEN 5.0x100	Fundamenthölzer		32	
SH	Schlaghölzer		3		
KL1	Gewindestange M8		4		2000
KL2	Gewindestange M8		4		55
	Mutter M8 U-Scheibe Ø25		8		
	Befestigungsmutter M8		4		
	FENSTER <u>Q4</u>	W4-S44P-06C-08601140	1		
	 <p>A58-3/W118-PC</p> <p>L1 18x90 L=1040mm 2 Stck. L2 18x90 L=1260mm 4 Stck. L3 18x90 L=800mm 2 Stck. ✓</p>				
	TÜR <u>Q4</u>	D4-S44R-56C-08401955	1		
	 <p>U1-SH/D101-RC</p> <p>L1 18x90 L=1080mm 2x L2 18x90 L=1955mm 4x ✓</p> <p>DIN rechts</p>				
	✓ - bitte selber anpassen (falls nötig)!				









# Details 300140

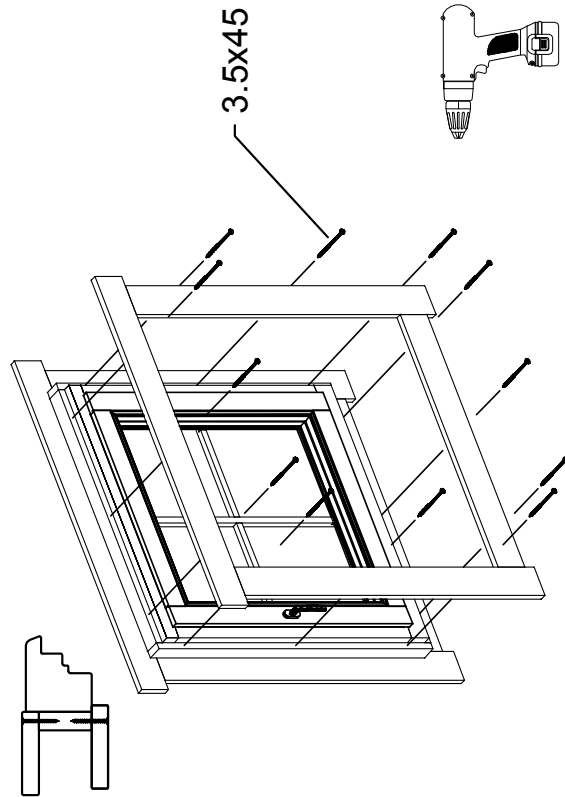
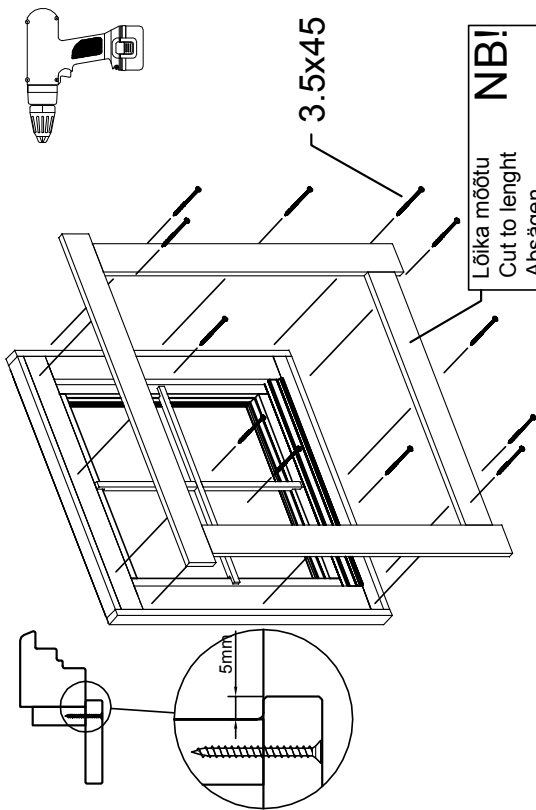

Akna tüüp / Fenster typ / Window type - A68  
(GH+ / SH)

