

# Technische Daten



Spiegelverkehrte Montage möglich. Durch Kunden farblich behandelt.

## Artikelnummer:

234 160

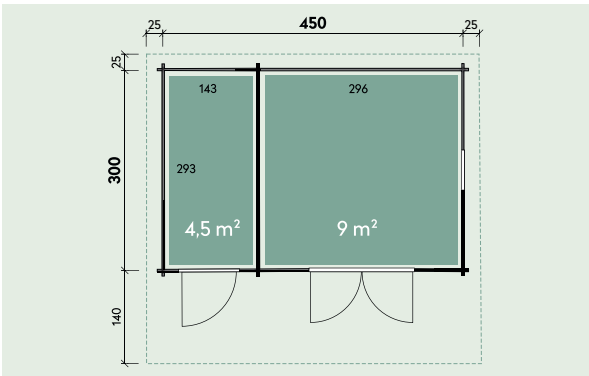

Kontrolliert durch:



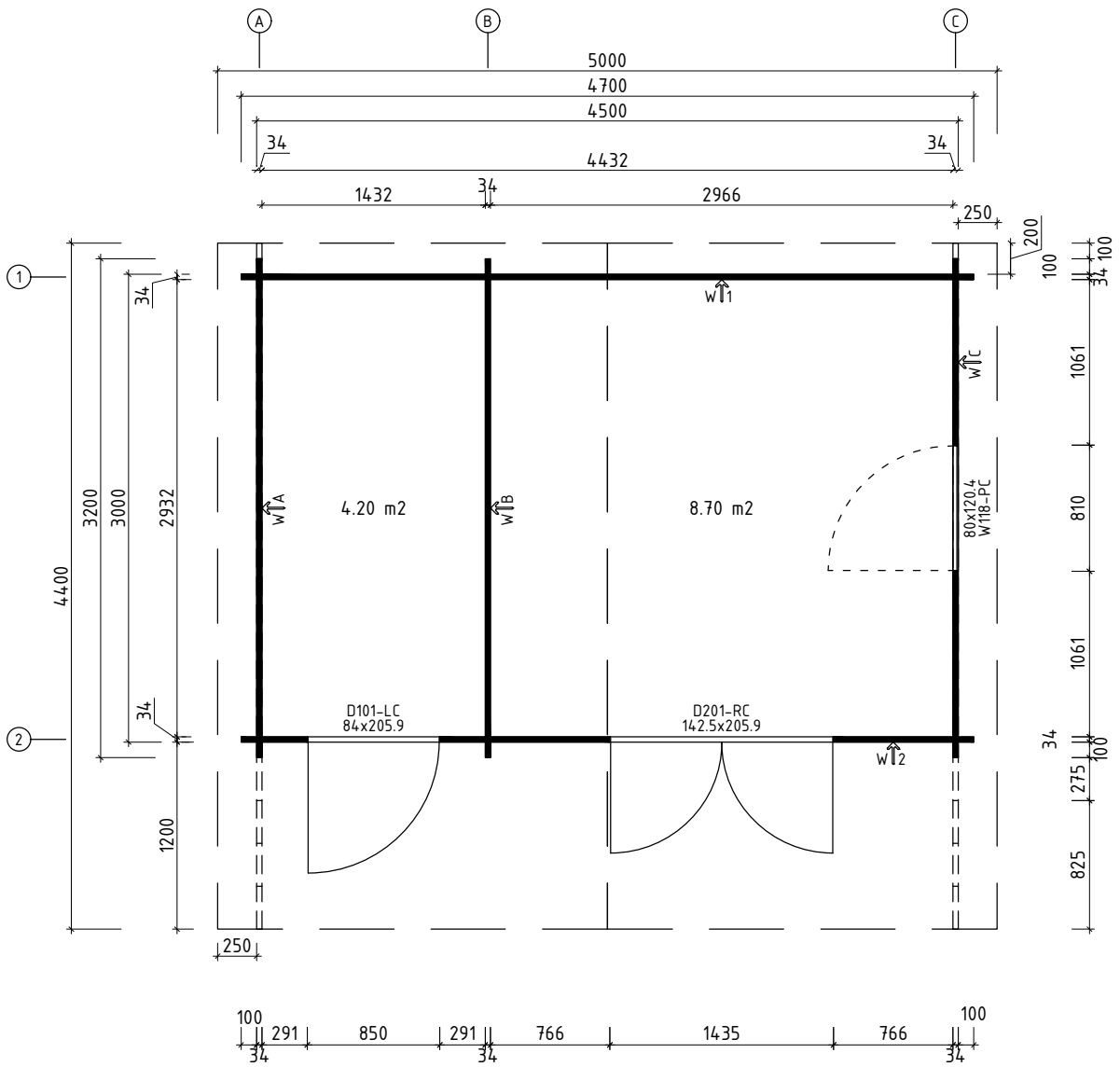



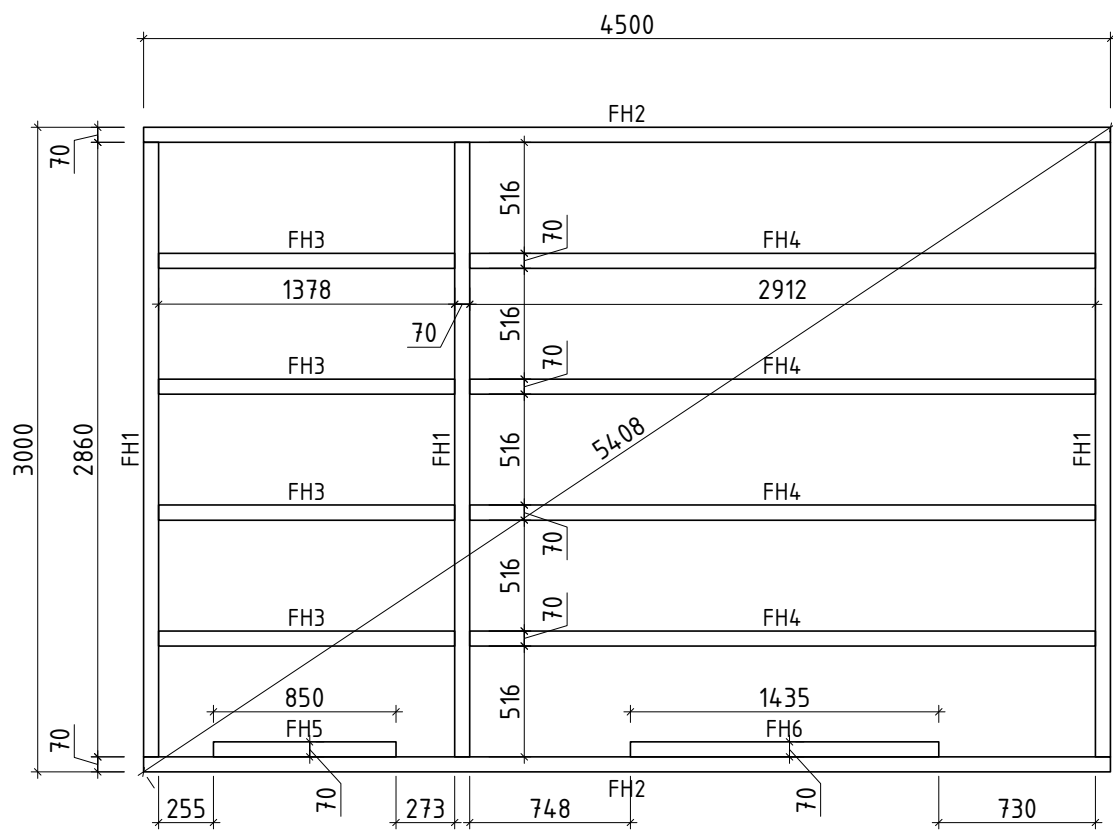



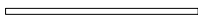

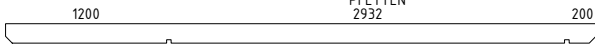

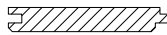









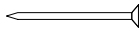



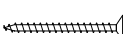

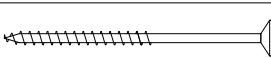
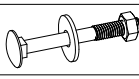

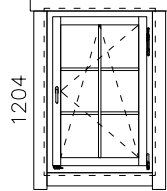
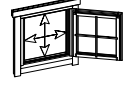









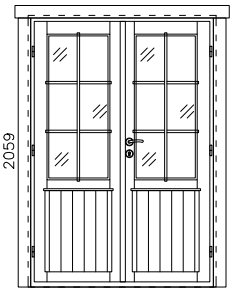
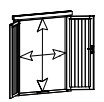
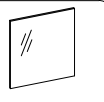

**Wir empfehlen als Fundament für Ihr Gartenhaus eine vollflächig festgegründete, gepflasterte oder betonierte Fläche. Wahlweise ist auch ein Punkt- oder Streifenfundament möglich.**





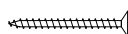



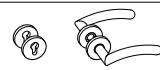

Pos		Stck	Profil (mm)	Länge (mm)
002		18	34x114	4700
003		1	34x57	4700
004		1	34x114	4400
005		1	34x114	4400
006		2	34x114	4025
008		1	34x114	3750
009		1	34x114	3475
010		43	34x114	3200
011		1	34x39	3200
014		1	34x114	1745
015		1	34x114	1470
017		20	34x114	1195
018		1	34x57	1090
019		18	34x114	1090
020		1	34x57	899
021		18	34x114	899
022		1	34x57	425
023		18	34x114	425
W1-1		1		
W2-1		1		
FH2	FUNDAMENTHÖLZER (imprägniert) 	2	70x45	4500
FH4	FUNDAMENTHÖLZER (imprägniert) 	4	70x45	2912
FH1	FUNDAMENTHÖLZER (imprägniert) 	3	70x45	2860

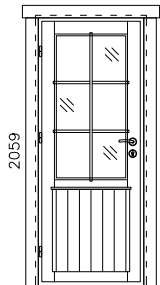
Pos		Stck	Profil (mm)	Länge (mm)
FH6	FUNDAMENTHÖLZER (imprägniert) 	1	70x45	1435
FH3	FUNDAMENTHÖLZER (imprägniert) 	4	70x45	1378
FH5	FUNDAMENTHÖLZER (imprägniert) 	1	70x45	850
PF1	PFETTEN 2932 	5	44x145	4400
	DACHBRETTER 	78+1	113x18	2585
	FUSSBODENBRETTER 	40+1	113x18	2925
	FUSSBODENLEISTEN  ✓		18x40	22.0lfm
G02-1	GIEBELBRETTER 18x120 14.6°  ✓	4	18x120	2665
G06-1	GIEBELDECKLEISTEN 18x58  ✓	4	18x58	2665
T06-1	TRAUFELEISTEN 18x40  ✓		18x40	9.0lfm
T01-1	TRAUFENBRETTER 18x95 	2	18x95	4400
SM-1	Sturmleisten 	4	18x40	2052
GS	Giebelsegment 	2		
SH	Schlaghölzer 	3		
NG2 550	NÄGEL 2.5x50 Dachbretter 	624		
NG2 550	NÄGEL 2.5x50 Fussbodenbretter 	480		
SR3 030	SCHRAUBEN 3.0x30 Fussbodenleisten 	45		
SR3 030	SCHRAUBEN 3.0x30 Traufenleisten 	18		
SR3 545	SCHRAUBEN 3.5x45 Giebelbretter 	24		
SR3 545	SCHRAUBEN 3.5x45 Giebeldeckleisten 	24		
SR3 545	SCHRAUBEN 3.5x45 Giebelsegment 	4		
SR3 545	SCHRAUBEN 3.5x45 Traufenbretter 	18		
SR5 0100	SCHRAUBEN 5.0x100 Fundamenthölzer 	60		
SS024	Schloßschrauben M8x70 Mutter M8 U-Scheibe Ø25 - Befestigung für Sturmleisten 	12		

Pos		Stck	Profil (mm)	Länge (mm)
	<p style="text-align: center;"><b>FENSTER 800x1204</b> W4-S34P-06C-08001204</p> <div style="display: flex; justify-content: space-between; align-items: flex-start;"> <div style="text-align: center;"> <p><b>Q4</b> W118-PC 800</p>  <p style="transform: rotate(-90deg); position: absolute; left: -40px; top: 50px;">1204</p> </div> <div style="border: 1px solid black; padding: 5px; width: 180px;"> <p>Right handed / DIN rechts / paremakäeline</p> <hr/> <p>Clear opening/ durchgangsmaß/ ava suurus 644x1031mm</p> <div style="text-align: center;">  </div> <hr/> <p>double-pane clear float glass</p> <p>ISO Glas 2-fach</p> <p>2x klaaspakett, kirgas klaas</p> <div style="text-align: center;">  <p>585x979mm</p> </div> </div> </div>	1		
VP54 32-1	Q4 Window sill - Fensterbank - Veeplekk 	1		642
PROSS H41-1	Q4-1 Muntins - Sprossen - Prossid horizontal 18x18 	2	18x18	610
PROSS V42-1	Q4-2 Muntins - Sprossen - Prossid vertical 18x18 	1	18x18	1014
PL3-1	Trims - Rahmenleisten - Piirdeliistud 18x95  ✓	2	18x95	1000
PL3-2	Trims - Rahmenleisten - Piirdeliistud 18x95  ✓	4	18x95	1285
PL3-3	Trims - Rahmenleisten - Piirdeliistud 18x95  ✓	2	18x95	760
SR30 22-01	3.0x20ÜP Muntins - Sprossen - Prossid 	6		
SR35 45-01	3.5x45 Trims - Rahmleisten - Piirdeliistud 	24		
AL-Q4	Q4 Window handle - Fenstergriff - Aknalink 	1		

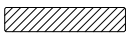
Pos		Stck	Profil (mm)	Länge (mm)	
	<p style="text-align: center;"><b>TÜR 1425x2059</b> <b>D4-D34R-56C-14252059</b></p> <p><b>Q4 D201-RC</b> 1425</p>  <div style="display: flex; justify-content: space-between;"> <div style="width: 45%;"> <p>Right handed / DIN rechts / paremakäeline</p> <p>Clear opening/ durchgangsmaß/ ava suurus 1297x1951mm</p> <p>double-pane clear float glass ISO Glas 2-fach 2x klaaspakett, kingas klaas</p> </div> <div style="width: 45%;">   <p>472x1100mm</p> </div> </div>	1			
PROSS H41-2	Q4-1 Muntins - Sprossen - Prossid horizontal 18x18		4	18x18	497
PROSS V42-2	Q4-2 Muntins - Sprossen - Prossid vertical 18x18		2	18x18	1125
PL3-4	Trims - Rahmenleisten - Piirdeliistud 18x95	 ✓	4	18x95	2039
PL3-5	Trims - Rahmenleisten - Piirdeliistud 18x95	 ✓	2	18x95	1625
SR30 20-01	3.0x20 Locking plate - Schließblech - Riivi vastus 02 Q4-Q5		2		
SR30 22-01	3.0x20ÜP Muntins - Sprossen - Prossid		12		
SR35 45-01	3.5x45 Trims - Rahmleisten - Piirdeliistud		24		
SR50 90-01	5.0x90 Door frames - Türrahmen - Ukselengid		8		
RV02	Locking plate - Schließblech - Riivi vastus 02 Q4-Q5		1		
LS-Q4	Q4 Cylinder lock - Zylinderschloss - Lukusüdamik		1		
UL-Q4	Q4 Door handle - Türgriff - Ukselink		1		

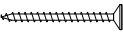

Pos		Stck	Profil (mm)	Länge (mm)	
	<p><b>TÜR 840x2059</b> D4-S34L-56C-08402059</p> <p>Q4 D101-LC 840</p>  <p>Left handed / DIN links / vasakukäeline</p> <p>Clear opening/ durchgangsmaß/ ava suurus 712x1951mm</p>  <p>double-pane clear float glass ISO Glas 2-fach 2x klaaspakett, kirkas klaas</p>  <p>549x1100mm</p>	1			
PROSS H41-3	Q4-1 Muntins - Sprossen - Prossid horizontal 18x18		2	18x18	574
PRO SS V42-2	Q4-2 Muntins - Sprossen - Prossid vertical 18x18		2	18x18	1125
PL3-4	Trims - Rahmenleisten - Piirdeliistud 18x95	 ✓	4	18x95	2039
PL3-6	Trims - Rahmenleisten - Piirdeliistud 18x95	 ✓	2	18x95	1040
SR30 22-01	3.0x20ÜP Muntins - Sprossen - Prossid		6		
SR35 45-01	3.5x45 Trims - Rahmleisten - Piirdeliistud		22		
LS-Q4	Q4 Cylinder lock - Zylinderschloss - Lukusüdamik		1		
UL-Q4	Q4 Door handle - Türgriff - Ukselink		1		

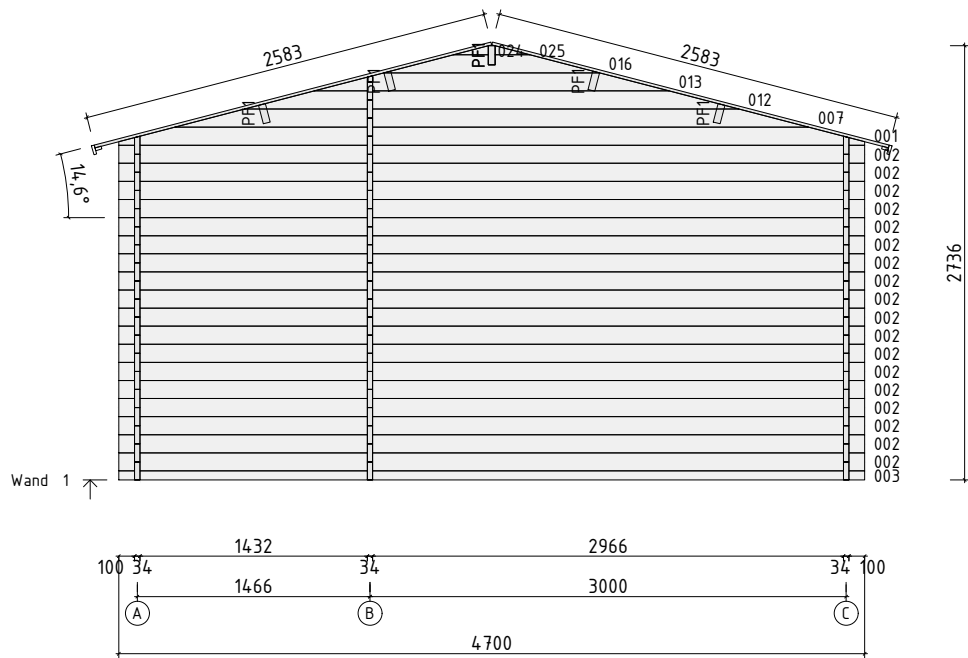

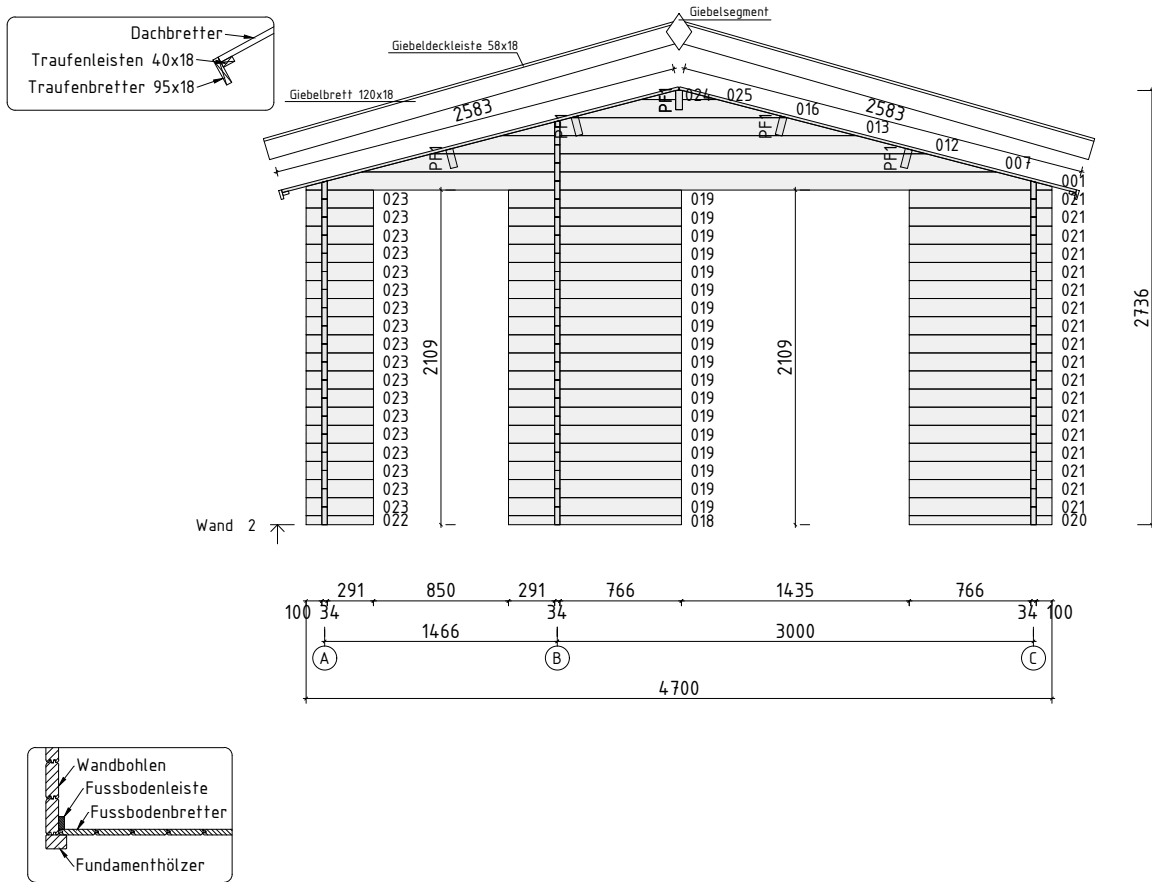

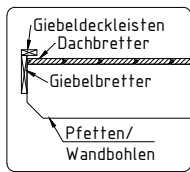

Wand A ↗

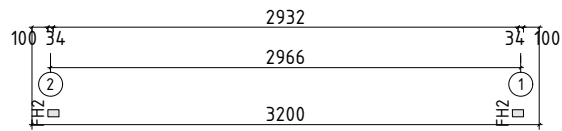
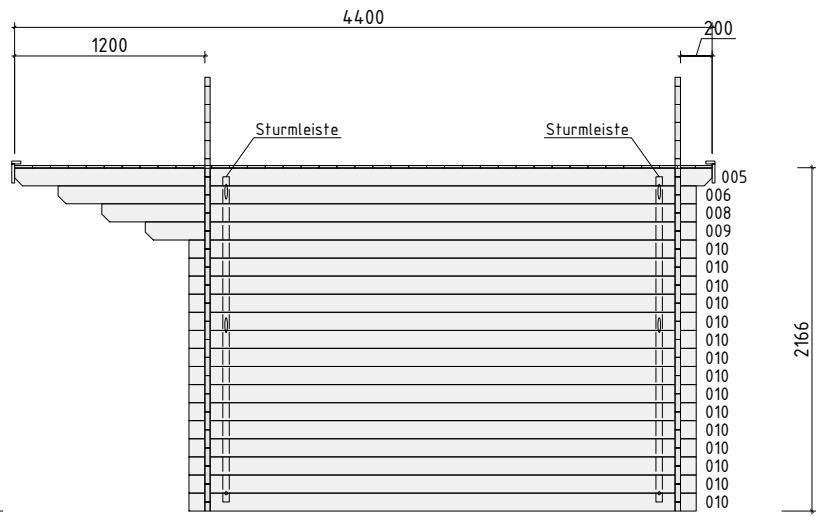

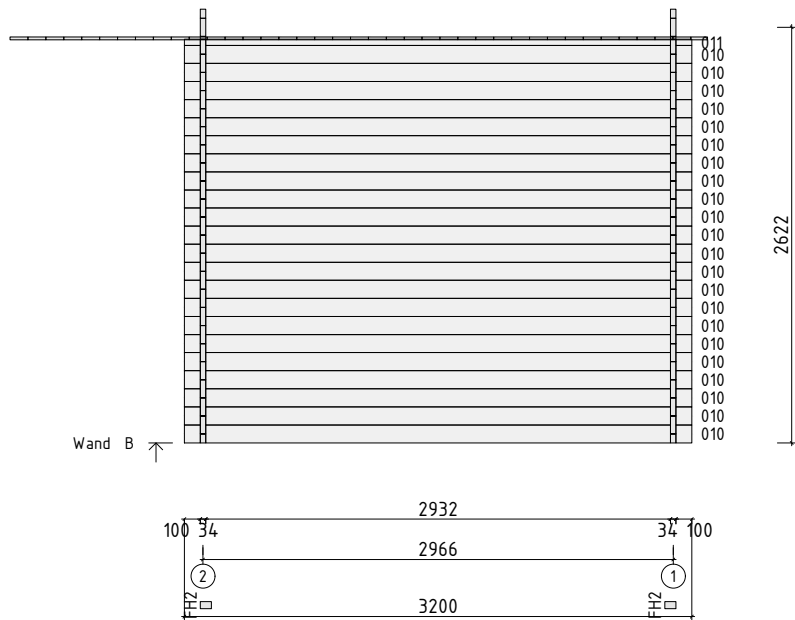

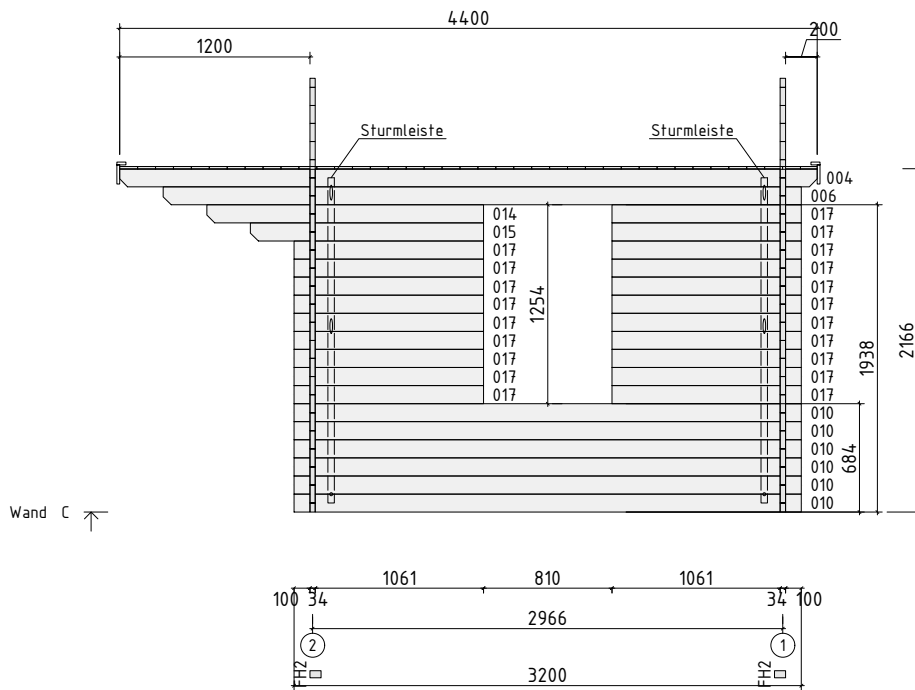

Aken Q4-Q6 - paigaldusjuhhis  
 Window Q4-Q6 - assembly instructions  
 Fenster Q4-Q6 - Montageanleitung

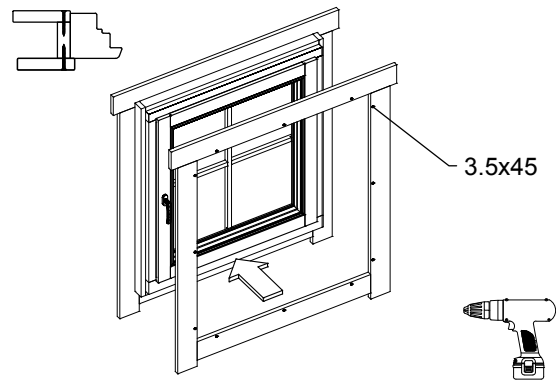
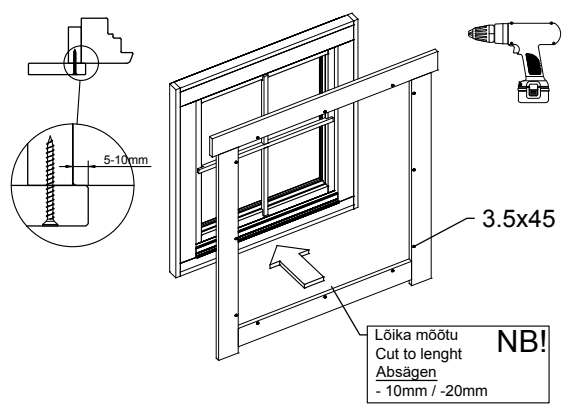
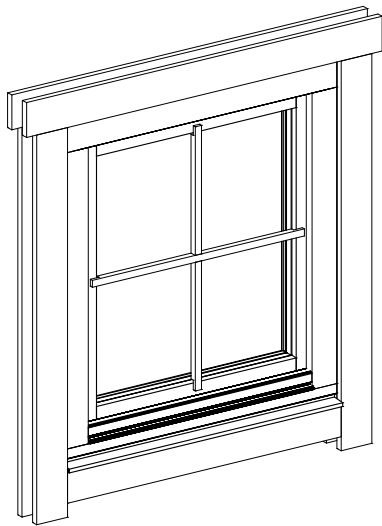

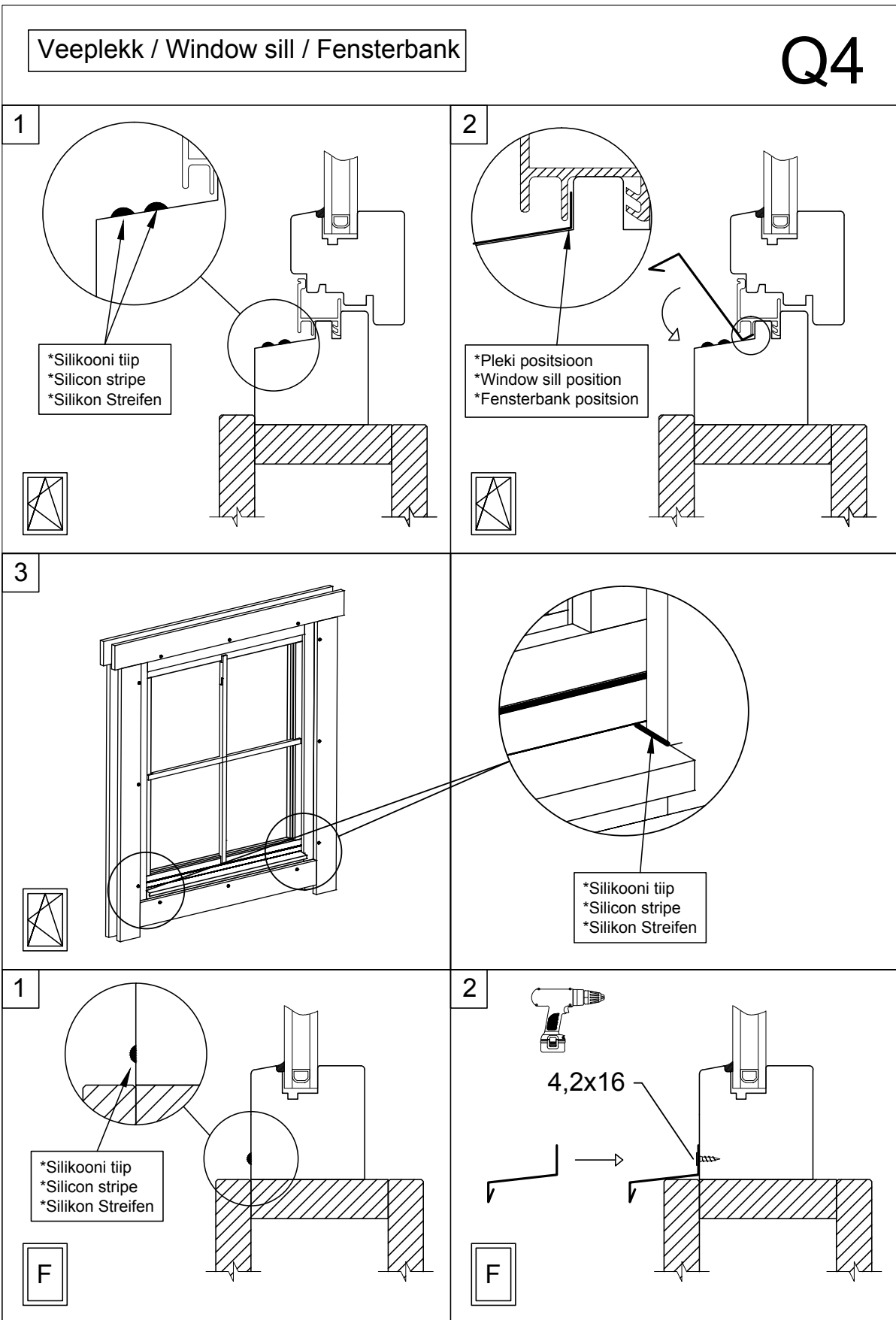



Ukse montaaž / Tür montage / Door assembly  
(GH+ / SH)

