

Technische Daten

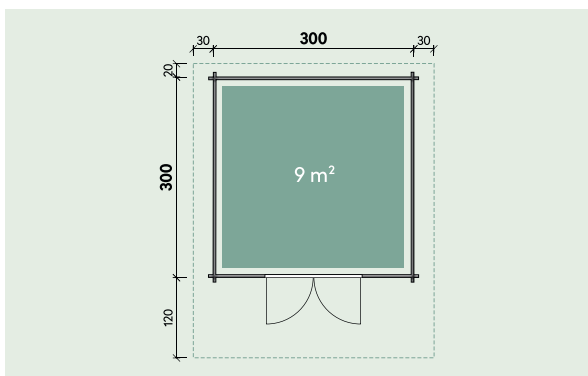

Artikelnummer:

234 060 ist Bestandteil von
830 251, 830 252, 830 253, 830 254



Kontrolliert durch:

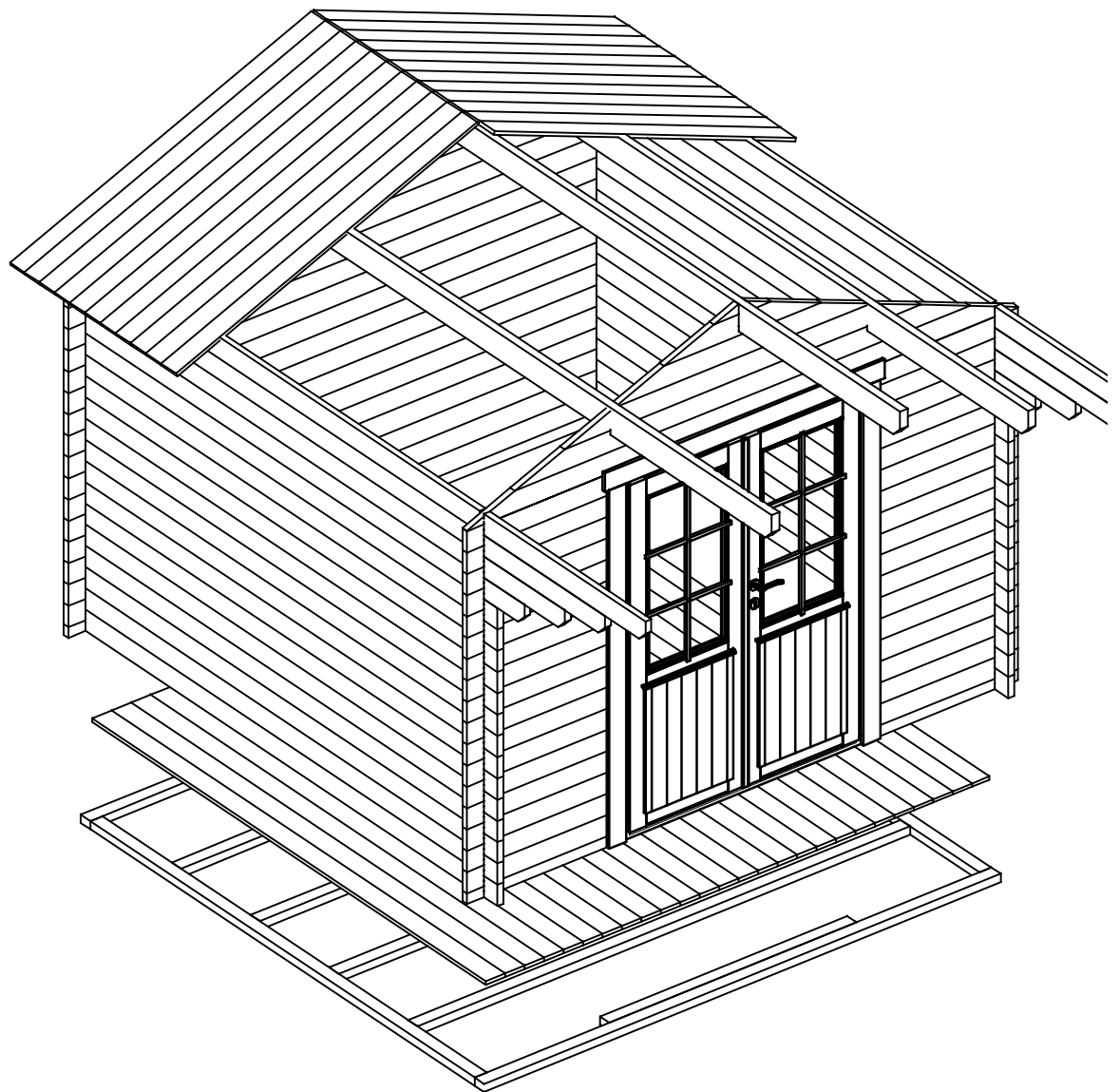

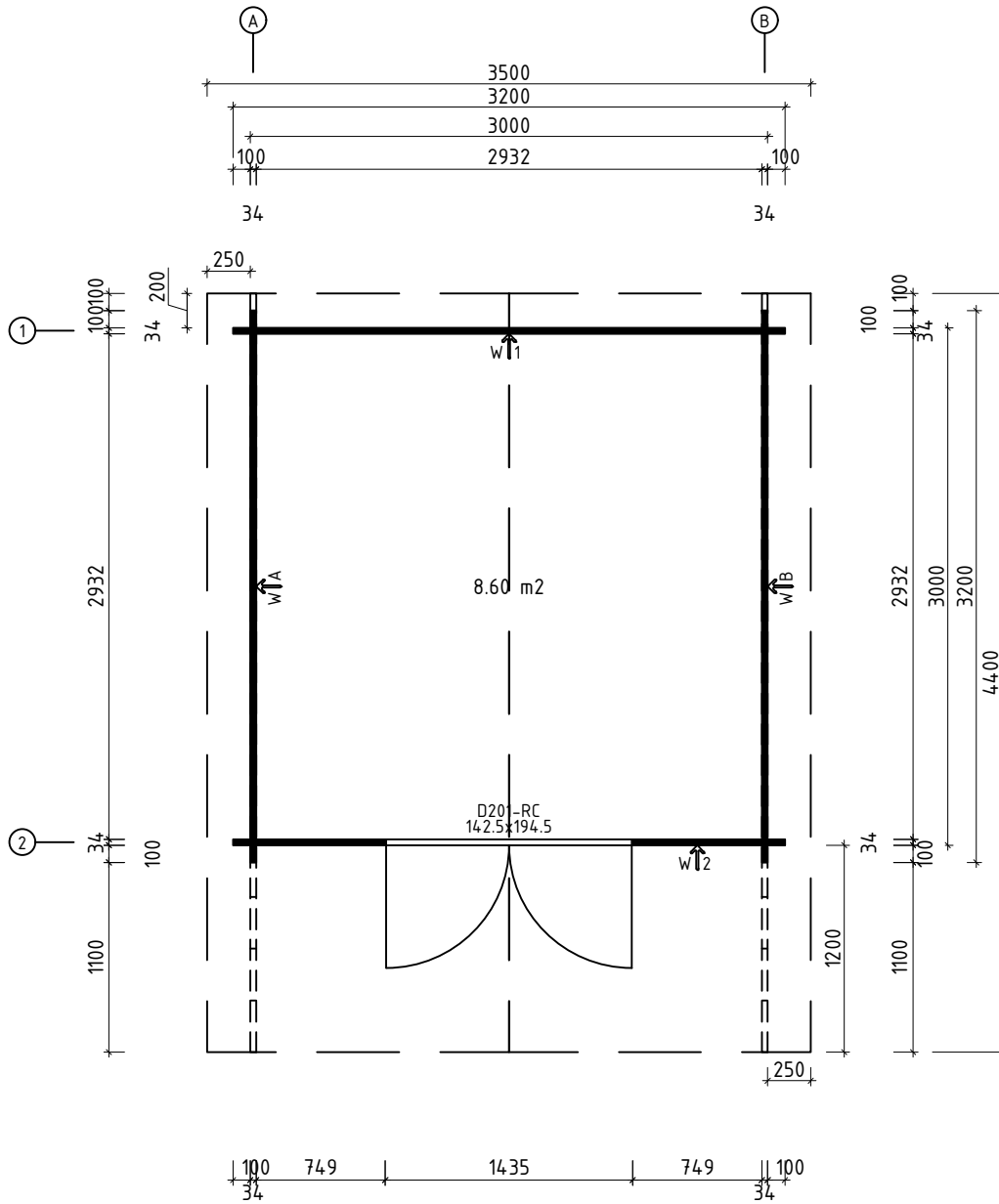



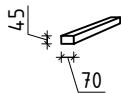
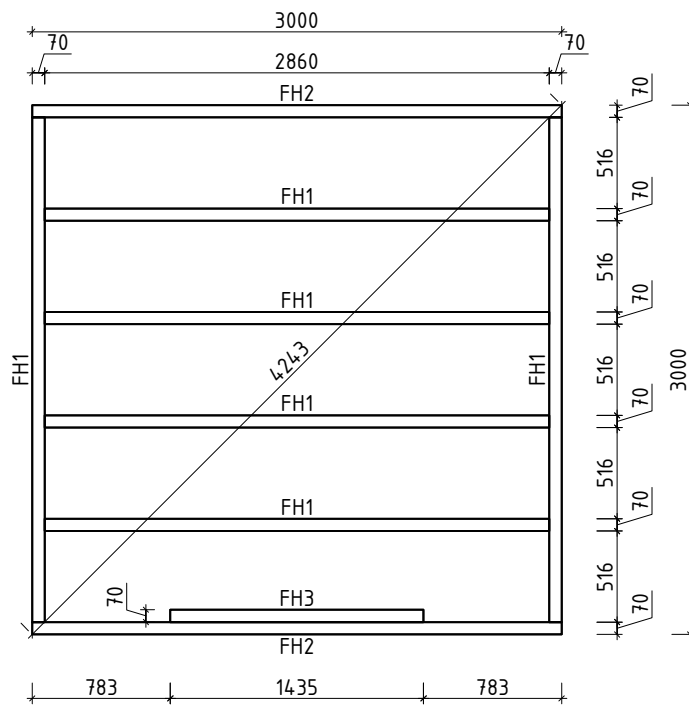



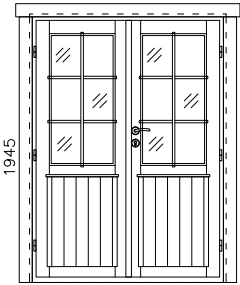



Wir empfehlen als Fundament für Ihr Gartenhaus eine vollflächig festgegründete, gepflasterte oder betonierte Fläche. Wahlweise ist auch ein Punkt- oder Streifenfundament möglich.

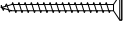
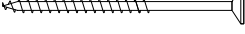

Nr.		Stck	Profil (mm)	Länge (mm)
001		1	34x114	4400
002		1	34x114	4400
003		2	34x114	4000
004		2	34x114	3700
005		2	34x114	3400
007		45	34x114	3200
008		1	34x57	3200
013		2	34x57	883
014		34	34x114	883
W1-1		1		
W2-1		1		
FH2	FUNDAMENTHÖLZER (imprägniert) 	2	70x45	3000
FH1	FUNDAMENTHÖLZER (imprägniert) 	6	70x45	2860
FH3	FUNDAMENTHÖLZER (imprägniert) 	1	70x45	1435
PF1	PFETTEN 2932 	2	44x145	4400
PF2	PFETTEN 2932 	1	44x145	4400
	DACHBRETTER	78+1	113x18	1880
	FUSSBODENBRETTER	26+1	113x18	2925
	FUSSBODENLEISTEN		18x40	13.0lfm
G02-1	GIEBELBRETTER 18x120	4	18x120	1960
G06-1	GIEBELDECKLEISTEN 18x58	4	18x58	1960
T06-1	TRAUFENLEISTEN 18x40		18x40	9.0lfm
T01-1	TRAUFENBRETTER 18x95	2	18x95	4400

Nr.		Stck	Profil (mm)	Länge (mm)
	<p style="text-align: center;">TÜR 1425x1945 D4-D34R-56C-14251945</p> <p>Q4 D201-RC 1425</p>  <div style="border: 1px solid black; padding: 5px; margin-top: 10px;"> <p>Right handed / DIN rechts / paremakäeline</p> <p>Clear opening / durchgangsmaß / ava suurus 1297x1837mm</p> <p>double-pane clear float glass ISO Glas 2-fach 2x klaaspakett, kirkas klaas 472x950mm</p> </div>	1		
PROSS H41-1	Q4-1 Muntins - Sprossen - Prossid horizontal 18x18 	4	18x18	497
PROSS V42-1	Q4-2 Muntins - Sprossen - Prossid vertical 18x18 	2	18x18	975
PL3-1	Trims - Rahmenleisten - Piirdeliistud 18x95  ✓	4	18x95	1925
PL3-2	Trims - Rahmenleisten - Piirdeliistud 18x95  ✓	2	18x95	1625
SR30 20-01	3.0x20 Locking plate - Schließblech - Riivi vastus 02 Q4-Q5 	2		
SR30 22-01	3.0x20ÜP Muntins - Sprossen - Prossid 	12		
SR35 45-01	3.5x45 Trims - Rahmleisten - Piirdeliistud 	24		
SR50 90-01	5.0x90 Door frames - Türrahmen - Ukselengid 	8		
RV02	Locking plate - Schließblech - Riivi vastus 02 Q4-Q5 	1		
LS-Q4	Q4 Cylinder lock - Zylinderschloss - Lukusüdamik 	1		
UL-Q4	Q4 Door handle - Türgriff - Ukselink 	1		

