

# Technische Daten

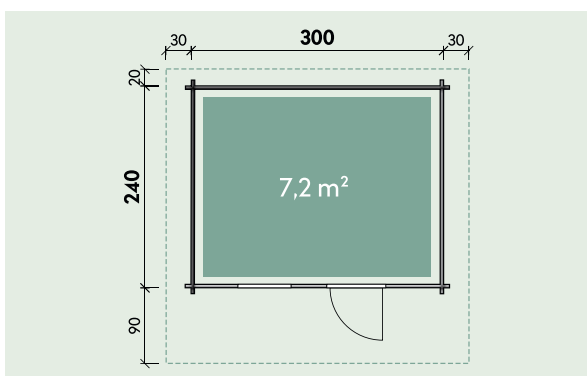

## Artikelnummer:

234 030



**Kontrolliert durch:**

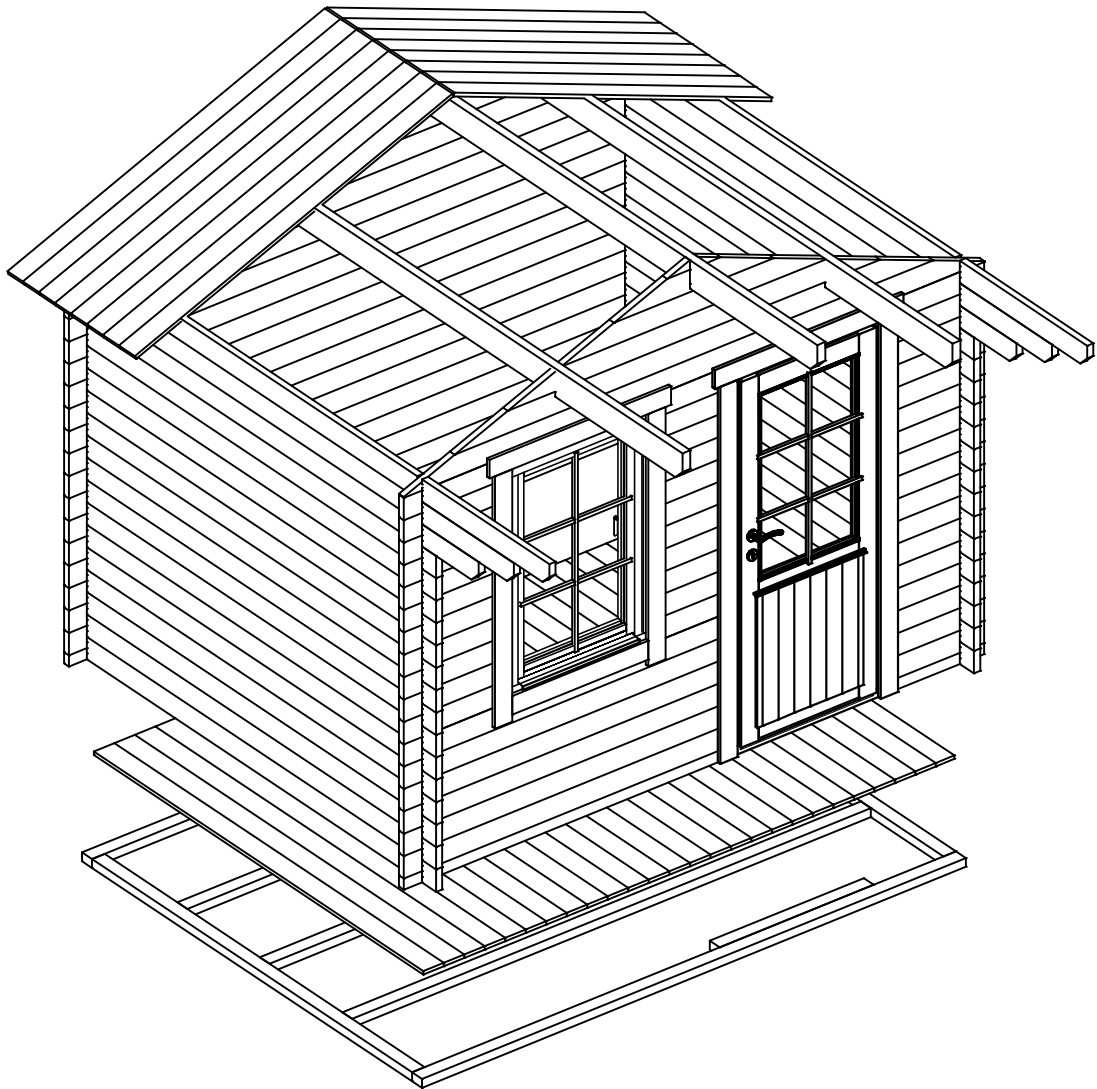

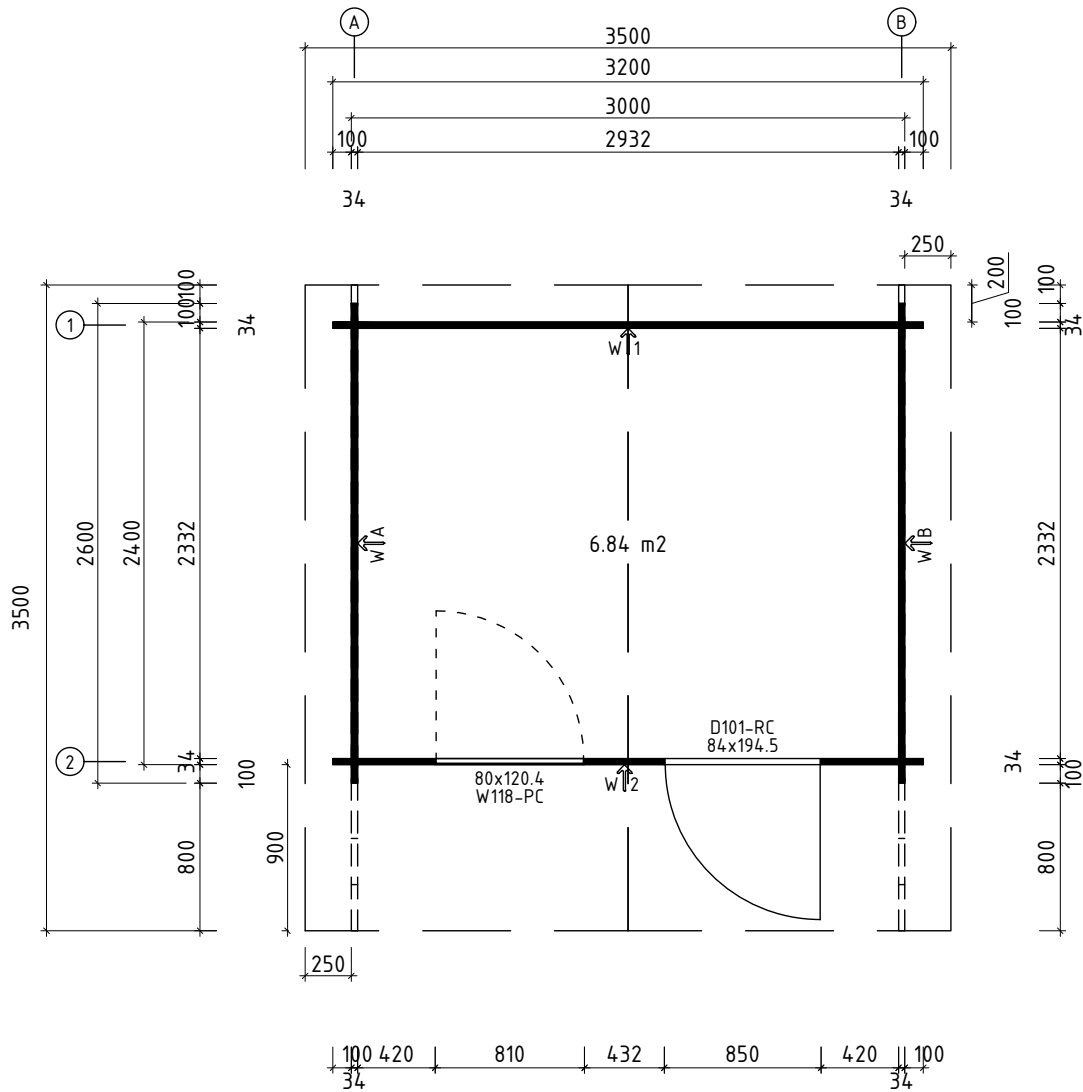







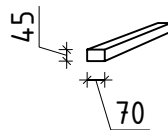
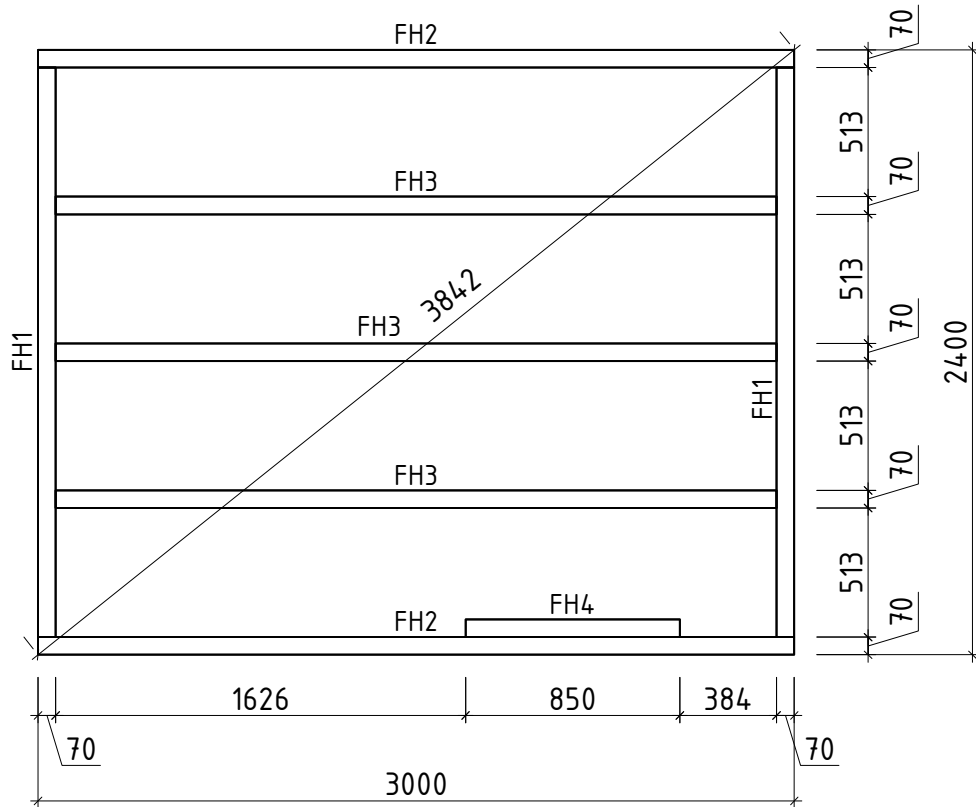







\*Fenster und Türen sind mit Sprossen



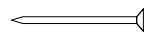



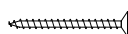

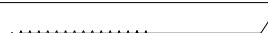
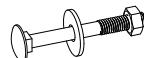

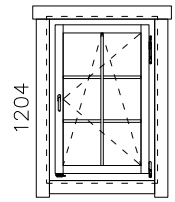
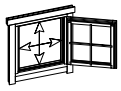
**Q4** – Qualitätsklasse für Fenster und Türen







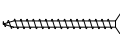

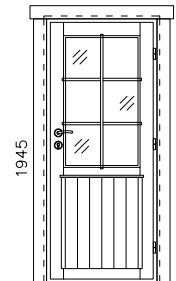

**Wir empfehlen als Fundament für Ihr Gartenhaus eine vollflächig festgegründete, gepflasterte oder betonierte Fläche. Wahlweise ist auch ein Punkt- oder Streifenfundament möglich.**

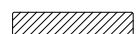

Nr.		Stck	Profil (mm)	Länge (mm)
001		1	34x114	3500
002		1	34x114	3500
004		17	34x114	3200
005		1	34x57	3200
006		2	34x114	3150
007		2	34x114	2900
009		30	34x114	2600
011		1	34x57	1796
012		6	34x114	1796
015		28	34x114	554
016		1	34x57	554
017		11	34x114	432
W1-1		1		
W2-1		1		
FH2	FUNDAMENTHÖLZER (imprägniert) 	2	70x45	3000
FH3	FUNDAMENTHÖLZER (imprägniert) 	3	70x45	2860
FH1	FUNDAMENTHÖLZER (imprägniert) 	2	70x45	2260
FH4	FUNDAMENTHÖLZER (imprägniert) 	1	70x45	850
PF1	PFETTEN 	2	44x145	3500
PF2	PFETTEN 	1	44x145	3500
	DACHBRETTER	62+1	113x18	1880
	FUSSBODENBRETTER	26+1	113x18	2325
	FUSSBODENLEISTEN	✓	18x40	12.0lfm

Nr.			Stck	Profil (mm)	Länge (mm)	
G02-1	GIEBELBRETTER 18x120	21.2° 	✓	4	18x120	1960
G06-1	GIEBELDECKLEISTEN 18x58		✓	4	18x58	1960
T06-1	TRAUFELEISTEN 18x40		✓		18x40	7.0lfm
T01-1	TRAUFENBRETTER 18x95			2	18x95	3500
SM-1	Sturmleisten			4	18x40	1940
GS	Giebelsegment			2		
SH	Schlaghölzer			3		
NG2 550	NÄGEL 2.5x50 Dachbretter			372		
NG2 550	NÄGEL 2.5x50 Fussbodenbretter			260		
SR3 030	SCHRAUBEN 3.0x30 Fussbodenleisten			22		
SR3 030	SCHRAUBEN 3.0x30 Traufenleisten			16		
SR3 545	SCHRAUBEN 3.5x45 Giebelbretter			16		
SR3 545	SCHRAUBEN 3.5x45 Giebeldeckleisten			16		
SR3 545	SCHRAUBEN 3.5x45 Giebelsegment			4		
SR3 545	SCHRAUBEN 3.5x45 Traufenbretter			16		
SR5 0100	SCHRAUBEN 5.0x100 Fundamenthölzer			32		
SS024	Schloßschrauben M8x70 Mutter M8 U-Scheibe Ø25 - Befestigung für Sturmleisten			12		
	✓ - bitte selber anpassen (falls nötig)!					

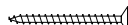
Nr.		Stck	Profil (mm)	Länge (mm)
	<p style="text-align: center;"><b>FENSTER 800x1204</b> <b>W4-S34P-06C-08001204</b></p> <div style="display: flex; justify-content: space-between;"> <div style="text-align: center;"> <p><b>Q4</b> W118-PC 800</p>  </div> <div style="border: 1px solid black; padding: 5px; width: 150px;"> <p>Right handed / DIN rechts / paremakäeline</p> </div> <div style="border: 1px solid black; padding: 5px; width: 150px;"> <p>Clear opening/ durchgangsmaß/ ava suurus</p> <p>644x1031mm</p>  </div> </div> <div style="border: 1px solid black; padding: 5px; width: 150px; margin-top: 5px;"> <p>double-pane clear float glass</p> <p>ISO Glas 2-fach</p> <p>2x klaaspakett, kirgas klaas</p> <p>585x979mm</p>  </div>	1		
VP54 32-1	<p>Q4 Window sill - Fensterbank - Veeplekk</p> 	1		642
PROSS H41-1	<p>Q4-1 Muntins - Sprossen - Prossid horizontal 18x18</p> 	2	18x18	610
PROSS V42-1	<p>Q4-2 Muntins - Sprossen - Prossid vertical 18x18</p> 	1	18x18	1014
PL3-1	<p>Trims - Rahmenleisten - Piirdeliistud 18x95</p> 	2	18x95	1000
PL3-2	<p>Trims - Rahmenleisten - Piirdeliistud 18x95</p> 	4	18x95	1285
PL3-3	<p>Trims - Rahmenleisten - Piirdeliistud 18x95</p> 	2	18x95	760
SR30 22-01	<p>3.0x20ÜP Muntins - Sprossen - Prossid</p> 	6		
SR35 45-01	<p>3.5x45 Trims - Rahmleisten - Piirdeliistud</p> 	24		
AL-Q4	<p>Q4 Window handle - Fenstergriff - Aknalink</p> 	1		
	<p>✓ - bitte selber anpassen (falls nötig)!</p>			

Nr.		Stck	Profil (mm)	Länge (mm)
	<p style="text-align: center;"><b>TÜR 840x1945</b> <b>D4-S34R-56C-08401945</b></p> <div style="display: flex; justify-content: space-between;"> <div style="text-align: center;"> <p><b>Q4 D101-RC</b> 840</p>  <p>1945</p> </div> <div style="border: 1px solid black; padding: 5px; width: 150px;"> <p>Right handed / DIN rechts / paremakäeline</p> </div> <div style="border: 1px solid black; padding: 5px; width: 150px;"> <p>Clear opening/ durchgangsmaß/ ava suurus</p> <p>712x1837mm</p>  </div> <div style="border: 1px solid black; padding: 5px; width: 150px;"> <p>double-pane clear float glass</p> <p>ISO Glas 2-fach</p> <p>2x klaaspakett, kirgas klaas</p> <p>549x950mm</p>  </div> </div>	1		
PROSS H41-2	Q4-1 Muntins - Sprossen - Prossid horizontal 18x18 	2	18x18	574
PRO SS V42-2	Q4-2 Muntins - Sprossen - Prossid vertical 18x18 	2	18x18	975
PL3-4	Trims - Rahmenleisten - Piirdeliistud 18x95  ✓	4	18x95	1925
PL3-5	Trims - Rahmenleisten - Piirdeliistud 18x95  ✓	2	18x95	1040
SR30 22-01	3.0x20ÜP Muntins - Sprossen - Prossid 	6		
SR35 45-01	3.5x45 Trims - Rahmleisten - Piirdeliistud 	22		
LS-Q4	Q4 Cylinder lock - Zylinderschloss - Lukusüdamik 	1		
UL-Q4	Q4 Door handle - Türgriff - Ukselink 	1		
	✓ - bitte selber anpassen (falls nötig)!			



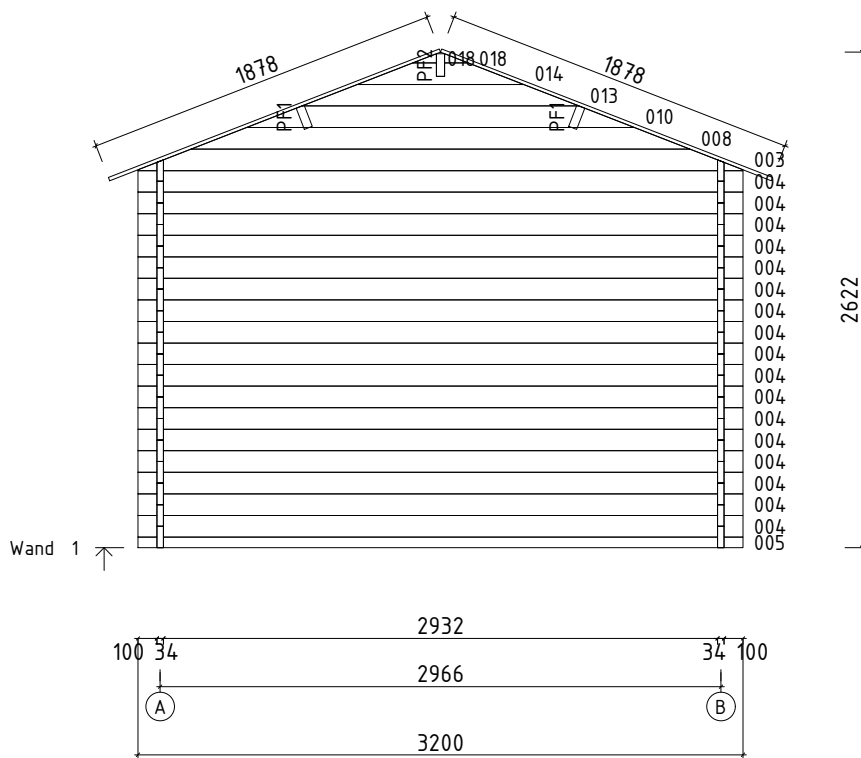

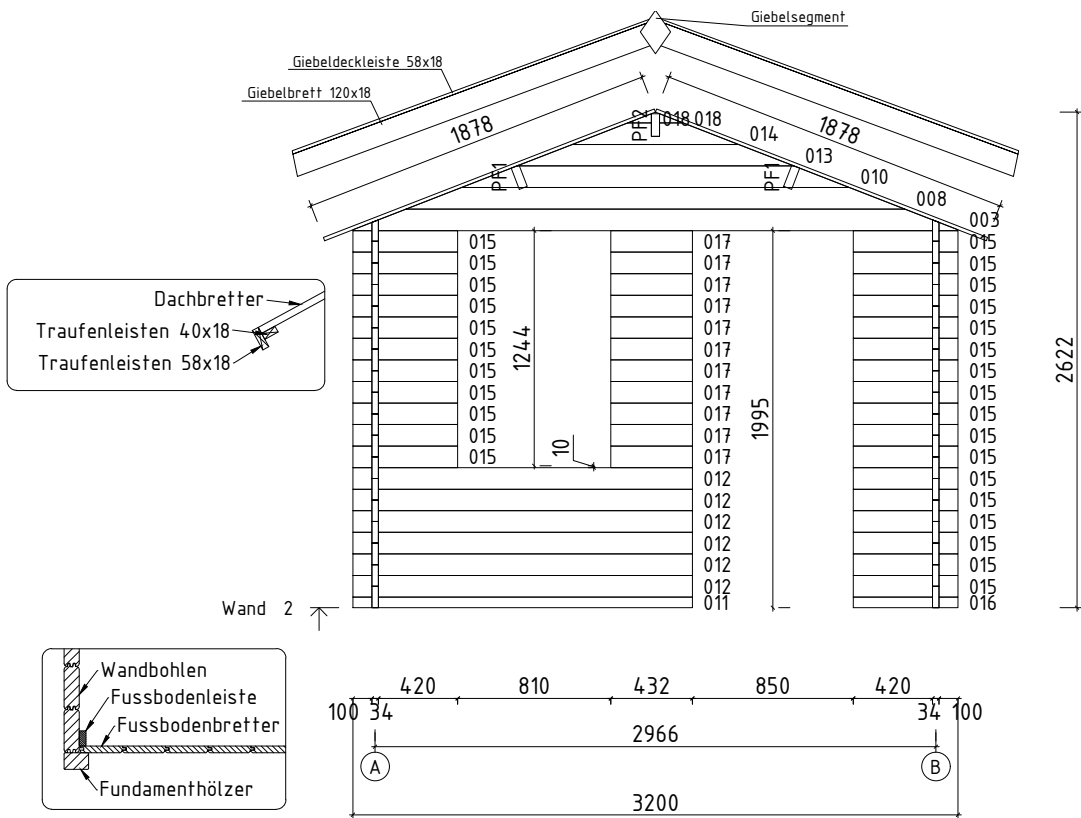





Aken Q4-Q6 - paigaldusjuhised  
 Window Q4-Q6 - assembly instructions  
 Fenster Q4-Q6 - Montageanleitung

