

**Technische Daten: Art.-Nr.: 231 710**

**Bohlenstärke: 28 mm**



Kontrolliert durch:

Achtung: Alle angegebenen Maße sind ca.-Maße!

# 3D-Darstellung Art.-Nr. 231 710

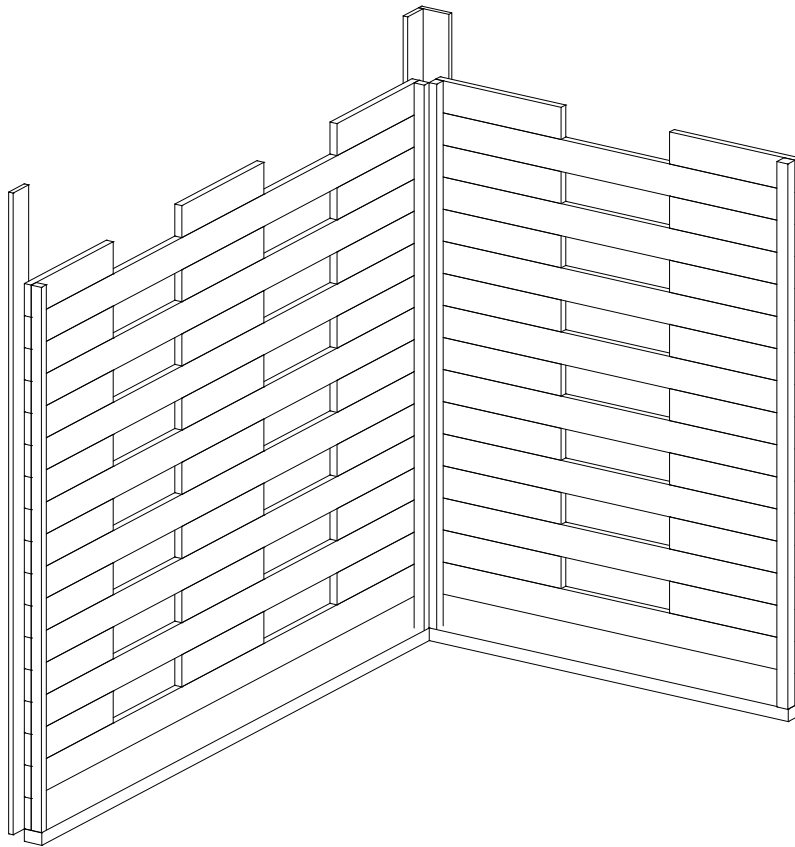





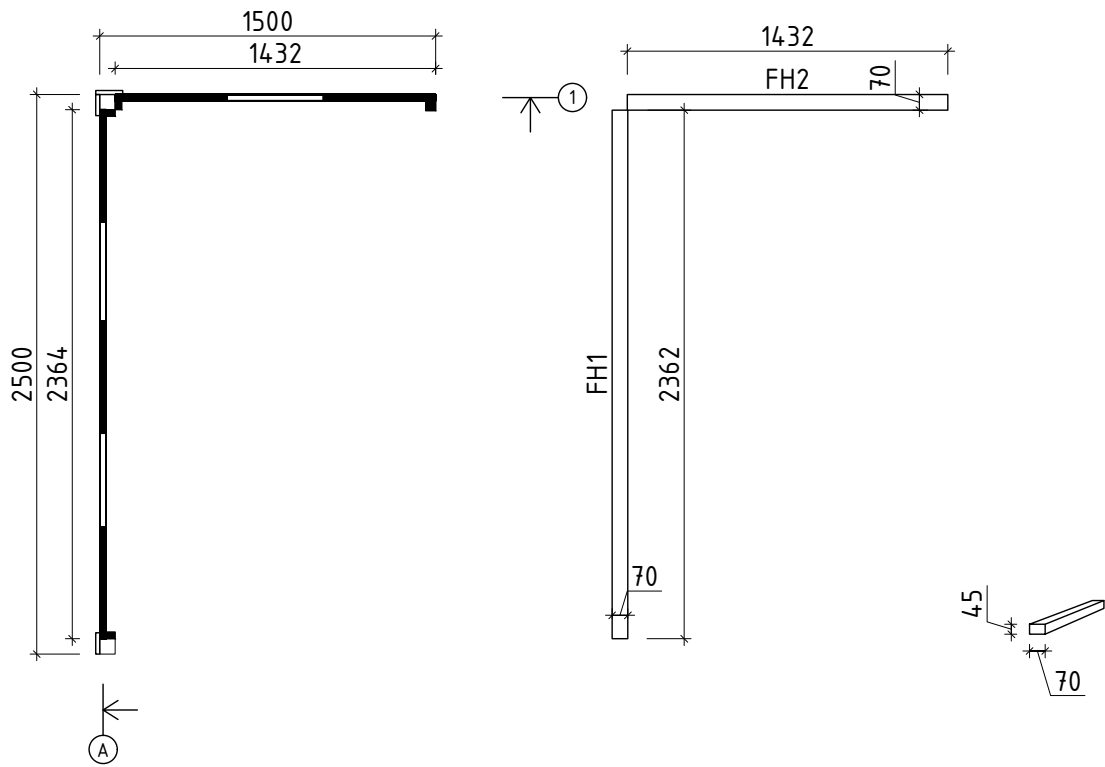



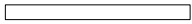

# Grundriss

## Art.-Nr. 231 710

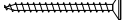
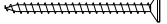
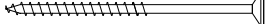
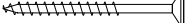

# Teileliste 1

## Art.-Nr. 231 710

Pos		Stck	Profil (mm)	Länge (mm)
001		9	28x114	2364
002		9	28x114	1432
003		40	28x114	500
FH1	FUNDAMENTHÖLZER (imprägniert) 	1	70x45	2362
FH2	FUNDAMENTHÖLZER (imprägniert) 	1	70x45	1432
LE2	LEISTE 	✓ 1	120x18	2166
LE1	LEISTE 	✓ 1	95x18	2280
LE3	LEISTE 	✓ 1	95x18	2166
EP2	ECKPFOSTEN 	1	44x44	1938
EP1	ECKPFOSTEN 	2	30x40	1938
SR37	SCHRAUBEN 3.5x45 LE1, LE2, LE3 	30		
SR44	SCHRAUBEN 4.0x60 Wandbohlen zu Eckpfosten EP1, EP2 Eckpfosten zu Stützpfeosten EP1 	118		
SR57	SCHRAUBEN 5.0x100 Fundamenthölzer 	8		
SR55	SCHRAUBEN 5.0x70 Eckpfoste EP2 zu Haus 	6		
SH	Schlaghölzer 	3		
	✓ - bitte selber anpassen (falls nötig!)			

# Wandplan 1

## Art.-Nr. 231 710

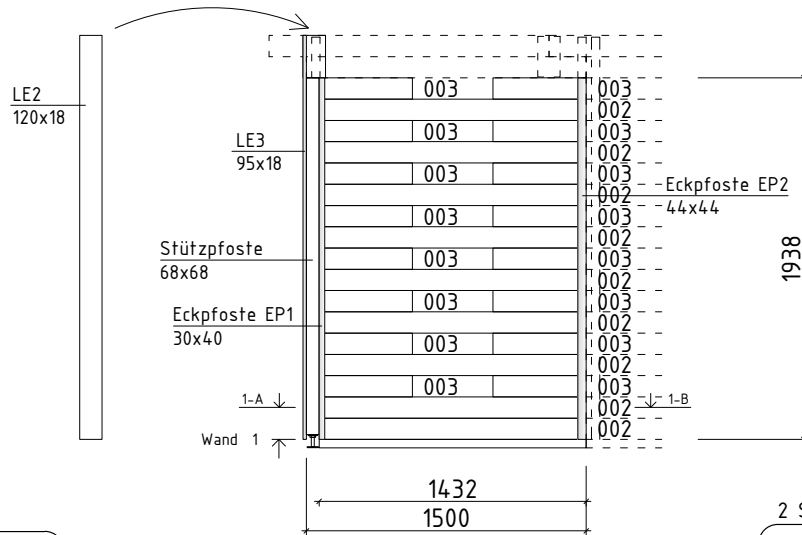

1-A

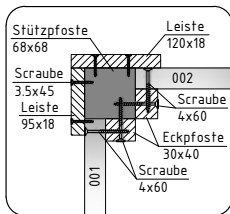

1-B

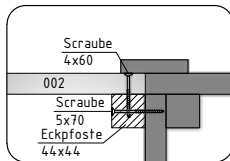

2 Schrauben für Bohle

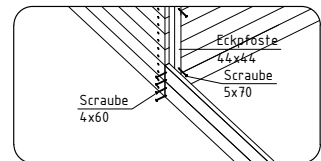

# Wandplan A Art.-Nr. 231 710

