

**Technische Daten: Art.-Nr.: 231 620**

**Wandaußenmaß: 250 x 250 cm**

**Bohlenstärke: 28 mm**



**Kontrolliert durch:**

Achtung: Alle angegebenen Maße sind ca.-Maße!

# 3D-Darstellung Art.-Nr. 231 620

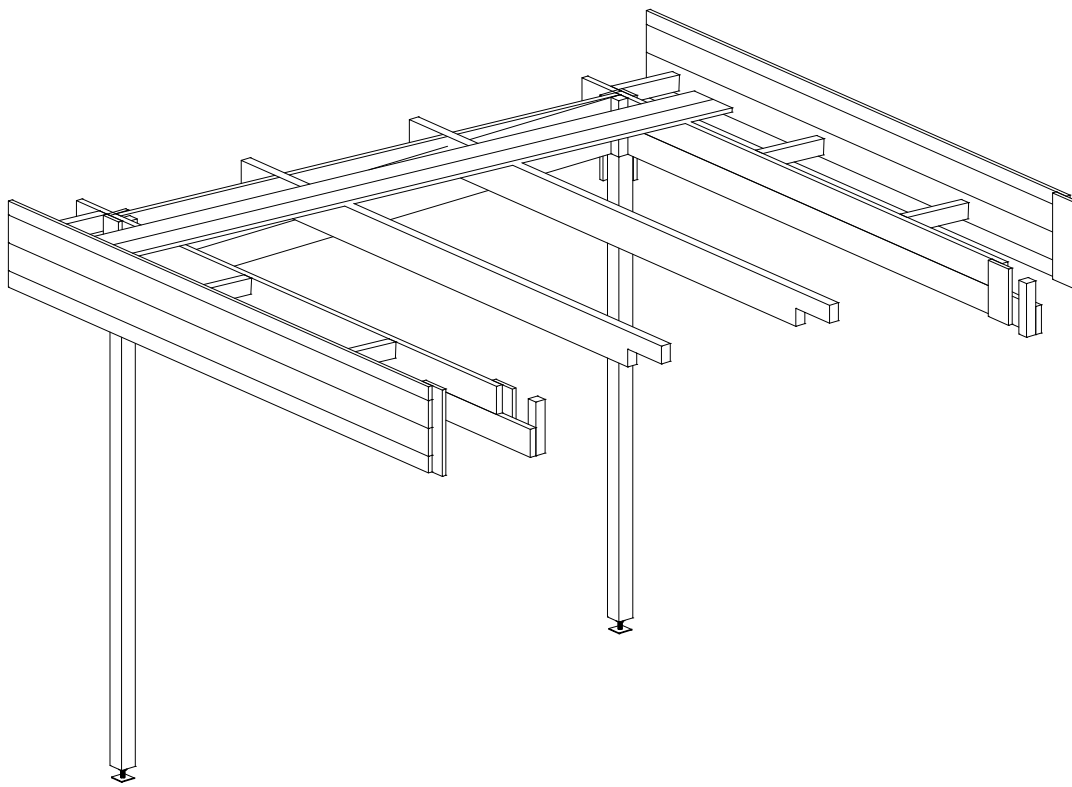





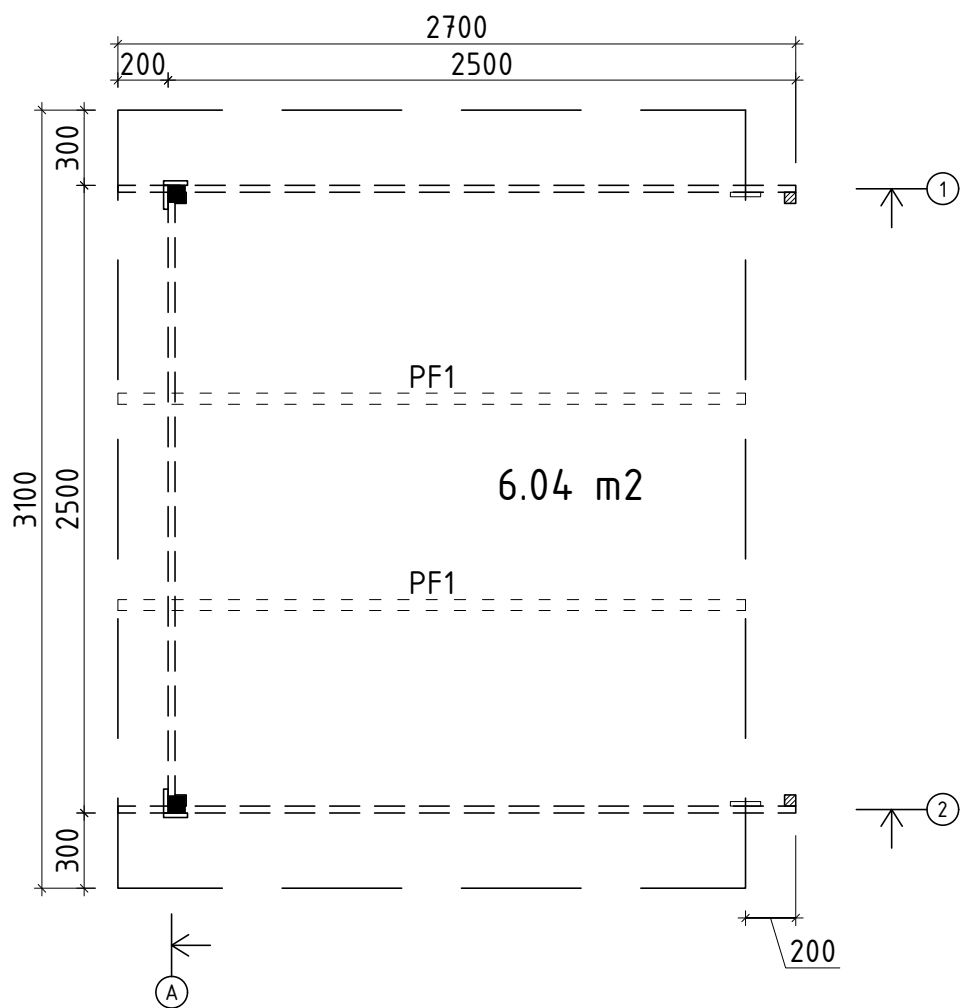





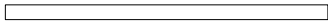
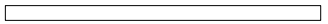
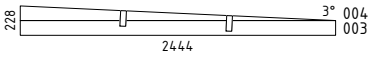

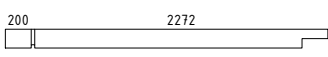
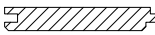
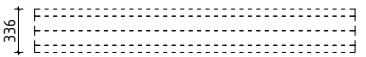
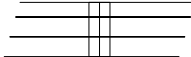

# Grundriss

## Art.-Nr. 231 620

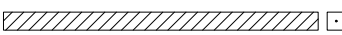
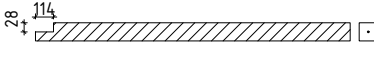

# Teileliste 1

## Art.-Nr. 231 620

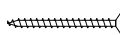
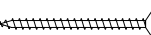
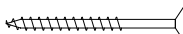
Pos		Stck	Profil (mm)	Länge (mm)
001		2	28x114	2500
002		2	28x114	2500
003		1	28x114	2444
WA-1		1		
LE2	 LEISTE	2	120x18	218
LE1	 LEISTE	4	95x18	342
EP1	 ECKPFOSTEN	4	44x44	218
PF1	 PFETTEN	2	44x145	2500
	DACHBRETTER 	23+1	113x18	3005
BL-1	DACHBLENDEN 336mm 	2	18x336	2500
VL-1	DACHBLENDEN- Verbindungsleisten 	2	18x120	336
BS-1	DACHBLENDEN- Blendenstützen 44x65 	6	44x65	300
UPB-1	DACHBLENDEN- U-Profil für Blenden  ✓	2	65x44	2600
DPL-1	DACHPAPPENLEISTEN 15x28 	1	15x28	2500
T06-1	TRAUFENLEISTEN 18x40 	2	18x40	2500
TP68-1	STÜTZPFOSTEN 68x68  ✓	1	68x68	2000
TP68-2	STÜTZPFOSTEN 68x68  ✓	1	68x68	2110
SH	Schlaghölzer 	3		
KP-1	DACHPAPPE  ✓	3,2m-4st.		13,0 lfdm
NG01	DACHPAPPNÄGEL 2.8x15 	175		
NG04	NÄGEL 2.5x50 Dachbretter 	184		
SR32	SCHRAUBEN 3.0x30 Dachpappenleisten Traufenleisten, Verbindungsleisten 	31		
SR37	SCHRAUBEN 3.5x45 U-Profil LE1, LE2 	66		
SR44	SCHRAUBEN 4.0x60 Wandbohlen zu Eckpfosten 	28		
SR55	SCHRAUBEN 5.0x70 Blendenbefestigung Blendestützen, EP1 	36		

# Teileliste 2

## Artikel-Nr.: 231 620

Pos		Stck.	Profil (mm)	Länge (mm)
SR62	SCHRAUBEN 6.0x140 (ASSY für Pfetten) 	4		
VP1	Verstellbare Pfostenstütze M10 	2		
	✓ - bitte selber anpassen (falls nötig!)			

# Wandplan 1 und 2

## Art.-Nr. 231 620

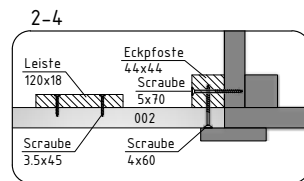
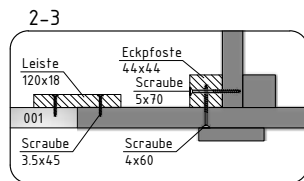
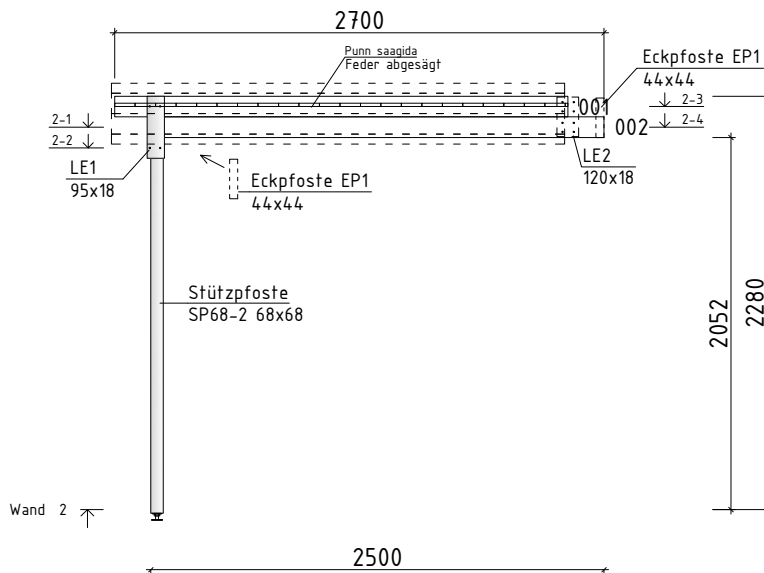
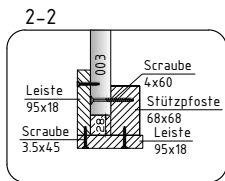
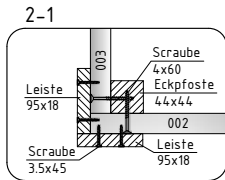
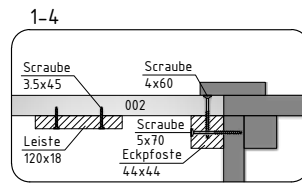
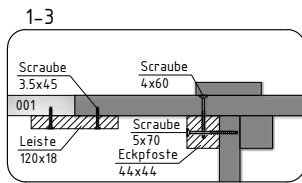
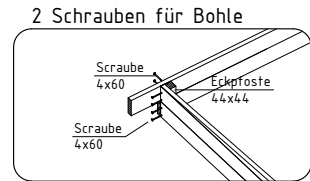
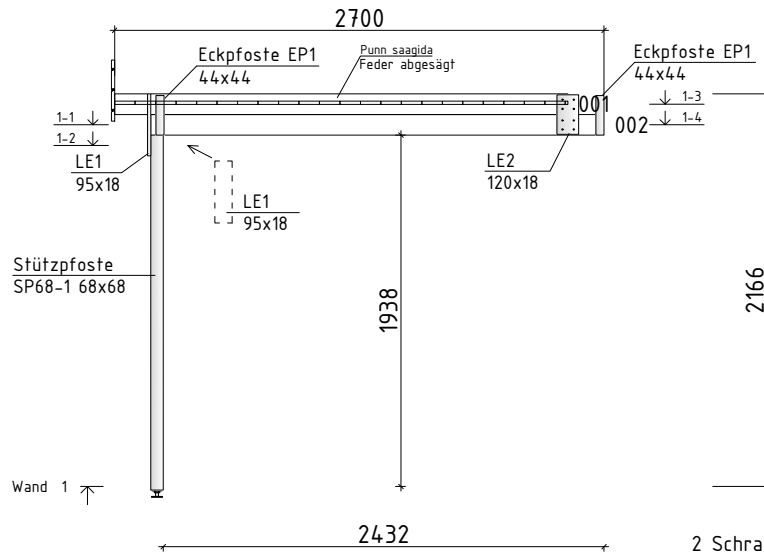
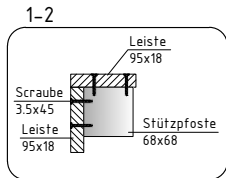
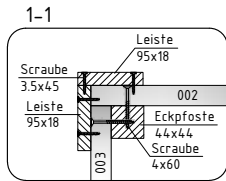

# Wandplan A

## Art.-Nr. 231 620

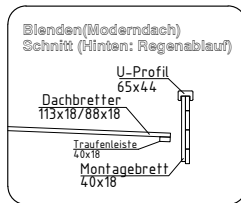
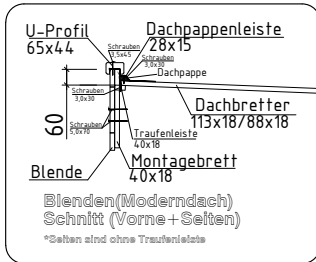
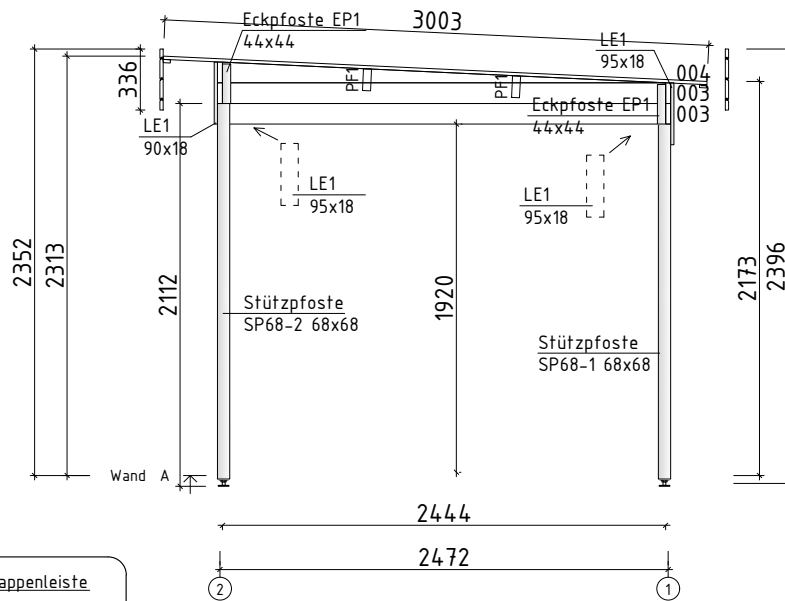

# Detailzeichnung

## Art.-Nr. 231 620

### Pärlinite ühendamine / Verbinden der Pfetten / Connecting purlins

