

Technische Daten



Spiegelverkehrte Montage möglich.

Artikelnummer:

231 550

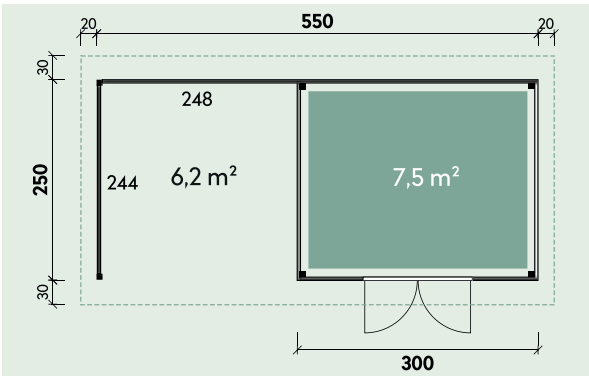



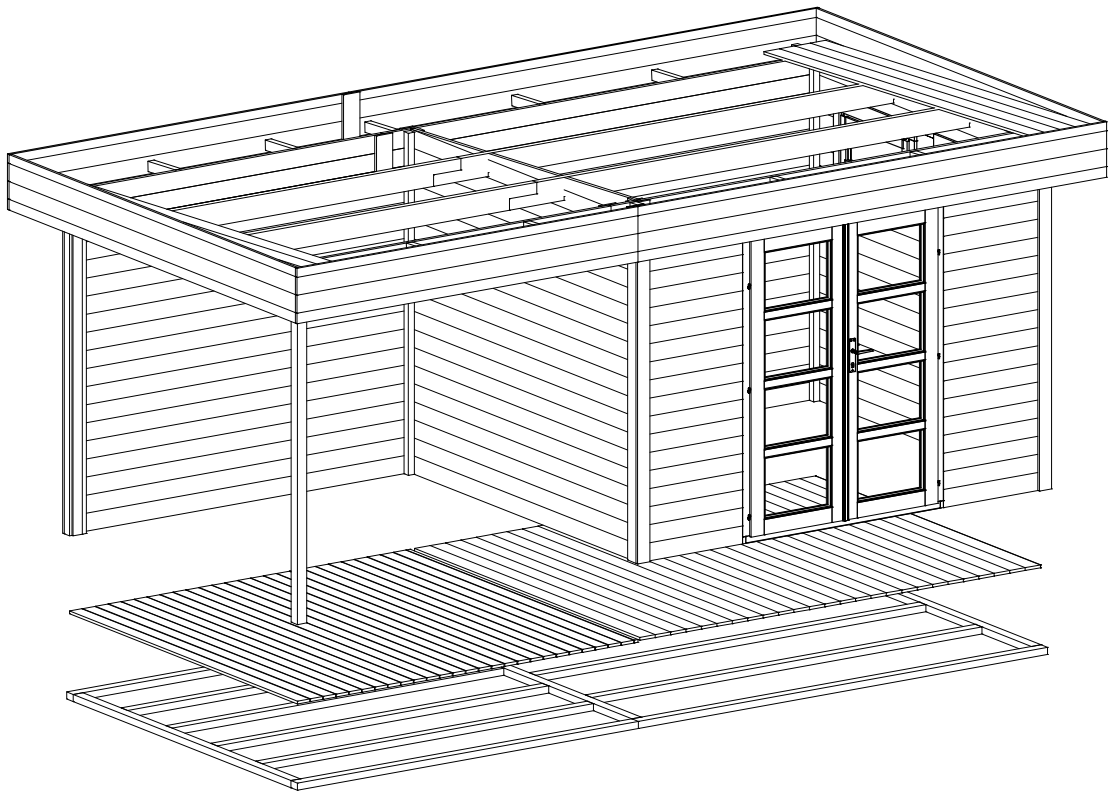

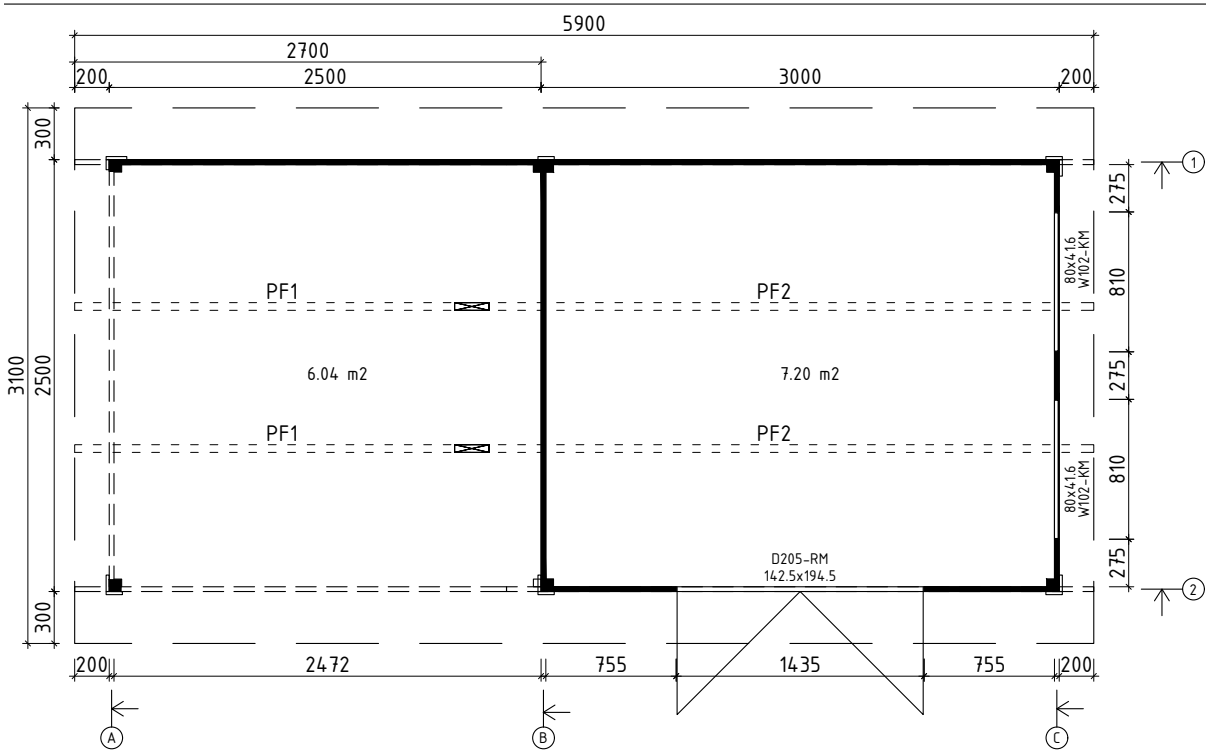



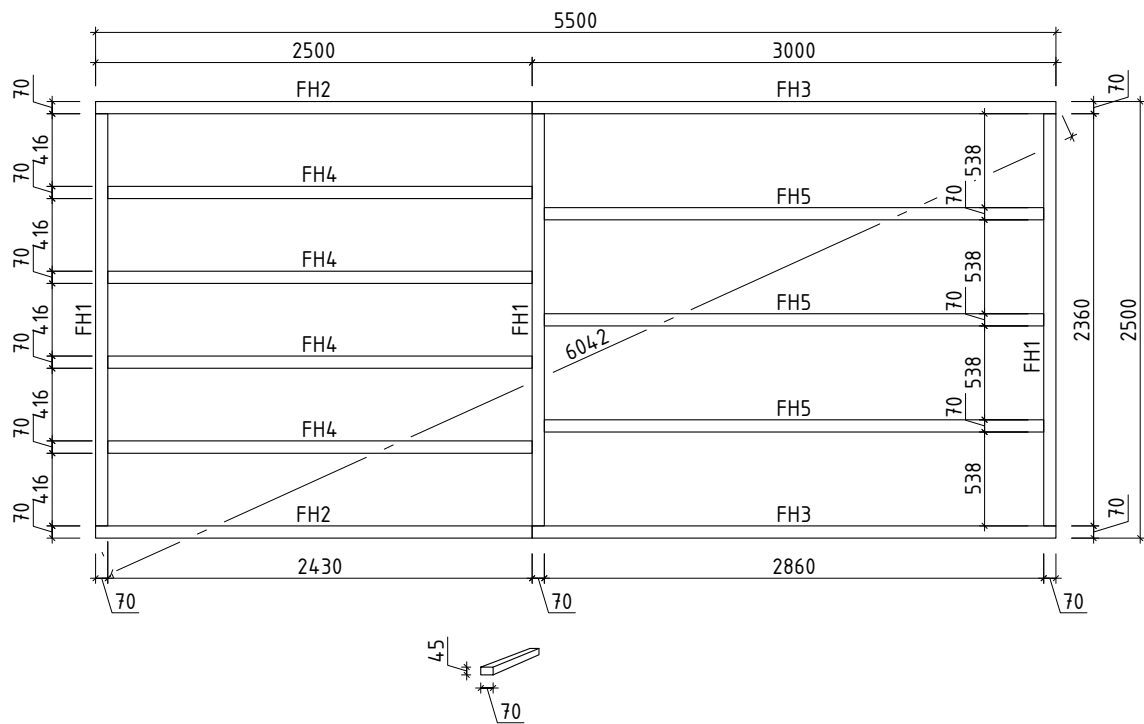





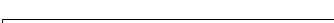





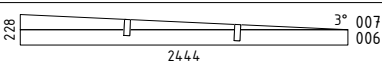
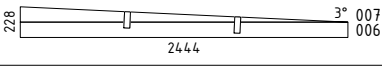
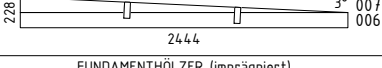

Kontrolliert durch:











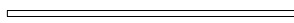



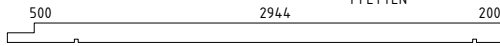
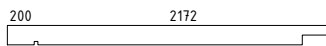
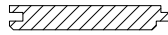

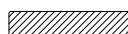

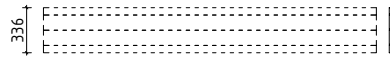
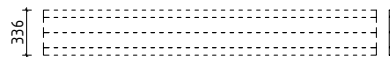
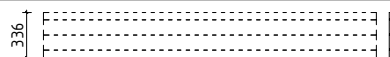
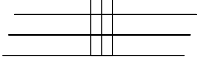

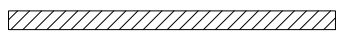
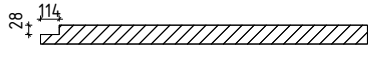

Wir empfehlen als Fundament für Ihr Gartenhaus eine vollflächig festgegründete, gepflasterte oder betonierte Fläche. Wahlweise ist auch ein Punkt- oder Streifenfundament möglich.



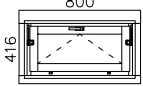
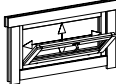

| Nr. | | Stck | Profil (mm) | Länge (mm) |
|------|--|------|-------------|------------|
| 001 |  | 2 | 28x114 | 3400 |
| 002 |  | 19 | 28x114 | 3000 |
| 003 |  | 1 | 28x114 | 3000 |
| 004 |  | 2 | 28x114 | 2500 |
| 005 |  | 2 | 28x114 | 2500 |
| 006 |  | 33 | 28x114 | 2444 |
| 008 |  | 17 | 28x114 | 2432 |
| 009 |  | 34 | 28x114 | 768 |
| 010 |  | 8 | 28x114 | 275 |
| 011 |  | 4 | 28x114 | 275 |
| WA-1 |  | 1 | | |
| WB-1 |  | 1 | | |
| WC-1 |  | 1 | | |
| FH3 | FUNDAMENTHÖLZER (imprägniert)  | 2 | 70x45 | 3000 |
| FH5 | FUNDAMENTHÖLZER (imprägniert)  | 3 | 70x45 | 2860 |
| FH2 | FUNDAMENTHÖLZER (imprägniert)  | 2 | 70x45 | 2500 |
| FH4 | FUNDAMENTHÖLZER (imprägniert)  | 4 | 70x45 | 2430 |
| FH1 | FUNDAMENTHÖLZER (imprägniert)  | 3 | 70x45 | 2360 |
| LE2 | LEISTE  | 1 | 120x18 | 2166 |
| LE3 | LEISTE  | 2 | 120x18 | 228 |
| LE6 | LEISTE  | ✓ 4 | 95x18 | 2280 |
| LE4 | LEISTE  | ✓ 3 | 95x18 | 2166 |
| LE5 | LEISTE  | 2 | 95x18 | 342 |
| LE1 | LEISTE  | ✓ 1 | 58x18 | 2166 |
| LE7 | LEISTE  | 2 | 15x28 | 1938 |
| | | | | |

| Nr. | | Stck | Profil (mm) | Länge (mm) |
|--------|---|------|-------------|------------|
| EP5 |  ECKPFOSTEN | 2 | 44x44 | 2270 |
| EP3 |  ECKPFOSTEN | 3 | 44x44 | 2156 |
| EP4 |  ECKPFOSTEN | 1 | 44x44 | 332 |
| EP1 |  ECKPFOSTEN | 2 | 44x44 | 218 |
| EP2 |  ECKPFOSTEN | 1 | 30x40 | 1938 |
| PF2 |  PFETTEN 500 2944 200 | 2 | 44x145 | 3700 |
| PF1 |  PFETTEN 200 2172 | 2 | 44x145 | 2400 |
| | DACHBRETTEN  | 54+1 | 113x18 | 3005 |
| | FUSSBODENBRETTEN  | 27+1 | 113x18 | 2440 |
| | TERRASSENBRETTEN (imprägniert)  | 27+1 | 90x18 | 2470 |
| | FUSSBODENLEISTEN  ✓ | | 18x40 | 11,0 lfdm |
| BL-1 | DACHBLENDEN 336mm  336 | 2 | 18x336 | 2500 |
| BL-2 | DACHBLENDEN 336mm  336 | 2 | 18x336 | 3100 |
| BL-3 | DACHBLENDEN 336mm  336 | 2 | 18x336 | 3436 |
| VL-1 | DACHBLENDEN- Verbindungsleisten  | 2 | 18x120 | 336 |
| BS-1 | DACHBLENDEN- Blendenstützen 44x65  | 14 | 44x65 | 300 |
| UPB-1 | DACHBLENDEN- U-Profil für Blenden  40 ✓ | | 65x44 | 19,0 lfdm |
| DPL-1 | DACHPAPPENLEISTEN 15x28  ✓ | | 15x28 | 12,0 lfdm |
| T06-1 | TRAUFENLEISTEN 18x40  ✓ | | 18x40 | 12,0 lfdm |
| TP68-1 | STÜTZPFOSTEN 68x68  ✓ | 1 | 68x68 | 1938 |
| TP68-2 | STÜTZPFOSTEN 68x68  28 114 ✓ | 1 | 68x68 | 2052 |
| SH | Schlaghölzer  | 3 | | |
| KP-1 | DACHPAPPE  ✓ | | 6,6m-4st. | 27,0 lfdm |
| NG01 | DACHPAPPNÄGEL 2.8x15  | 410 | | |
| NG04 | NÄGEL 2.5x50  Dachbretter Fußbodenbretter, Terrassenbretter | 1026 | | |

| Nr. | | | Stck | Profil (mm) | Länge (mm) |
|------|--|--|--|-------------|------------|
| SR32 | SCHRAUBEN 3.0x30 | Dachpappenleisten, Verbindungsleisten Fussbodenteisten, Traufenleisten |  | 88 | |
| SR37 | SCHRAUBEN 3.5x45 | U-Profil LE1-LE7 |  | 198 | |
| SR44 | SCHRAUBEN 4.0x60 | Wandbohlen zu Eckpfosten |  | 416 | |
| SR57 | SCHRAUBEN 5.0x100 | Fundamenthölzer |  | 56 | |
| SR55 | SCHRAUBEN 5.0x70 | Blendenbefestigung Blendestützen, EP1, EP3 |  | 92 | |
| SR62 | SCHRAUBEN 6.0x140 (ASSY für Pfetten) |  | 4 | | |
| | | | | | |
| | | | | | |
| | | | | | |
| | | | | | |
| | | | | | |
| | | | | | |
| | | | | | |
| | | | | | |
| | | | | | |
| | | | | | |
| | | | | | |
| | | | | | |
| | | | | | |
| | | | | | |
| | | | | | |
| | | | | | |
| | | | | | |
| | | | | | |
| | | | | | |
| | | | | | |
| | ✓ - bitte selber anpassen (falls nötig)! | | | | |

| Nr. | | Stck | Profil (mm) | Länge (mm) |
|--------------|---|------|-------------|------------|
| | <p style="text-align: center;">FENSTER 800x416 W2-S28K-0XM-08000416</p> <div style="display: flex; justify-content: space-between; align-items: flex-start;"> <div style="text-align: center;"> <p>Q2 W102-KM</p>  </div> <div style="border: 1px solid black; border-radius: 10px; padding: 5px; width: 150px;"> <p>Tilt window / Kippfenster/ klappaken</p> </div> <div style="border: 1px solid black; border-radius: 10px; padding: 5px; width: 150px;"> <p>Clear opening/ durchgangsmaß/ ava suurus </p> <p>686x302mm</p> </div> <div style="border: 1px solid black; border-radius: 10px; padding: 5px; width: 150px;"> <p>matt glass  Floatglas Satinirt matt klaas 629x235mm</p> </div> </div> | 2 | | |
| AL-Q 2-Q3 | Q2-Q3 Window handle - Fenstergriff - Aknalink  | 2 | | |
| | | | | |
| | | | | |
| | | | | |
| | | | | |
| | | | | |
| | | | | |
| | | | | |
| | | | | |
| | | | | |
| | | | | |
| | | | | |
| | | | | |
| | | | | |
| | | | | |
| | | | | |
| | | | | |
| | | | | |
| | | | | |
| | | | | |
| | | | | |

| Nr. | | Stck | Profil (mm) | Länge (mm) |
|---------------|---|------|-------------|------------|
| | <p style="text-align: center;">TÜR 1425x1945 D2-D28R-LLM-14251945</p> <p>Q2 D205-RM 1425</p>  <div style="display: flex; justify-content: space-between; align-items: flex-start;"> <div data-bbox="659 398 956 454" style="border: 1px solid black; border-radius: 10px; padding: 2px;"> Right handed / DIN rechts / paremakäeline </div> <div data-bbox="659 461 956 573" style="border: 1px solid black; border-radius: 10px; padding: 2px;"> Clear opening/ durchgangsmaß/ ava suurus 1337x1857mm  </div> <div data-bbox="659 584 956 730" style="border: 1px solid black; border-radius: 10px; padding: 2px;"> matt glass Floatglas Satinirt matt klaas 492x382mm  </div> </div> | 1 | | |
| SR25 15-01 | 2.5x15 Locking plate - Schließblech - Riivi vastus 01 Q2-Q3 | 2 | | |
| SR50 90-01 | 5.0x90 Door frames - Türrahmen - Ukselengid | 8 | | |
| RV01 | Locking plate - Schließblech - Riivi vastus 01 Q2-Q3 | 1 | | |
| UL-Q 2-Q3 | Q2-Q3 Door handle - Türgriff - Ukselink | 1 | | |
| LS-Q4 | Q4 Cylinder lock - Zylinderschloss - Lukusüdamik | 1 | | |
| | | | | |
| | | | | |
| | | | | |
| | | | | |
| | | | | |
| | | | | |
| | | | | |
| | | | | |
| | | | | |
| | | | | |
| | | | | |
| | | | | |
| | | | | |
| | | | | |
| | | | | |
| | | | | |
| | | | | |

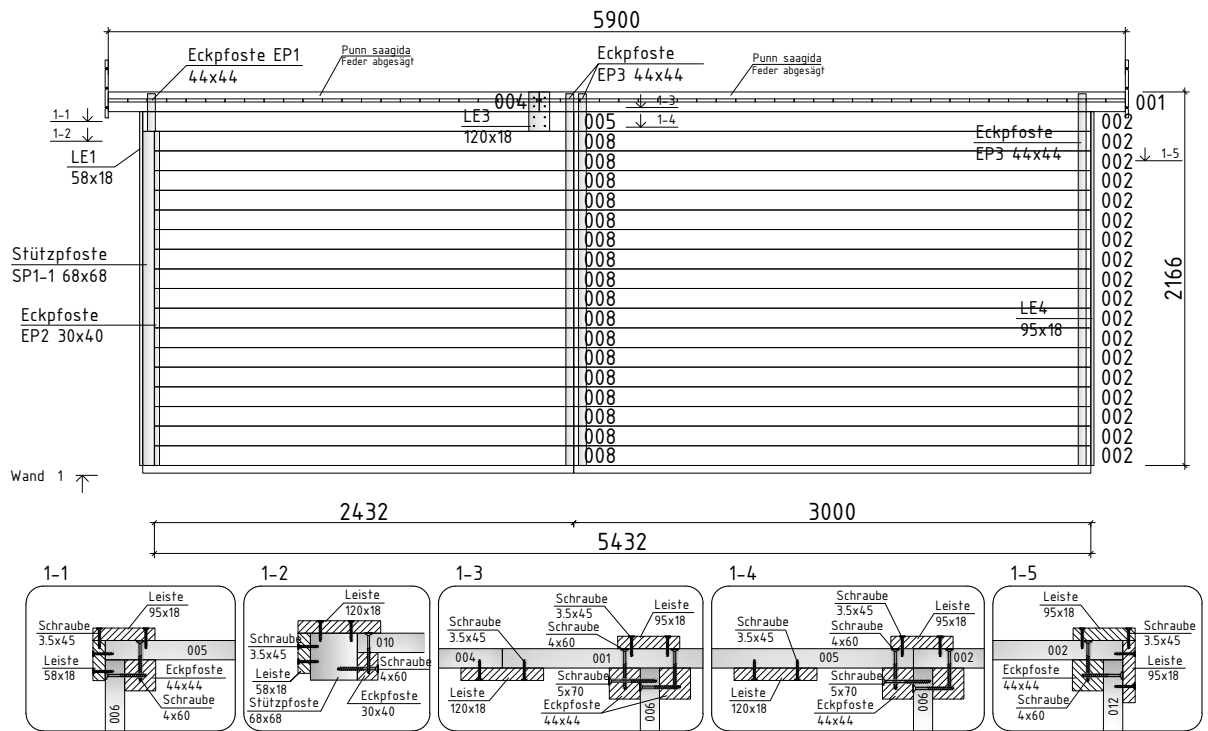

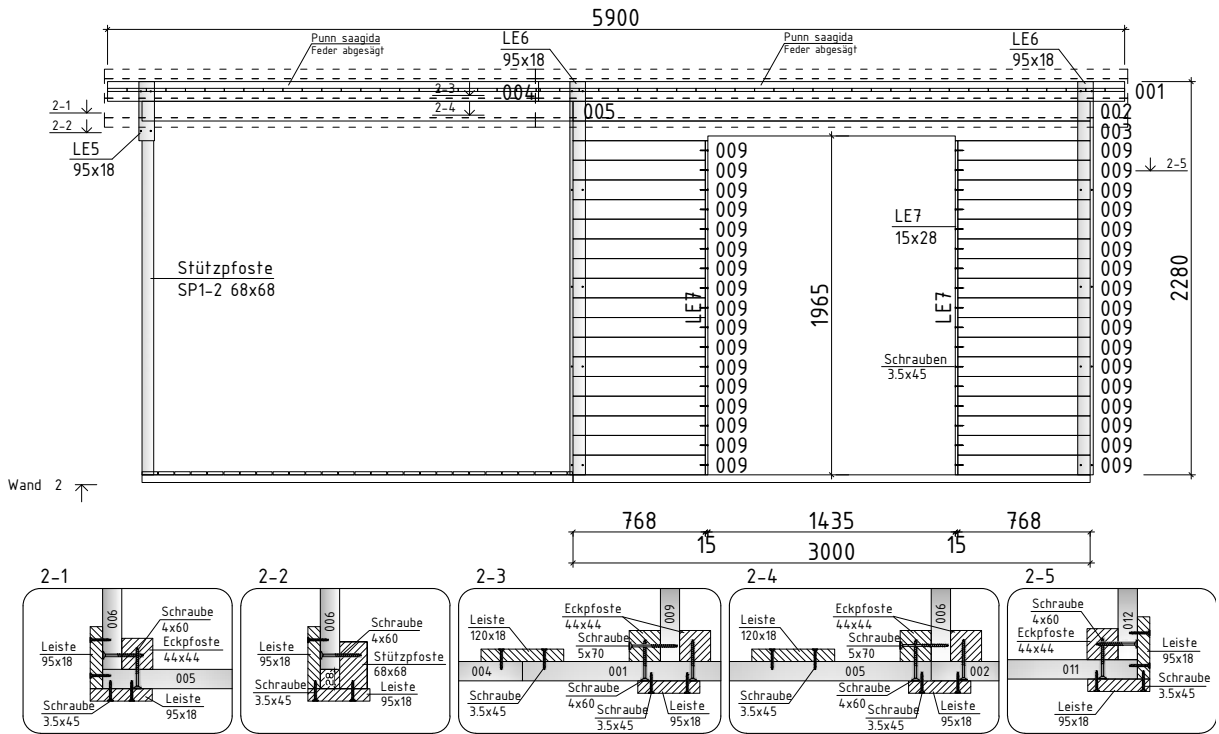

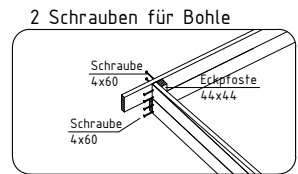
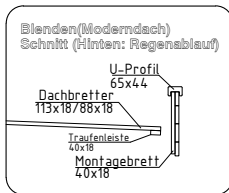
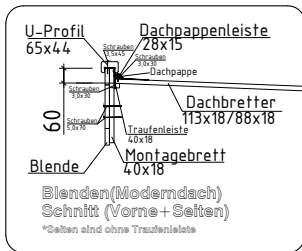
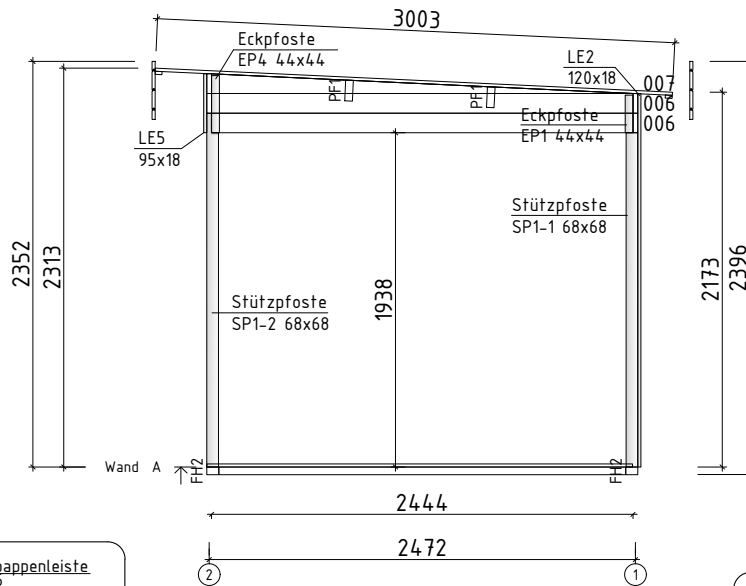

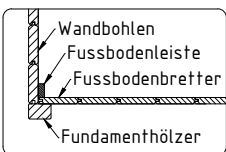
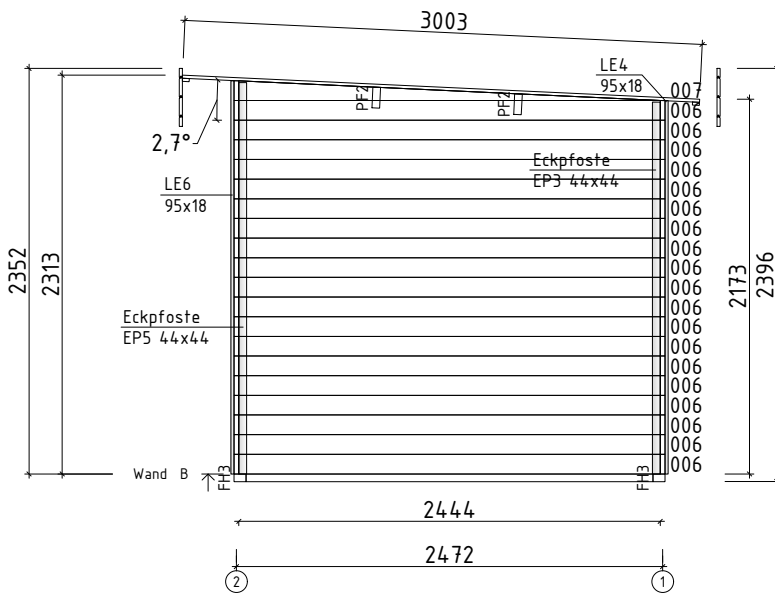

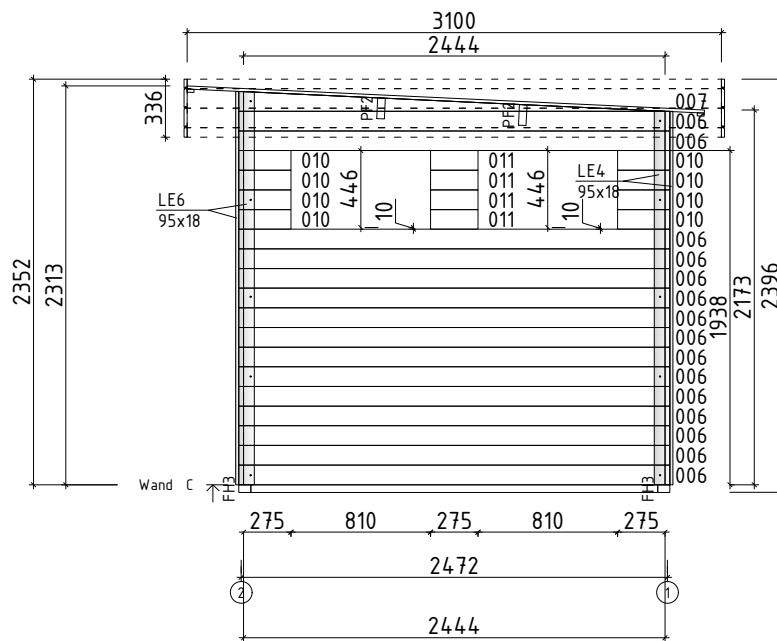

Pärlinite ühendamine / Verbinden der Pfetten / Connecting purlins

| | | |
|---|--|---|
| | <p>1</p> <p>Pärlin/Pfette/Purlin</p> <p>Kruvi/Schraube/ Screw 6x140</p> | <p>2</p> <p>Keerake kruvid poole ulatuses sisse . (Vaja läheb Assy AW30 või Torx T30 otsikut) ☆ Drehen Sie die Schrauben bis zur Hälfte seiner Länge ein. (Für diese Schrauben benötigen Sie einen Assy AW30 oder Innentorx T30 Schraubereinsatz) ☆ Turn the screws up until the first half. (These screws require Assy AW30 or Torx T30 driver bit) ☆</p> |
| <p>Märkige kruvide asukohad / Markieren Sie die empfehlenden Schraubenpositionen / Mark the suggested positions for screws</p> | | |
| <p>3</p> <p>Hoia ühendatavad pärlinid tihedalt koos / Setzen Sie die Enden der Balken zusammen / Keep purlins tight together</p> | <p>4</p> <p>Keera kruvid lõpuni sisse / Drehen Sie die Schrauben dann ganz ein / Turn the screws up until the end</p> | |
| | | |

