

# Technische Daten

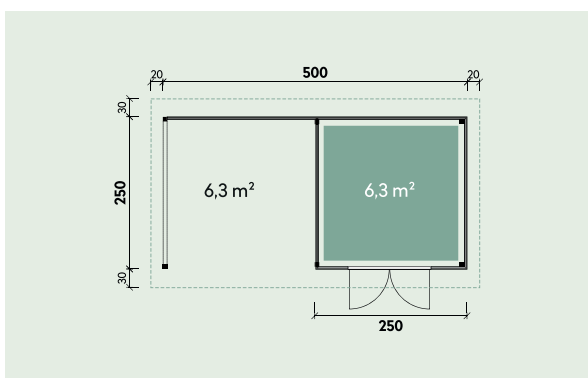

## Artikelnummer:

231 540



Kontrolliert durch:

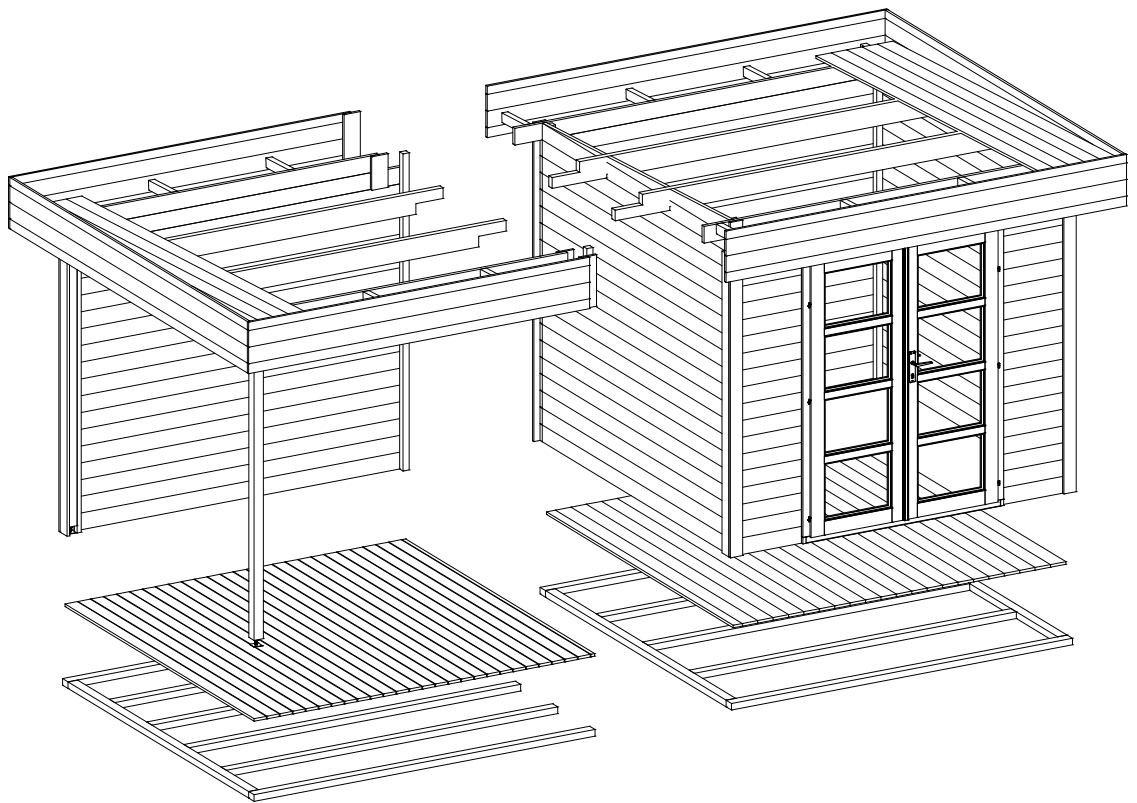
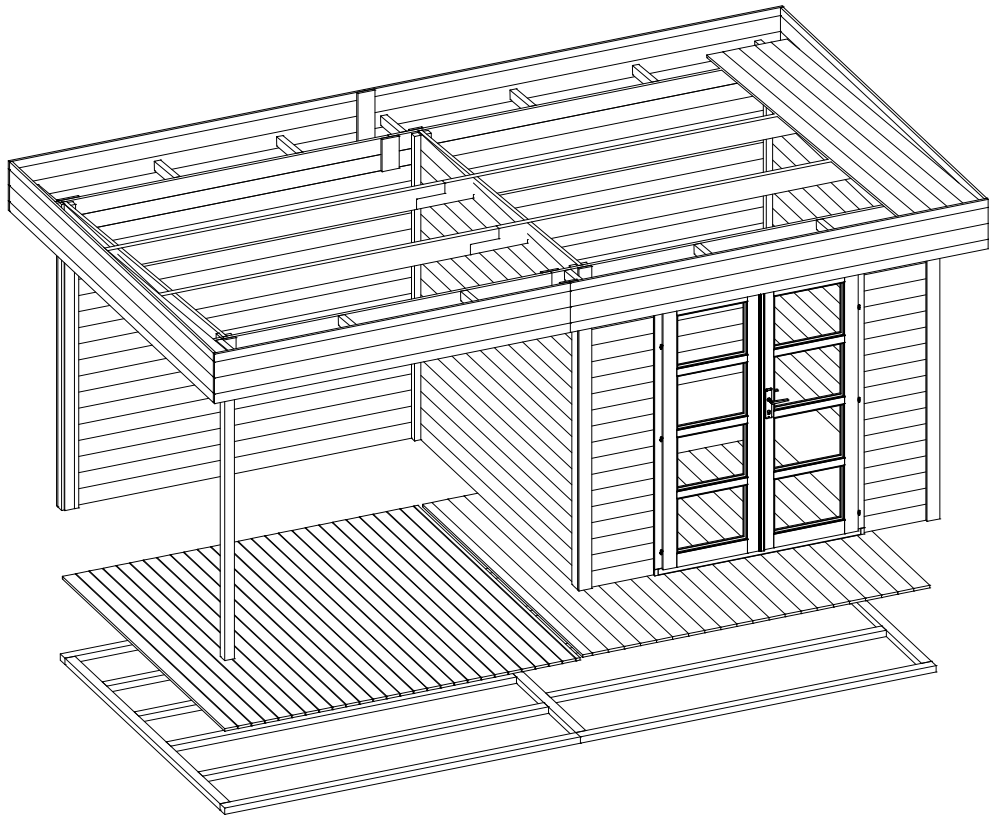

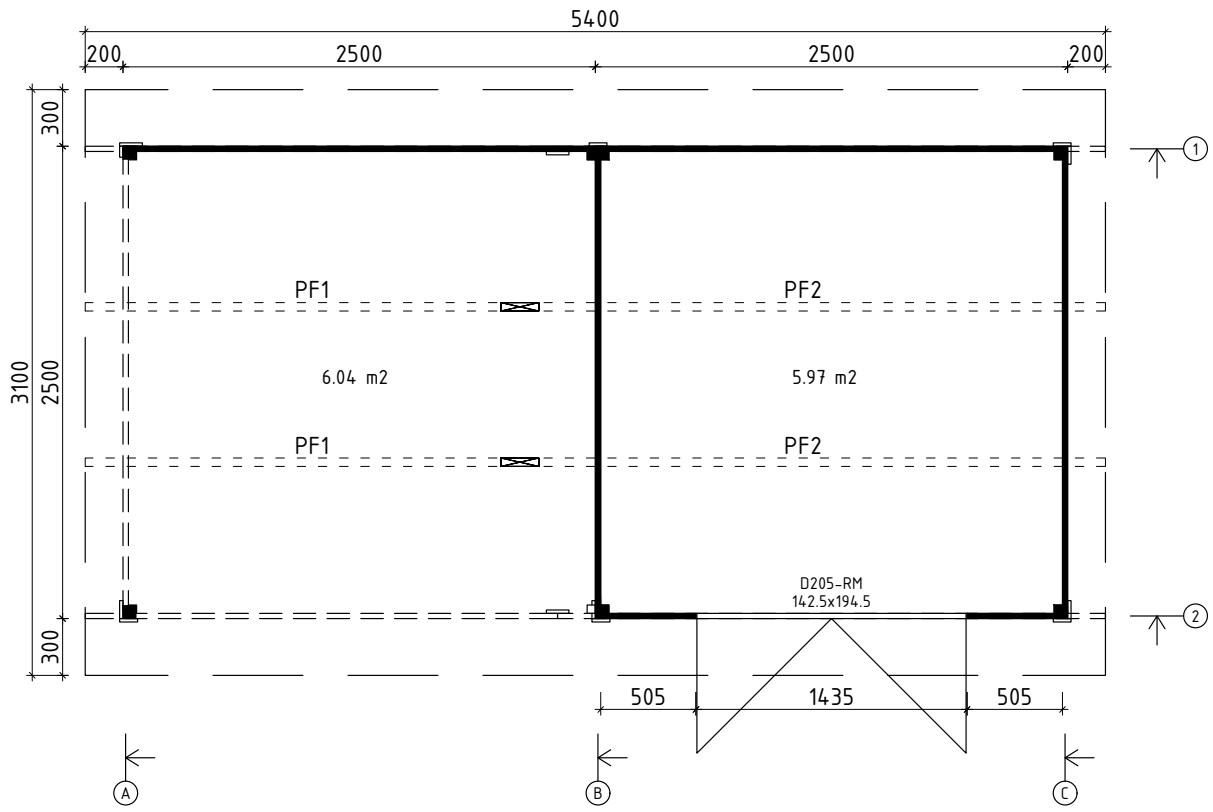





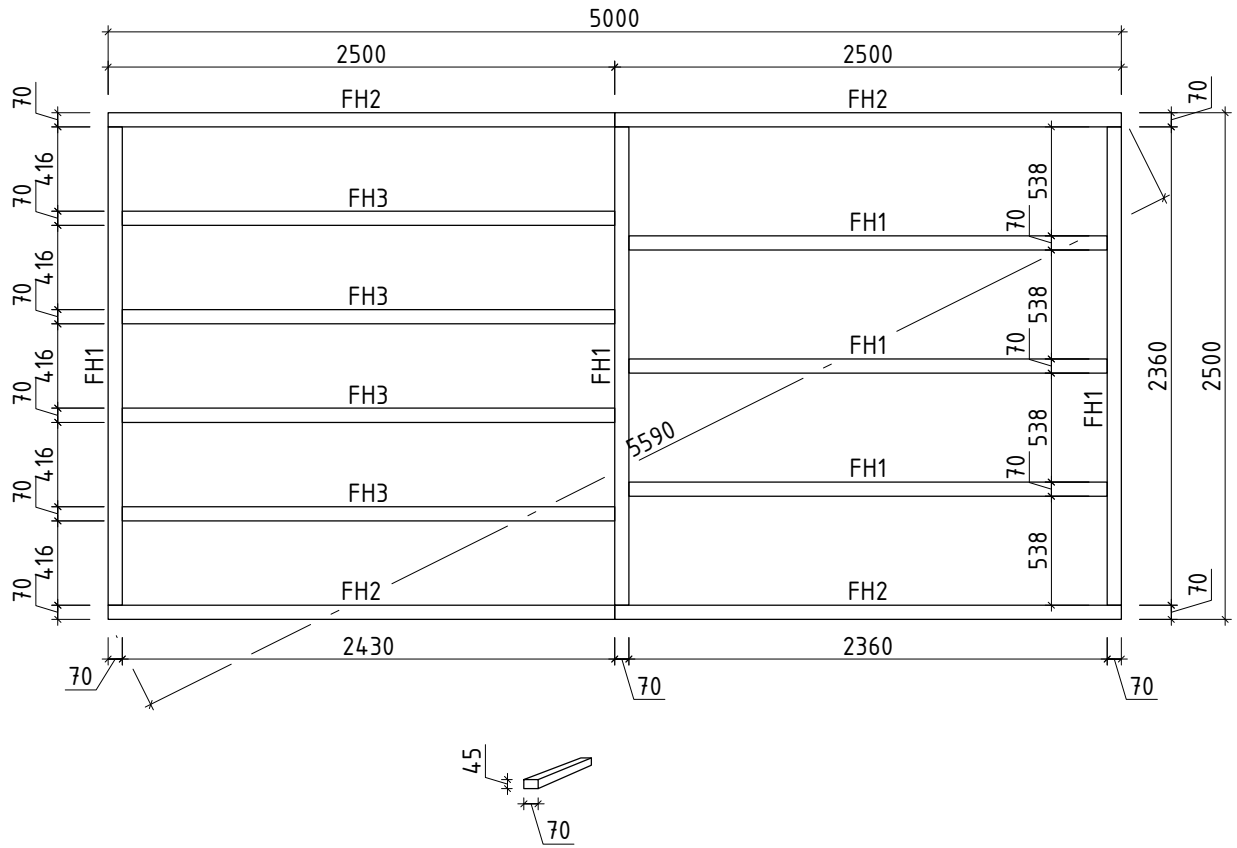



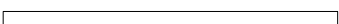



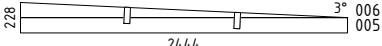
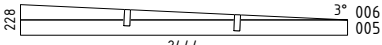
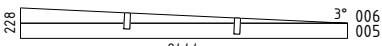
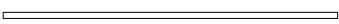









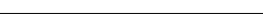
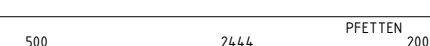

Q2 – Qualitätsklasse für Fenster und Türen

**Wir empfehlen als Fundament für Ihr Gartenhaus eine vollflächig festgegründete, gepflasterte oder betonierte Fläche. Wahlweise ist auch ein Punkt- oder Streifenfundament möglich.**

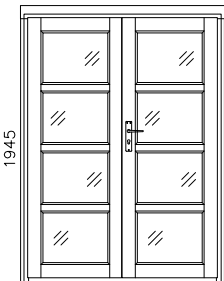
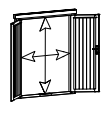

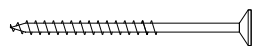
Pos	Teilleiste	Stck	Profil (mm)	Länge (mm)
001		2	28x114	2900
002		2	28x114	2500
003		21	28x114	2500
004		1	28x114	2500
005		37	28x114	2444
007		17	28x114	2432
008		34	28x114	518
WA-1		1		
WB-1		1		
WC-1		1		
FH2	FUNDAMENTHÖLZER (imprägniert) 	4	70x45	2500
FH3	FUNDAMENTHÖLZER (imprägniert) 	4	70x45	2430
FH1	FUNDAMENTHÖLZER (imprägniert) 	6	70x45	2360
LE1	LEISTE 	1	120x18	2166
LE3	LEISTE 	2	120x18	228
LE6	LEISTE 	✓ 4	95x18	2280
LE4	LEISTE 	✓ 3	95x18	2166
LE2	LEISTE 	✓ 2	95x18	342
LE5	LEISTE 	✓ 1	58x18	2166
LE7	LEISTE 	2	15x28	1938
EP4	ECKPFOSTEN 	2	44x44	2270
EP3	ECKPFOSTEN 	3	44x44	2156
EP1	ECKPFOSTEN 	3	44x44	218
EP2	ECKPFOSTEN 	1	30x40	1938
PF2	PFETTEN 	2	44x145	3200
Kood	Varianta A 250x250+SD+Tmat26jal	File	Varianta A 250x250+SD+Tmat26jal	tre28.dwg/4

Pos	Teileliste		Stck	Profil (mm)	Länge (mm)
PF1			2	44x145	2400
	DACHBRETTER		49+1	113x18	3005
	FUSSBODENBRETTER		22+1	113x18	2440
	TERRASSENBRETTER (imprägniert)		27+1	90x18	2470
	FUSSBODENLEISTEN			18x40	10,0 lfdm
BL-1	DACHBLENDEN 336mm		2	18x336	2500
BL-2	DACHBLENDEN 336mm		2	18x336	2936
BL-3	DACHBLENDEN 336mm		2	18x336	3100
VL-1	DACHBLENDEN- Verbindungsleisten		2	18x120	336
BS-1	DACHBLENDEN- Blendenstützen 44x65		14	44x65	300
UPB-1	DACHBLENDEN- U-Profil für Blenden			65x44	18,0 lfdm
DPL-1	DACHPAPPENLEISTEN 15x28			15x28	12,0 lfdm
T06-1	TRAUFENLEISTEN 18x40			18x40	11,0 lfdm
TP68-1	STÜTZPFOSTEN 68x68		1	68x68	1940
TP68-2	STÜTZPFOSTEN 68x68		1	68x68	2050
SH	Schlaghölzer		3		
KP-1	DACHPAPPE			6,1m-4st.	25,0 lfdm
NG01	DACHPAPPNÄGEL 2.8x15		410		
NG04	NÄGEL 2.5x50	Dachbretter Fussbodenbretter, Terrassenbretter		936	
SR32	SCHRAUBEN 3.0x30	Dachpappenleisten, Verbindungsleisten Fussbodenleisten, Traufenleisten		82	
SR37	SCHRAUBEN 3.5x45	U-Profil LE1-LE7		196	
SR44	SCHRAUBEN 4.0x60	Wandbohlen zu Eckpfosten		416	
SR57	SCHRAUBEN 5.0x100	Fundamenthölzer		56	
SR55	SCHRAUBEN 5.0x70	Blendenbefestigung Blendestützen, EP1, EP3		56	
SR62	SCHRAUBEN 6.0x140 (ASSY für Pfetten)		4		
Kood	Varianta A 250x250+SD+T		Mat	Bjäl	
File	Varianta A 250x250+SD+T		tre	28.dwg/4	

Pos	Teileliste	Stck.	Profil (mm)	Länge (mm)
	<p style="text-align: center;"><b>TÜR 1425x1945</b> <b>D2-D28R-LLM-14251945</b></p> <p><b>Q2 D205-RM</b> 1425</p>  <div style="display: flex; justify-content: space-between;"> <div style="writing-mode: vertical-rl; transform: rotate(180deg);">1945</div> <div style="border: 1px solid black; padding: 5px;">                 Right handed / DIN rechts / paremakäeline             </div> <div style="border: 1px solid black; padding: 5px;">                 Clear opening/ durchgangsmaß/ ava suurus 1337x1857mm                  </div> <div style="border: 1px solid black; padding: 5px;">                 matt glass Floatglas Satinert matt klaas 492x382mm                  </div> </div>	1		
SR25 15-01	2.5x15 Locking plate - Schließblech - Riivi vastus 01 Q2-Q3		2	
SR50 90-01	5.0x90 Door frames - Türrahmen - Ukselengid		8	
RV01	Locking plate - Schließblech - Riivi vastus 01 Q2-Q3		1	
UL-Q 2-Q3	Q2-Q3 Door handle - Türgriff - Ukselink		1	
LS-Q4	Q4 Cylinder lock - Zylinderschloss - Lukusüdamik		1	
	✓ - bitte selber anpassen (falls nötig)!			
Kood	Varianta A 250x250+SD+T	Mat 20jal	File	Varianta A 250x250+SD+T
				tre 28.dwg / 4

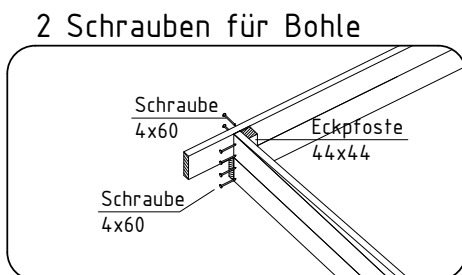
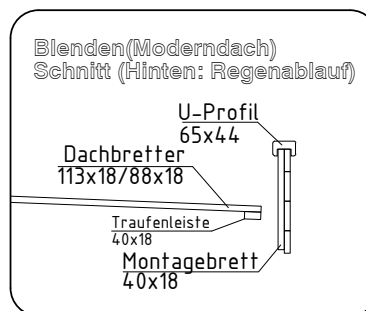
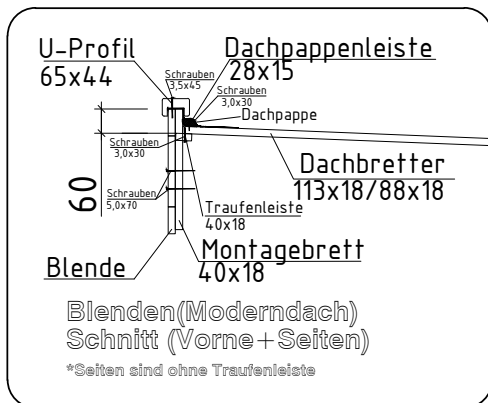
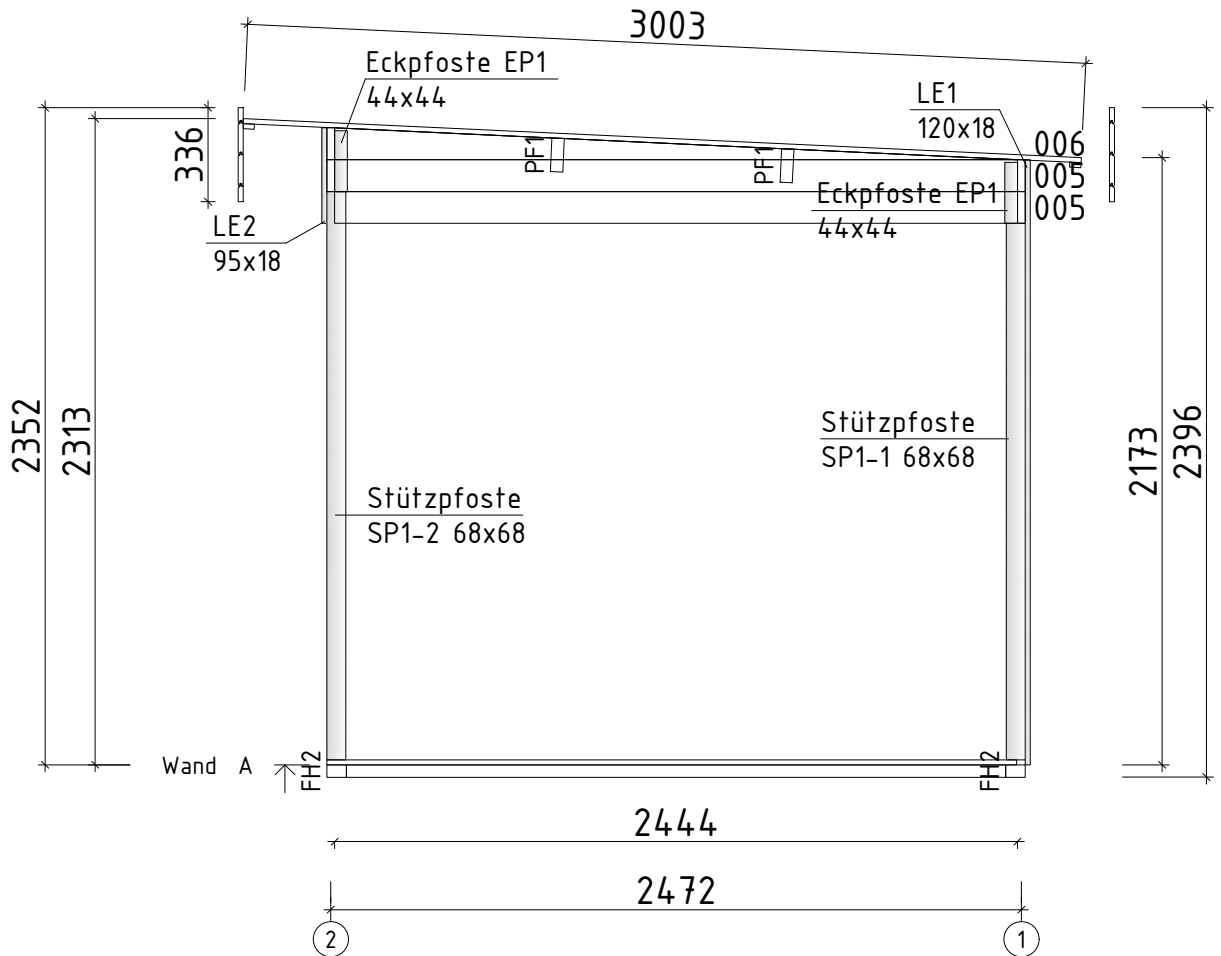



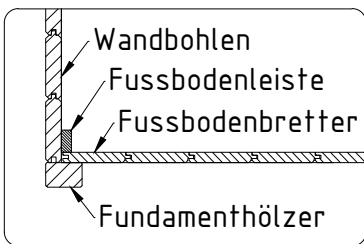
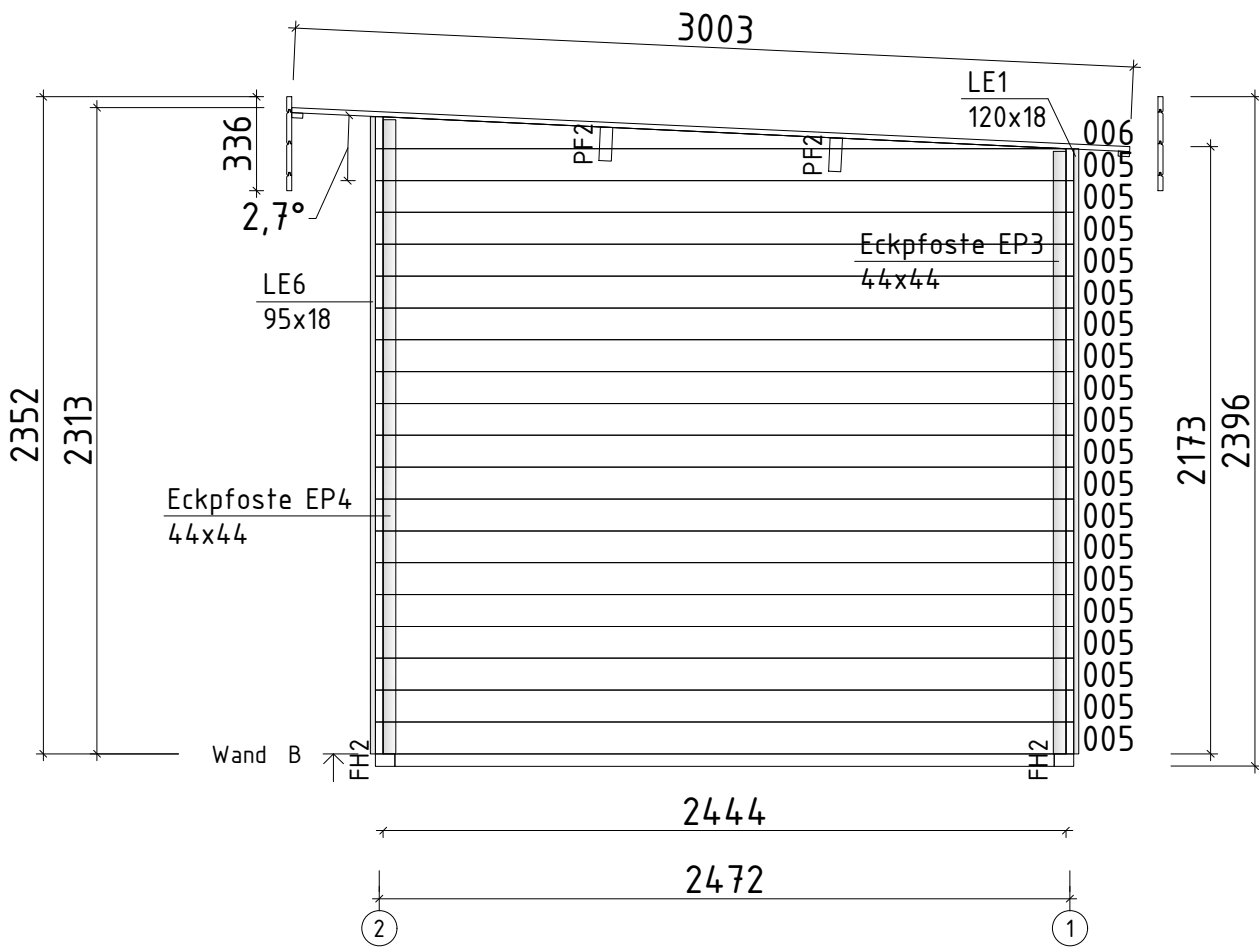

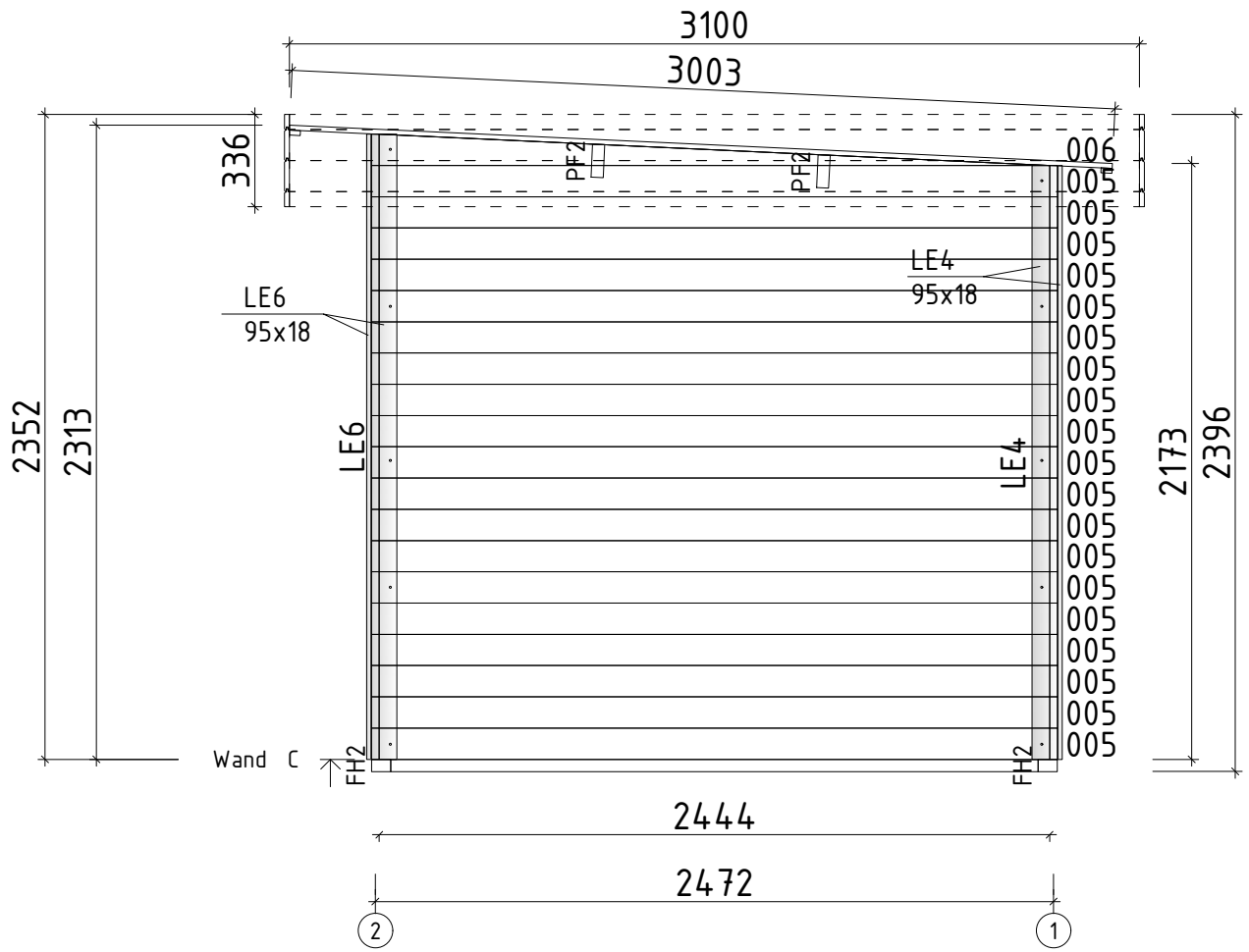

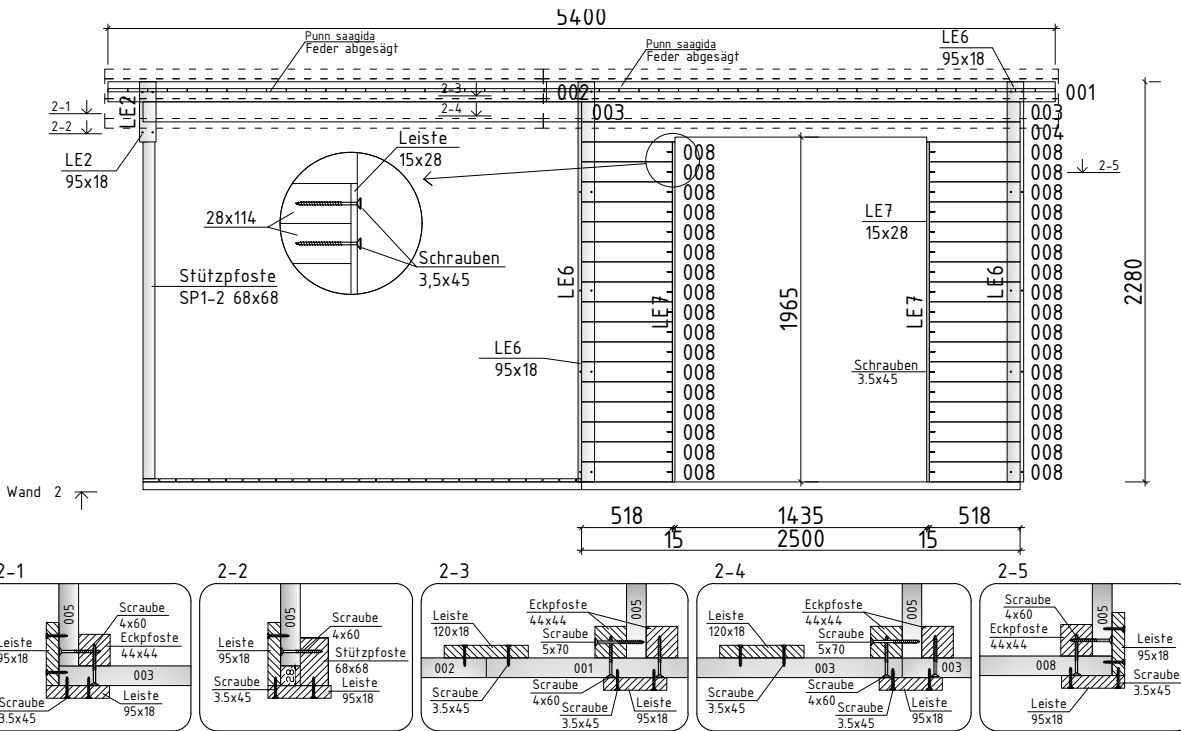
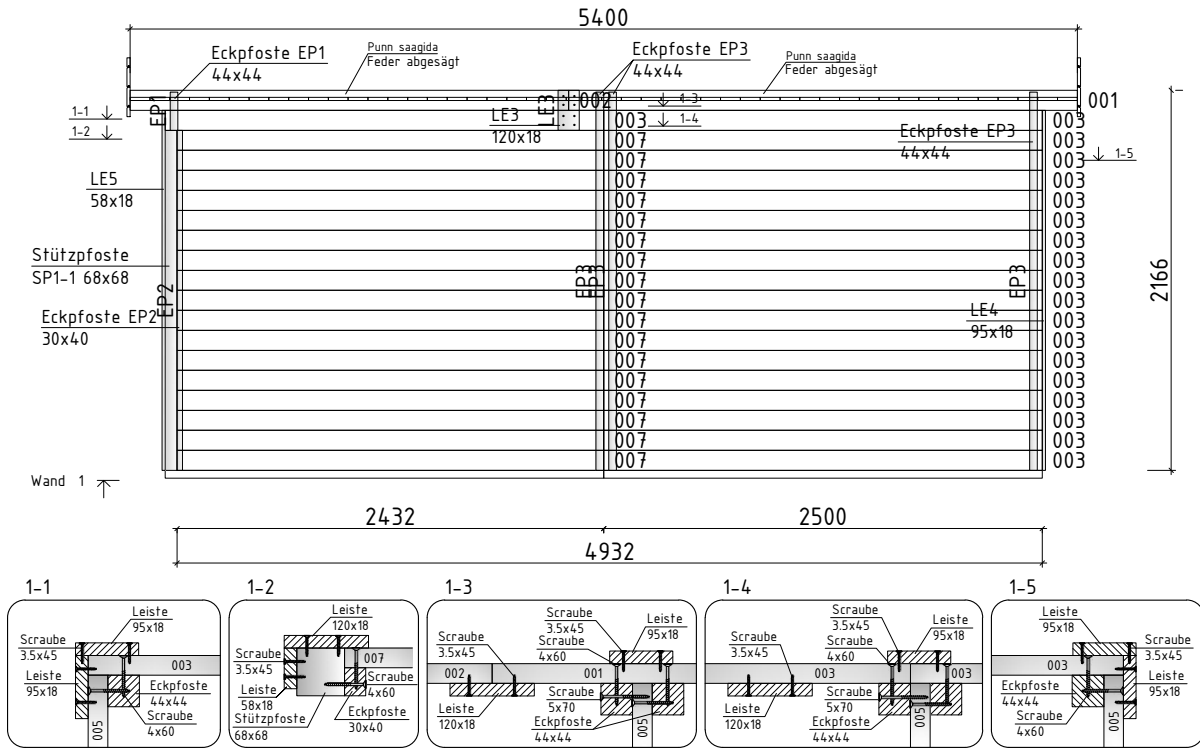

### Pärlinite ühendamine / Verbinden der Pfetten / Connecting purlins

**1**

Märkige kruvide asukohad /  
Markieren Sie die empfohlenen  
Schraubenpositionen /  
Mark the suggested positions  
for screws

Pärlin/Pfette/Purlin

Kruvi/Schraube/  
Screw 6x140

**2**

Keerake kruvid poole ulatuses sisse .  
(Vaja läheb Assy AW30 või Torx T30 otsikut) ⚙  
Drehen Sie die Schrauben bis zur Hälfte  
seiner Länge ein.  
(Für diese Schrauben benötigen Sie einen  
Assy AW30 oder Innentorx T30  
Schraubereinsatz) ⚙  
Turn the screws up  
until the first half.  
(These screws require Assy AW30  
or Torx T30 driver bit) ⚙

**3**

Hõia ühendatavad pärlinid tihedalt koos /  
Setzen Sie die Enden der Balken zusammen /  
Keep purlins tight together

**4**

Keera kruvid lõpuni sisse /  
Drehen Sie die Schrauben dann ganz ein /  
Turn the screws up until the end

<p>Uks      Q2-Q3   -   koostamisjuhised Door    Q2-Q3   -   assembly instructions Tür     Q2-Q3   -   Montageanleitung</p>		<p>1.</p> <p>2.</p>
		<p>2.</p>
<p>*Kui ühepoolne uks ei ole kokku pandud! *When single door is not assembled! *Wenn Einzeltür ist nicht zusammengebaut!</p>		<p>*Kui hinged ei ole paigaldatud! *When hinges are not attached! *Wenn Scharniere sind nicht angebracht!</p>

Plot date: 29.04.2020