

## Technische Daten: Art.-Nr.: 231 500

Wandaußenmaß: 250 x 250 cm

Bohlenstärke: 28 mm



Kontrolliert durch:

Achtung: Alle angegebenen Maße sind ca.-Maße!

# 3D-Darstellung Art.-Nr. 231 500

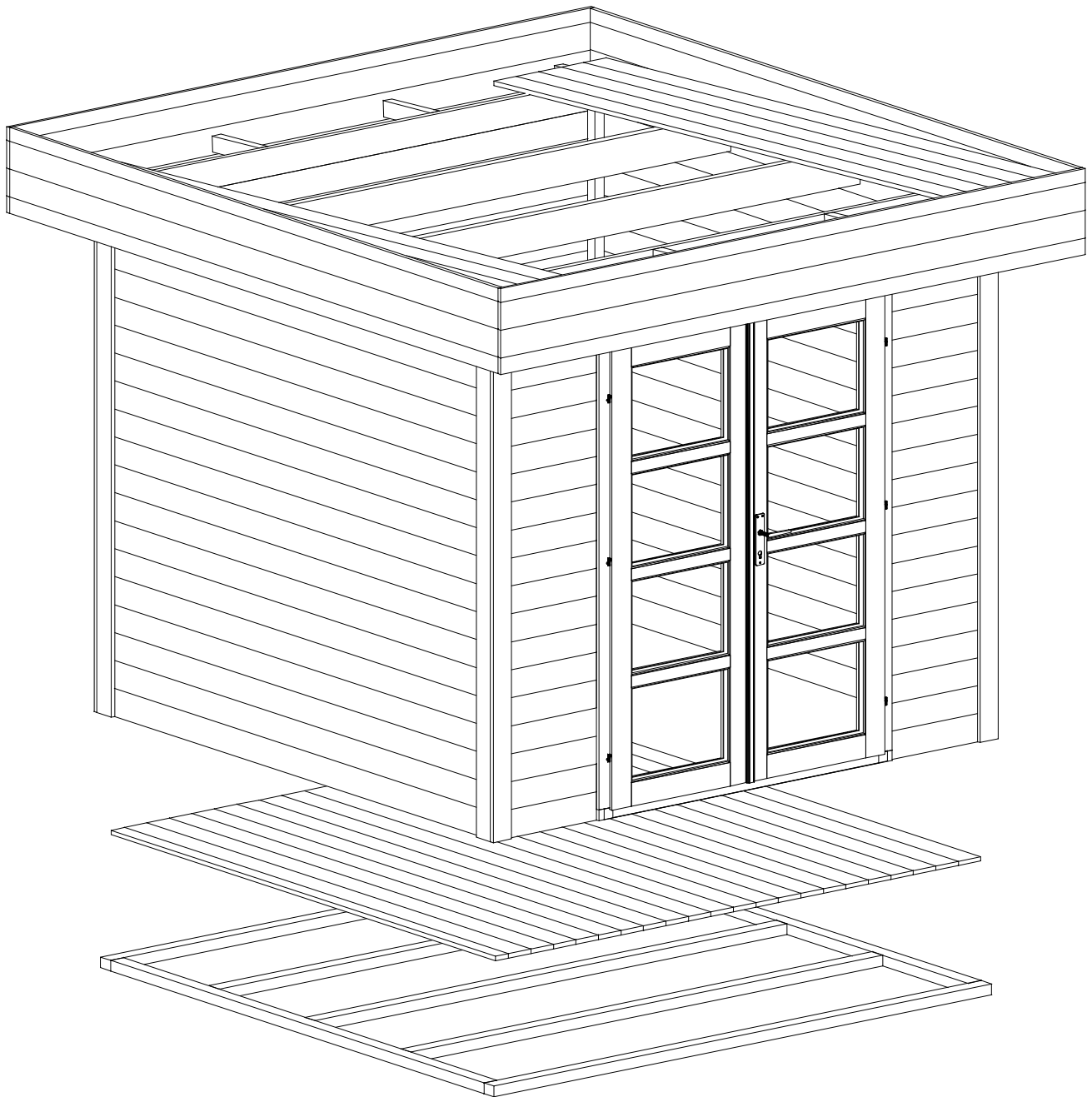



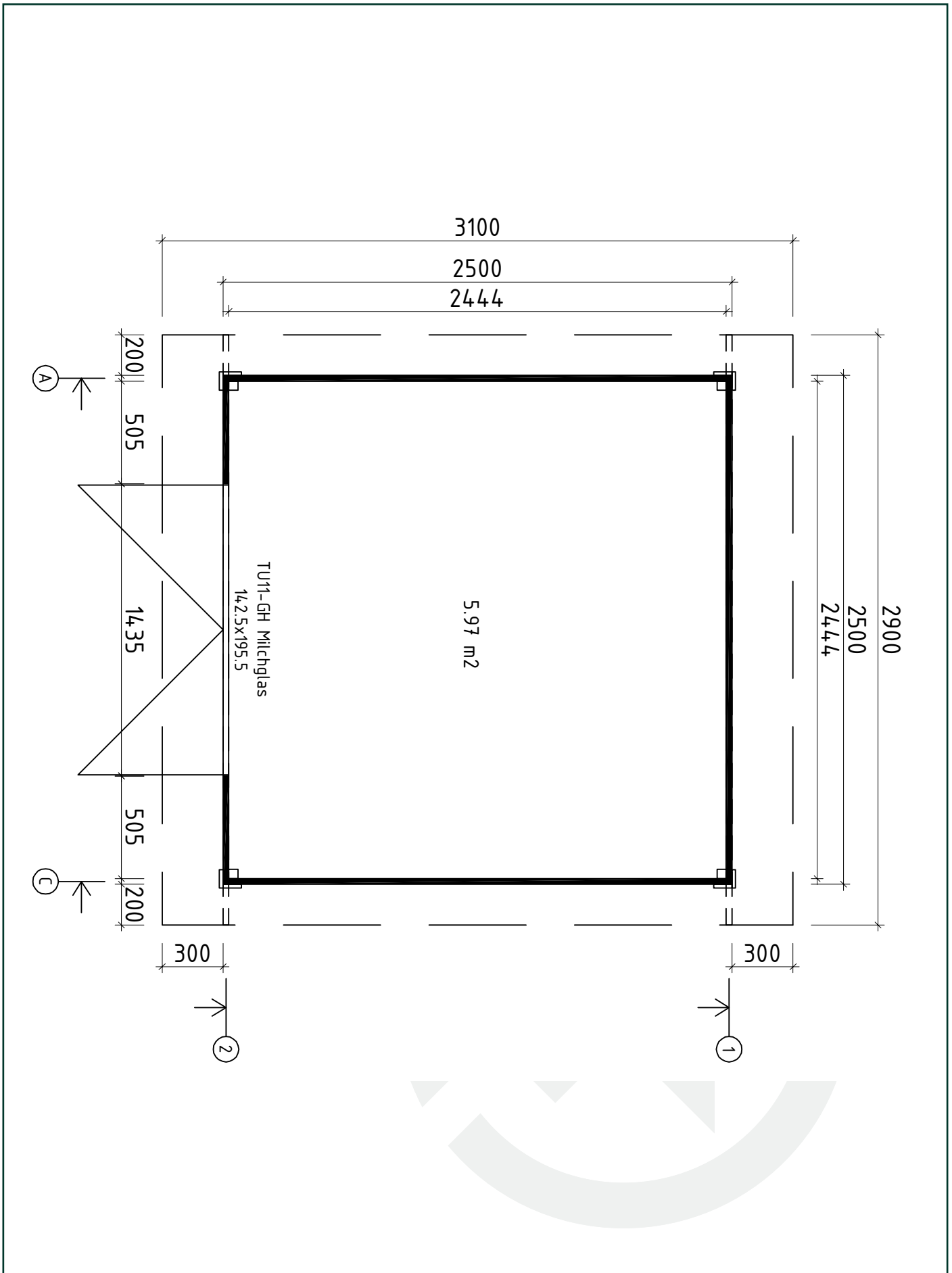







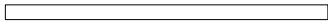
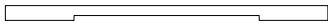
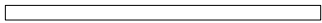









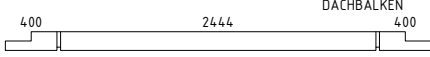

# Grundriss Art.-Nr. 231 500

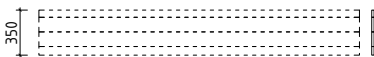



# Teileliste 1

## Art.-Nr. 231 500

Pos		Stck.	Profil (mm)	Länge (mm)
001		2	28x114	2900
002		19	28x114	2500
003		1	28x114	2500
004		38	28x114	2444
005		2	28x114	2444
006		34	28x114	518
FH2	FUNDAMENTHOLZER (imprägniert) 	2	65x44	2500
FH1	FUNDAMENTHOLZER (imprägniert) 	5	65x44	2370
LE2	LEISTE 	✓ 4	90x18	2280
LE1	LEISTE 	✓ 4	90x18	2166
LE3	LEISTE 	2	15x28	1938
EP1	ECKPFOSTEN 	2	45x45	2270
EP2	ECKPFOSTEN 	2	45x45	2156
DB1	DACHBALKEN 	✓ 2	44x145	3300
	DACHBRETTER 	26+1	113x18	3005
	FUSSBODENBRETTER 	22+1	113x18	2440
	FUSSBODENLEISTE 	✓	18x40	10,0 lfm
BL-1	DACHBLENDEN 350mm 	2	18x350	2936
BL-2	DACHBLENDEN 350mm 	2	18x350	3100
BS-1	DACHBLENDEN- Blendenstützen 44x65 	8	44x65	300
UPB-1	DACHBLENDEN- U-Profil für Blenden 	✓	65x44	13,0 lfm
DPL-1	DACHPAPPENLEISTE 15x28 	✓	15x28	9,0 lfm
T4-1	TRAUFENLEISTE 40x18 	✓	40x18	6,0 lfm
SH	Schlaghölzer 	3		
	DACHPAPPE 	✓	3,6m-4st.	15,0 lfm





# Wandplan 2

## Art.-Nr. 231 500

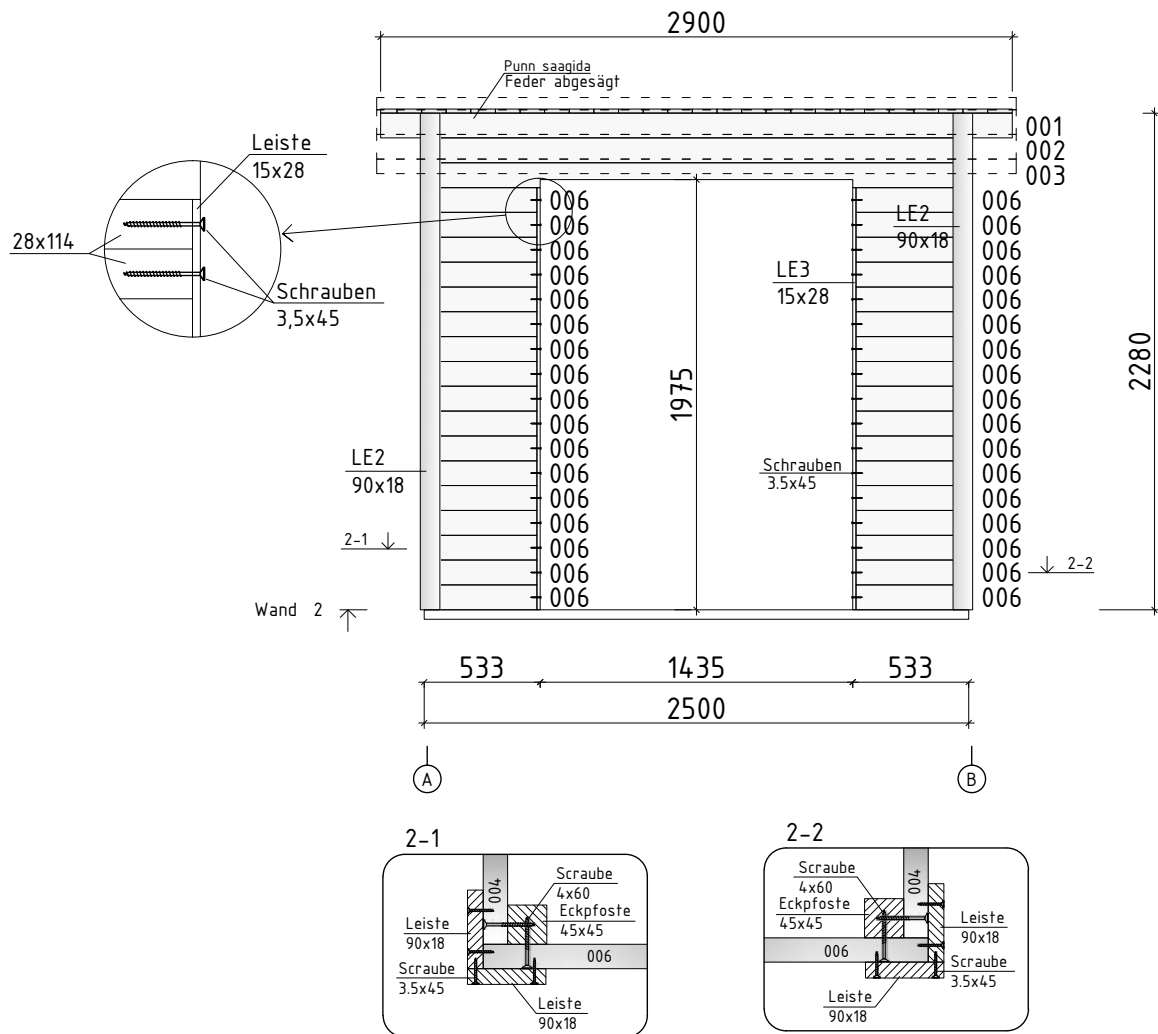



# Wandplan A Art.-Nr. 231 500

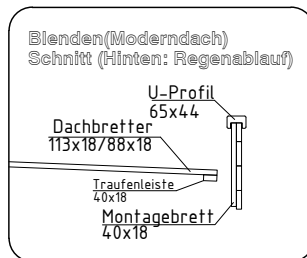
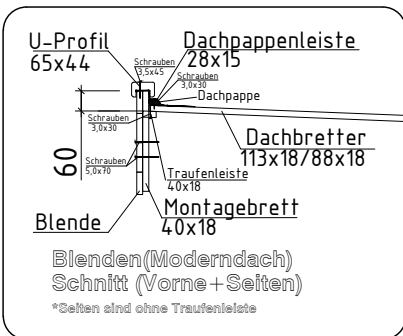
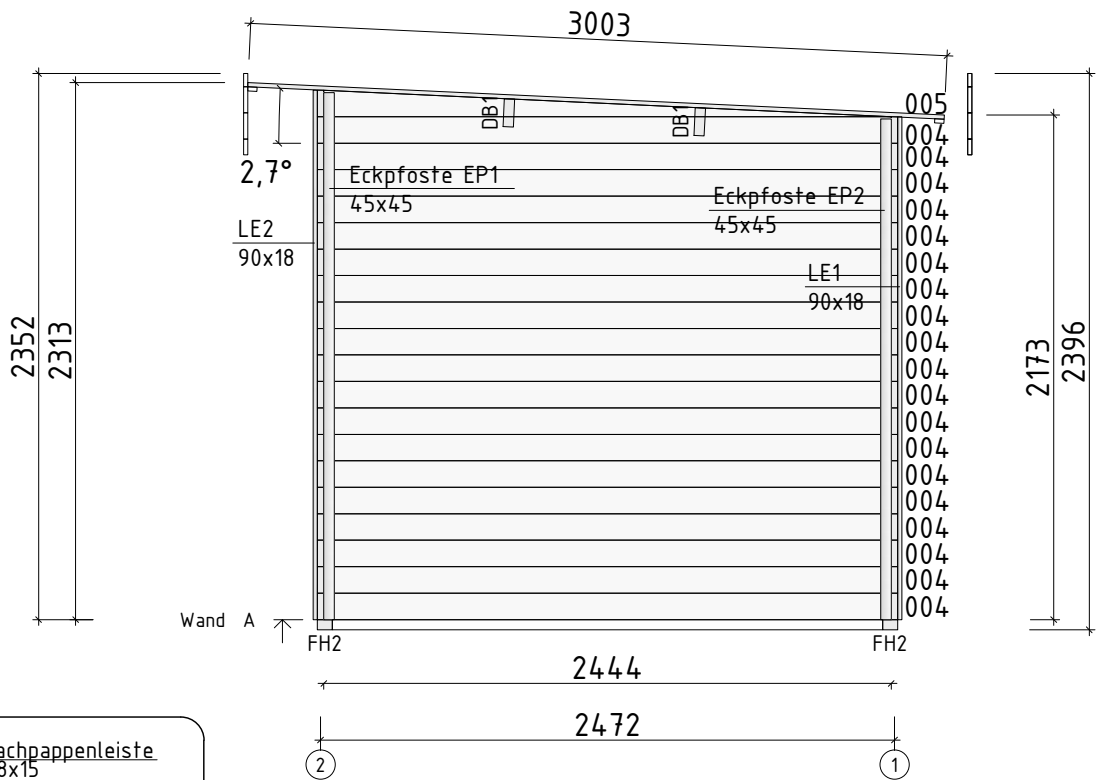

# Wandplan B

## Art.-Nr. 231 500

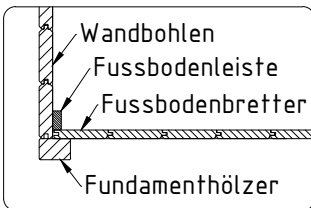
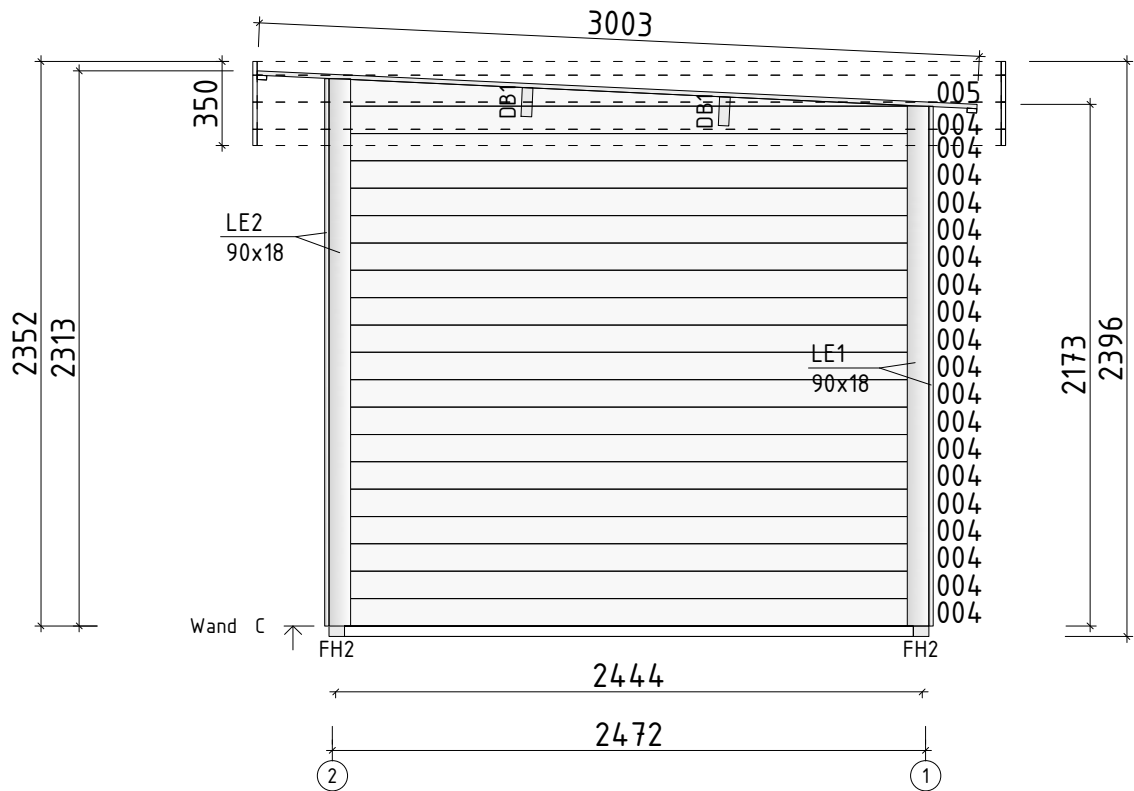

# Detailansicht

## Art.-Nr. 231 500

Die Dachbalken bei dem Haus sind länger als der Dachüberstand, damit das Seitendach als Zubehör montiert werden kann.

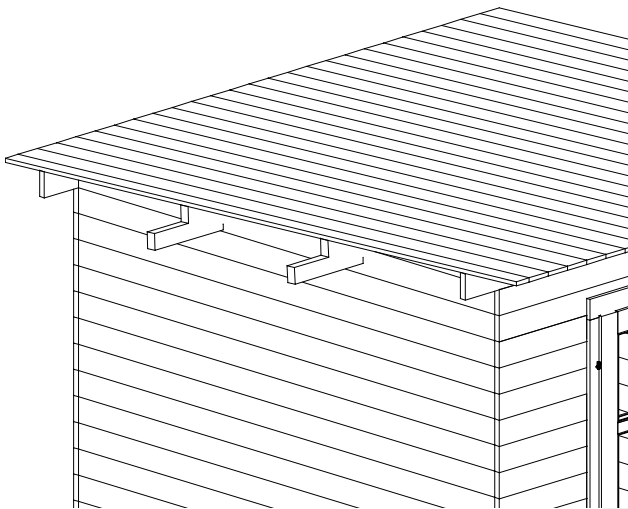

Falls kein Zubehör am Dach montiert werden soll, bitte die Enden der Dachbalken wie gezeigt absägen.

