









Mehr Produkte finden Sie  
in unserem Katalog!

Art. 228 290



# Lüttich B

28 mm / 270x200 cm / 5,4 m<sup>2</sup>

## DIMENSIONEN

	Bohlenstärke	28 mm
	Innenmaß	264x194 cm
	Sockelmaß	270x200 cm
	Gesamtmaß	310x240 cm
	Grundfläche	5,4 m <sup>2</sup>
	Rauminhalt	10,9 m <sup>3</sup>
	Wandhöhe vorne / hinten	vorne 222 cm hinten 183 cm
	Dachüberstand uml.	20 cm

## DACH

	Dachneigung	9°
	Dachfläche	7,4 m <sup>2</sup>
	Dachbretter	16 mm

## TÜR/ FENSTER

	Doppeltür (Normalglas)	134x187 cm
--	------------------------	------------

## VERPACKUNG

	Paketabmessung	315x120x47 cm
	Paketgewicht	386 kg

## ZUBEHÖR (zzgl.)

	Fußboden-Set*
	Dachpappe 1 x 10 m
	<b>Dachrinne</b>
	Kunststoff 201Ax braun
	Kunststoff 402Ax anthrazit
	2 Dichtungsbahn-Rollen
	Alu bis 300 cm mit 1 Fallrohr

**5 JAHRE  
GARANTIE**



## Grundriss

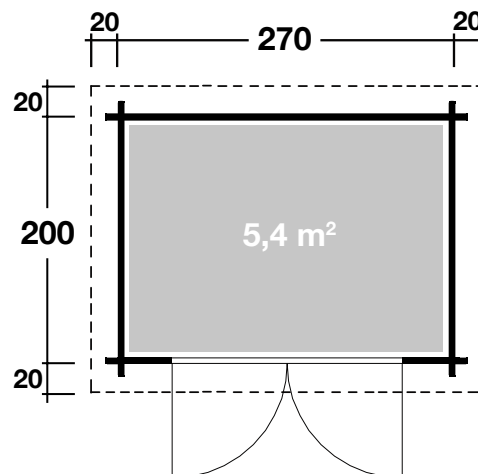

\*Fundamenthölzer sind im Fußboden-Set enthalten. Fundamenthölzer sind für die Langlebigkeit der Häuser empfehlenswert.

Weitere Informationen finden Sie unter: [www.finnhaus.de](http://www.finnhaus.de) oder im aktuellen Katalog. Technische Änderungen, Druckfehler und Irrtümer vorbehalten.